



Micro Commercial Components
 20736 Marilla Street Chatsworth
 CA 91311
 Phone: (818) 701-4933
 Fax: (818) 701-4939

SOD4001 THRU SOD4007

Features

- Low Current Leakage
- For Surface Mount Application
- Low Forward Surge Current

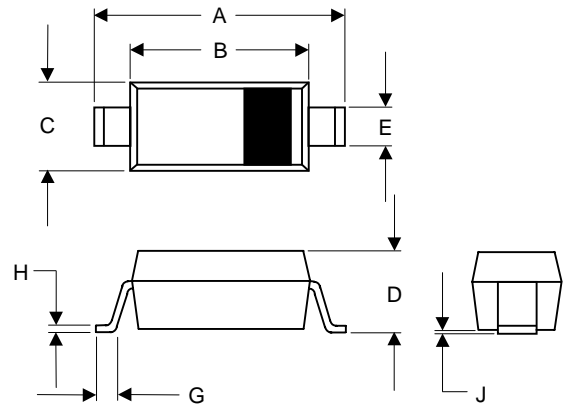
Maximum Ratings

- Operating Temperature: -55°C to +150°C
- Storage Temperature: -55°C to +150°C
- Maximum Thermal Resistance; 20°C/W Junction To Lead

MCC Part Number	Device Marking	Maximum Recurrent Peak Reverse Voltage	Maximum RMS Voltage	Maximum DC Blocking Voltage
SOD4001	S1	50V	35V	50V
SOD4002	S2	100V	70V	100V
SOD4003	S3	200V	140V	200V
SOD4004	S4	400V	280V	400V
SOD4005	S5	600V	420V	600V
SOD4006	S6	800V	560V	800V
SOD4007	S7	1000V	700V	1000V

1 Amp Standard Recovery Rectifier 50 to 1000 Volts

SOD-123



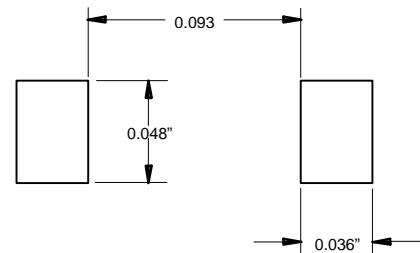
DIM	INCHES		MM		NOTE
	MIN	MAX	MIN	MAX	
A	.140	.152	3.55	3.85	
B	.100	.112	2.55	2.85	
C	.055	.071	1.40	1.80	
D	-----	.053	-----	1.35	
E	.012	.031	0.30	.78	
G	.006	-----	0.15	-----	
H	-----	.01	-----	.25	
J	-----	.006	-----	.15	

Electrical Characteristics @ 25°C Unless Otherwise Specified

Average Forward Current	$I_{F(AV)}$	1.0A	$T_A = 75^\circ\text{C}$
Peak Forward Surge Current	I_{FSM}	8.0A	8.3ms, half sine
Maximum Instantaneous Forward Voltage	V_F	1.3V	$I_{FM} = 1.0\text{A}; T_J = 25^\circ\text{C}^*$
Maximum DC Reverse Current At Rated DC Blocking Voltage	I_R	5.0 μA 50 μA	$T_J = 25^\circ\text{C}$ $T_J = 125^\circ\text{C}$
Typical Junction Capacitance	C_J	15pF	Measured at 1.0MHz, $V_R=4.0\text{V}$

*Pulse test: Pulse width 300 μsec , Duty cycle 2%

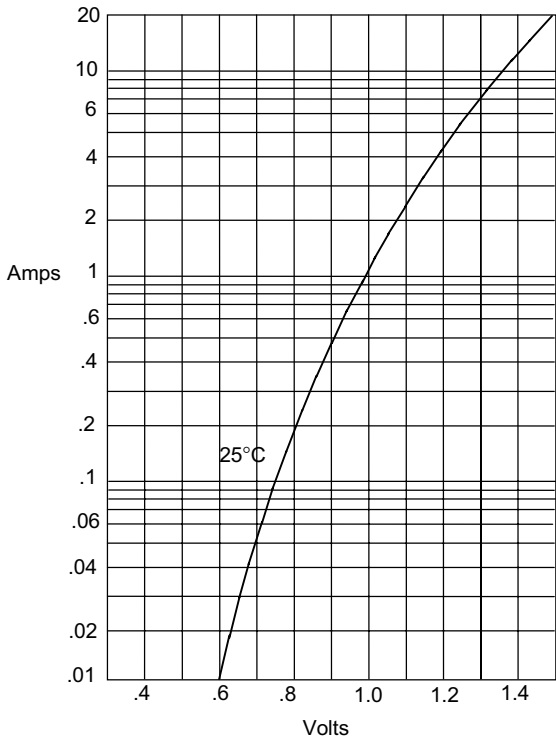
SUGGESTED SOLDER PAD LAYOUT



SOD4001 thru SOD4007

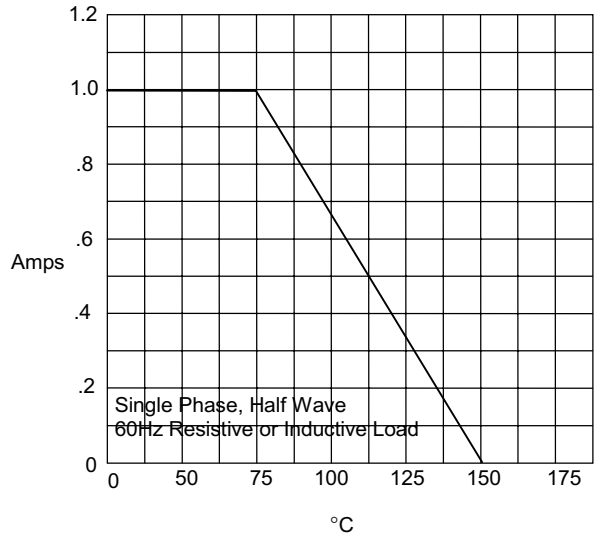


Figure 1
Typical Forward Characteristics



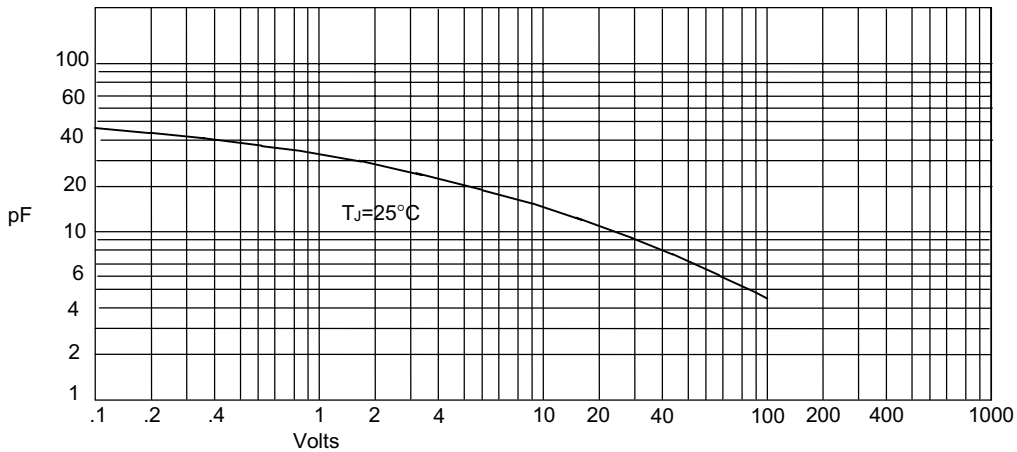
Instantaneous Forward Current - Amperes versus
Instantaneous Forward Voltage - Volts

Figure 2
Forward Derating Curve



Average Forward Rectified Current - Amperes versus
Ambient Temperature - °C

Figure 3
Junction Capacitance



Junction Capacitance - pF versus
Reverse Voltage - Volts

SOD4001 thru SOD4007

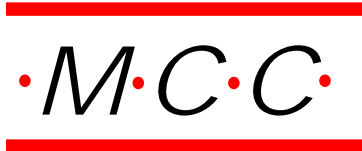
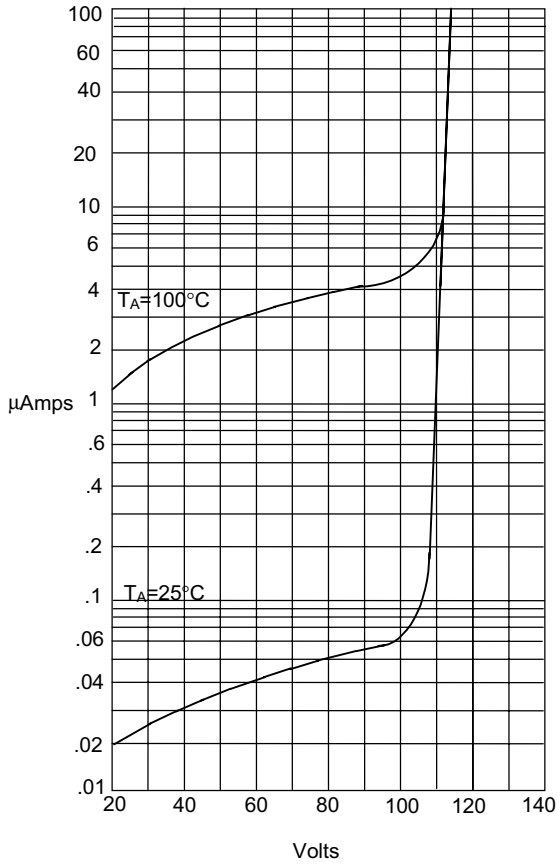
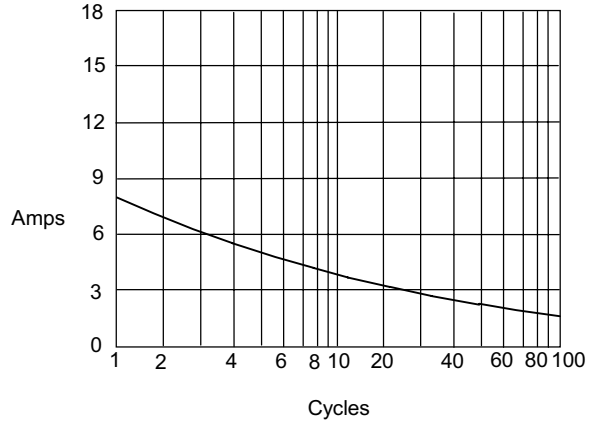


Figure 4
Typical Reverse Characteristics



Instantaneous Reverse Leakage Current - MicroAmperes versus
Percent Of Rated Peak Reverse Voltage - Volts

Figure 5
Peak Forward Surge Current



Peak Forward Surge Current - Amperes versus
Number Of Cycles At 60Hz - Cycles