

The RF MOSFET Line

RF Power Field Effect Transistor

N-Channel Enhancement-Mode Lateral MOSFETs

MRF1517T1

The MRF1517T1 is designed for broadband commercial and industrial applications at frequencies to 520 MHz. The high gain and broadband performance of this device makes it ideal for large-signal, common source amplifier applications in 7.5 volt portable FM equipment.

- Specified Performance @ 520 MHz, 7.5 Volts
 - Output Power — 8 Watts
 - Power Gain — 11 dB
 - Efficiency — 55%
- Characterized with Series Equivalent Large-Signal Impedance Parameters
- Excellent Thermal Stability
- Capable of Handling 20:1 VSWR, @ 9.5 Vdc, 520 MHz, 2 dB Overdrive
- Broadband UHF/VHF Demonstration Amplifier Information Available Upon Request
- RF Power Plastic Surface Mount Package
- Available in Tape and Reel.
 - T1 Suffix = 1,000 Units per 12 mm, 7 Inch Reel.

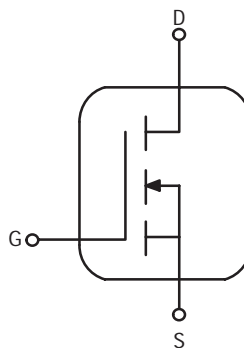

520 MHz, 8 W, 7.5 V
LATERAL N-CHANNEL
BROADBAND
RF POWER MOSFET

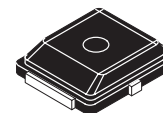

CASE 466-02, STYLE 1
(PLD-1.5)
PLASTIC

MAXIMUM RATINGS

Rating	Symbol	Value	Unit
Drain-Source Voltage (1)	V _{DSS}	25	Vdc
Gate-Source Voltage	V _{GS}	±20	Vdc
Drain Current — Continuous	I _D	4	Adc
Total Device Dissipation @ T _C = 25°C (2) Derate above 25°C	P _D	62.5 0.50	Watts W/°C
Storage Temperature Range	T _{stg}	-65 to +150	°C
Operating Junction Temperature	T _J	150	°C

THERMAL CHARACTERISTICS

Characteristic	Symbol	Max	Unit
Thermal Resistance, Junction to Case	R _{θJC}	2	°C/W

(1) Not designed for 12.5 volt applications.

(2) Calculated based on the formula $P_D = \frac{T_J - T_C}{R_{\theta JC}}$

NOTE – CAUTION – MOS devices are susceptible to damage from electrostatic charge. Reasonable precautions in handling and packaging MOS devices should be observed.

ELECTRICAL CHARACTERISTICS ($T_C = 25^\circ\text{C}$ unless otherwise noted)

Characteristic	Symbol	Min	Typ	Max	Unit
----------------	--------	-----	-----	-----	------

OFF CHARACTERISTICS

Zero Gate Voltage Drain Current ($V_{DS} = 35\text{ Vdc}$, $V_{GS} = 0$)	I_{DSS}	—	—	1	μA_{dc}
Gate–Source Leakage Current ($V_{GS} = 10\text{ Vdc}$, $V_{DS} = 0$)	I_{GSS}	—	—	1	μA_{dc}

ON CHARACTERISTICS

Gate Threshold Voltage ($V_{DS} = 7.5\text{ Vdc}$, $I_D = 120\ \mu\text{A}_{dc}$)	$V_{GS(th)}$	1.0	1.7	2.1	Vdc
Drain–Source On–Voltage ($V_{GS} = 10\text{ Vdc}$, $I_D = 1\text{ Adc}$)	$V_{DS(on)}$	—	0.5	—	Vdc
Forward Transconductance ($V_{DS} = 10\text{ Vdc}$, $I_D = 2\text{ Adc}$)	g_{fs}	0.9	—	—	S

DYNAMIC CHARACTERISTICS

Input Capacitance ($V_{DS} = 7.5\text{ Vdc}$, $V_{GS} = 0$, $f = 1\text{ MHz}$)	C_{iss}	—	66	—	pF
Output Capacitance ($V_{DS} = 7.5\text{ Vdc}$, $V_{GS} = 0$, $f = 1\text{ MHz}$)	C_{oss}	—	38	—	pF
Reverse Transfer Capacitance ($V_{DS} = 7.5\text{ Vdc}$, $V_{GS} = 0$, $f = 1\text{ MHz}$)	C_{rss}	—	6	—	pF

FUNCTIONAL TESTS (In Motorola Test Fixture)

Common–Source Amplifier Power Gain ($V_{DD} = 7.5\text{ Vdc}$, $P_{out} = 8\text{ Watts}$, $I_{DQ} = 150\text{ mA}$, $f = 520\text{ MHz}$)	G_{ps}	10	11	—	dB
Drain Efficiency ($V_{DD} = 7.5\text{ Vdc}$, $P_{out} = 8\text{ Watts}$, $I_{DQ} = 150\text{ mA}$, $f = 520\text{ MHz}$)	η	50	55	—	%

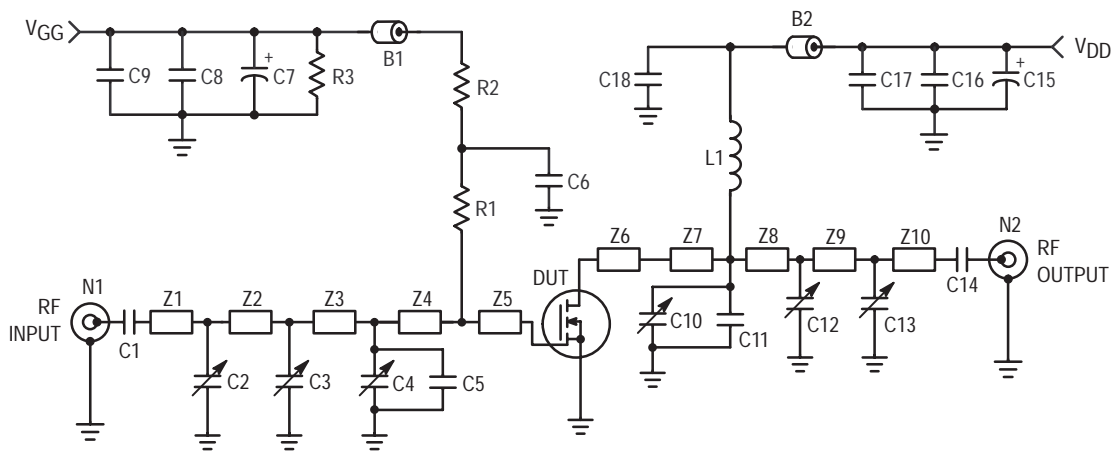

B1, B2	Short Ferrite Bead, Fair Rite Products (2743021446)	R1	15 Ω , 0805 Chip Resistor
C1	300 pF, 100 mil Chip Capacitor	R2	1.0 k Ω , 1/8 W Resistor
C2, C3, C4, C10,	0 to 20 pF, Trimmer Capacitor	R3	33 k Ω , 1/2 W Resistor
C12, C13	0 to 20 pF, Trimmer Capacitor	Z1	0.315" x 0.080" Microstrip
C5, C11	43 pF, 100 mil Chip Capacitor	Z2	1.415" x 0.080" Microstrip
C6, C18	120 pF, 100 mil Chip Capacitor	Z3	0.322" x 0.080" Microstrip
C7, C15	10 μ F, 50 V Electrolytic Capacitor	Z4	0.022" x 0.080" Microstrip
C8, C16	0.1 μ F, 100 mil Chip Capacitor	Z5, Z6	0.260" x 0.223" Microstrip
C9, C17	1,000 pF, 100 mil Chip Capacitor	Z7	0.050" x 0.080" Microstrip
C14	330 pF, 100 mil Chip Capacitor	Z8	0.625" x 0.080" Microstrip
L1	55.5 nH, 5 Turn, Coilcraft	Z9	0.800" x 0.080" Microstrip
N1, N2	Type N Flange Mount	Z10	0.589" x 0.080" Microstrip
		Board	Glass Teflon [®] , 31 mils, 2 oz. Copper

Figure 1. 480 – 520 MHz Broadband Test Circuit

TYPICAL CHARACTERISTICS, 480 – 520 MHz

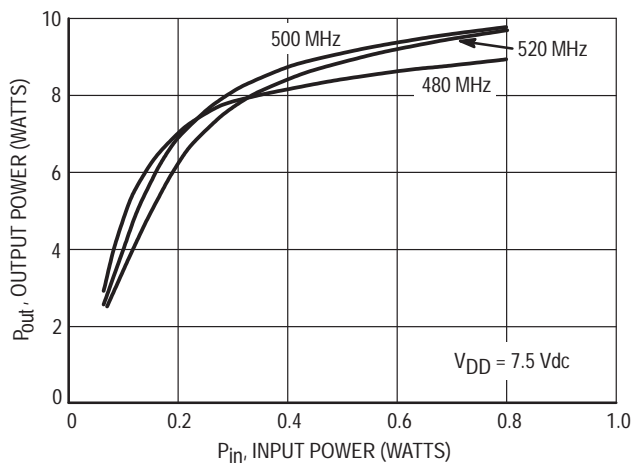

Figure 2. Output Power versus Input Power

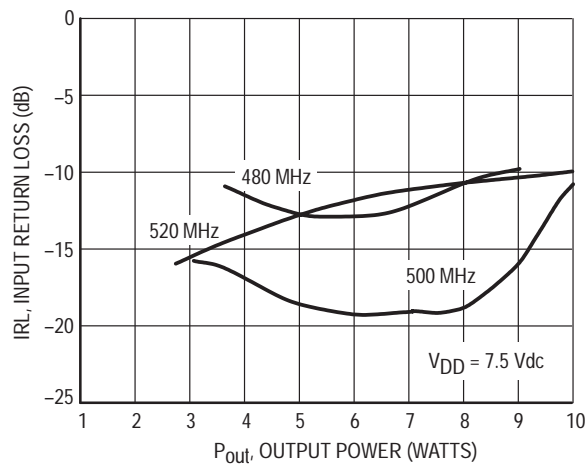

Figure 3. Input Return Loss versus Output Power

TYPICAL CHARACTERISTICS, 480 – 520 MHz

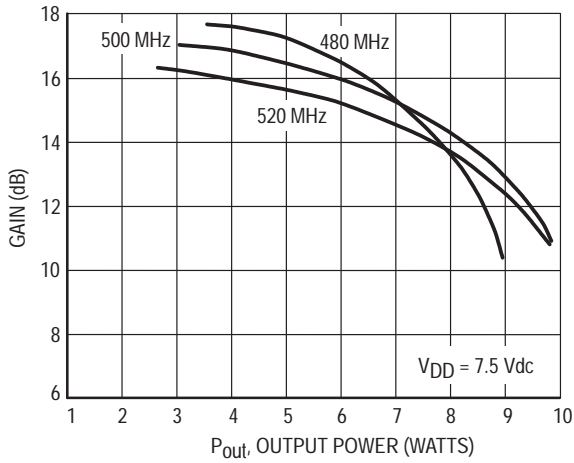

Figure 4. Gain versus Output Power

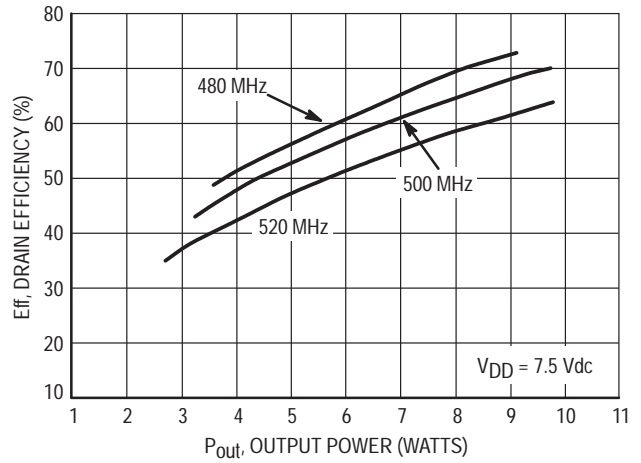

Figure 5. Drain Efficiency versus Output Power

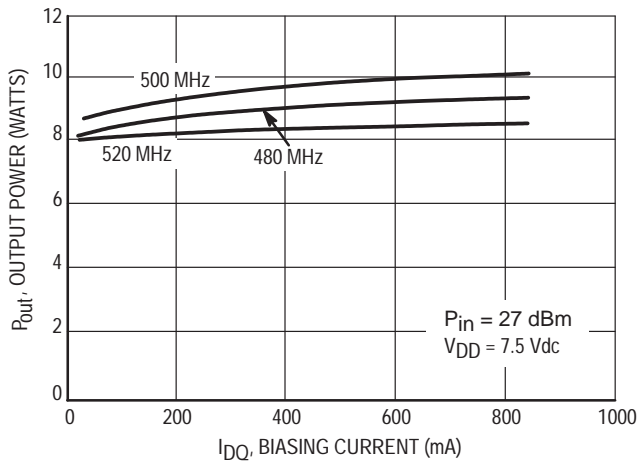

Figure 6. Output Power versus Biasing Current

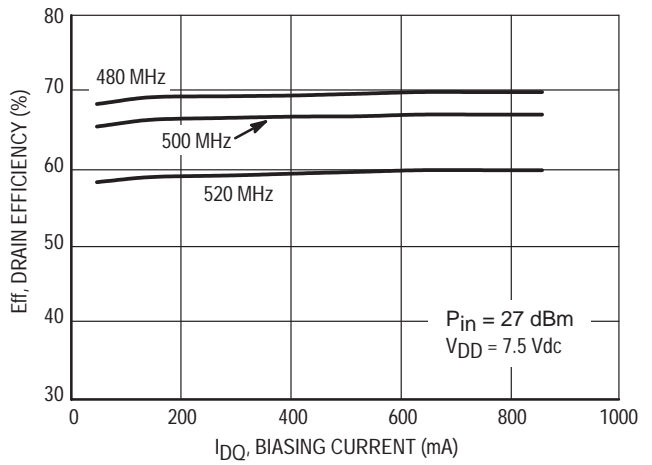

Figure 7. Drain Efficiency versus Biasing Current

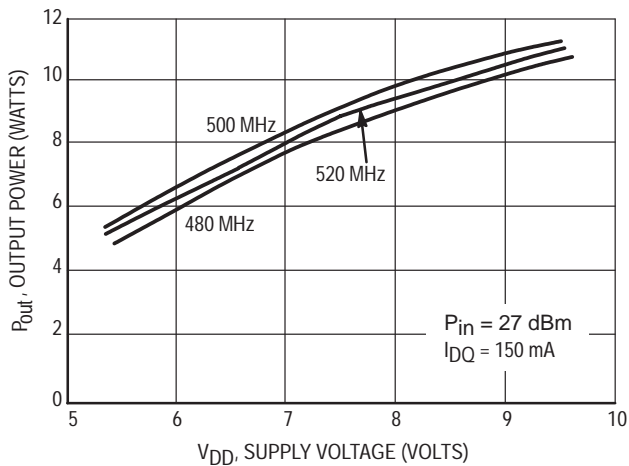

Figure 8. Output Power versus Supply Voltage

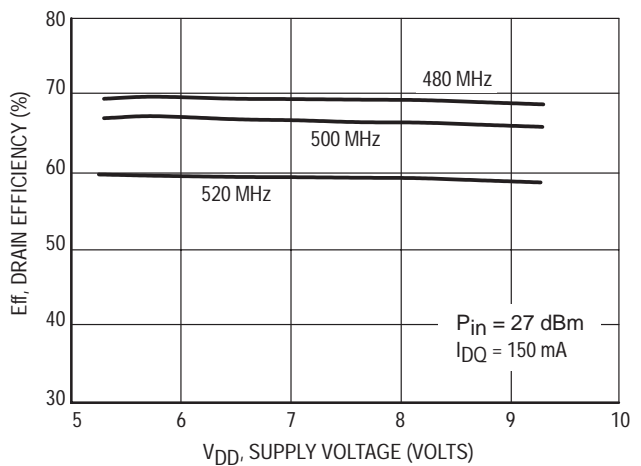
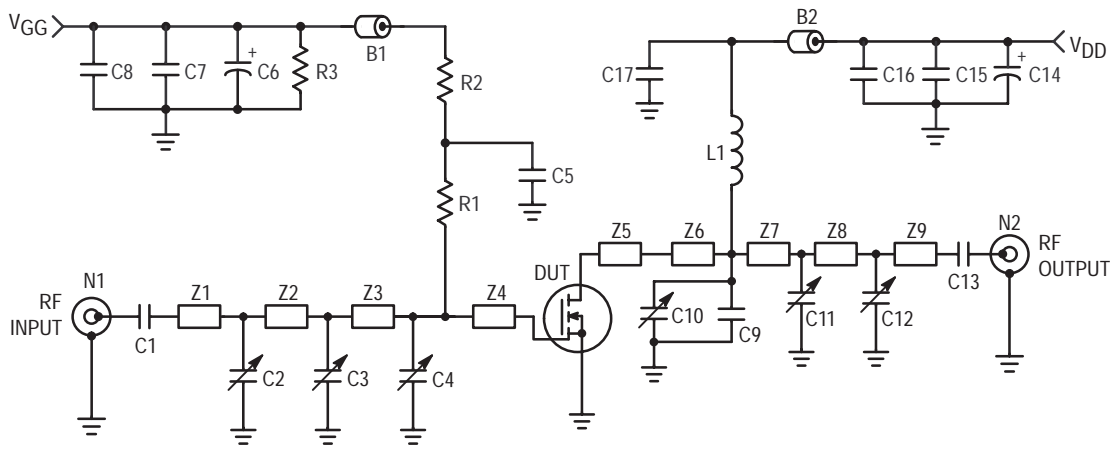

Figure 9. Drain Efficiency versus Supply Voltage



B1, B2	Short Ferrite Bead, Fair Rite Products (2743021446)	R1	12 Ω , 0805 Chip Resistor
C1, C13	300 pF, 100 mil Chip Capacitor	R2	1.0 k Ω , 1/8 W Resistor
C2, C3, C4, C10,	0 to 20 pF, Trimmer Capacitor	R3	33 k Ω , 1/2 W Resistor
C11, C12	0 to 20 pF, Trimmer Capacitor	Z1	0.617" x 0.080" Microstrip
C5, C17	130 pF, 100 mil Chip Capacitor	Z2	0.723" x 0.080" Microstrip
C6, C14	10 μ F, 50 V Electrolytic Capacitor	Z3	0.513" x 0.080" Microstrip
C7, C15	0.1 μ F, 100 mil Chip Capacitor	Z4, Z5	0.260" x 0.223" Microstrip
C8, C16	1,000 pF, 100 mil Chip Capacitor	Z6	0.048" x 0.080" Microstrip
C9	33 pF, 100 mil Chip Capacitor	Z7	0.577" x 0.080" Microstrip
L1	55.5 nH, 5 Turn, Coilcraft	Z8	1.135" x 0.080" Microstrip
N1, N2	Type N Flange Mount	Z9	0.076" x 0.080" Microstrip
		Board	Glass Teflon [®] , 31 mils, 2 oz. Copper

Figure 10. 400 – 440 MHz Broadband Test Circuit

TYPICAL CHARACTERISTICS, 400 – 440 MHz

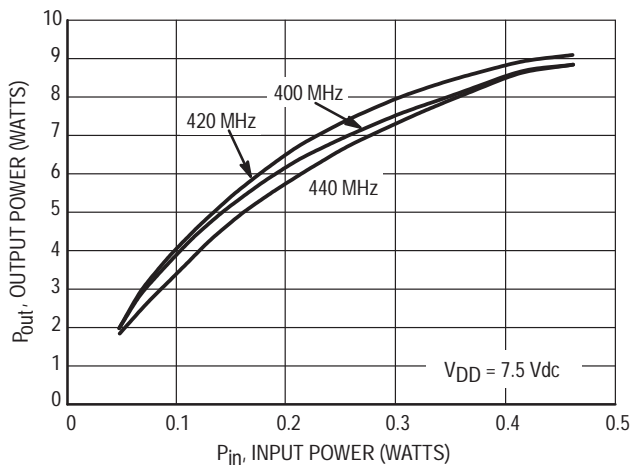

Figure 11. Output Power versus Input Power

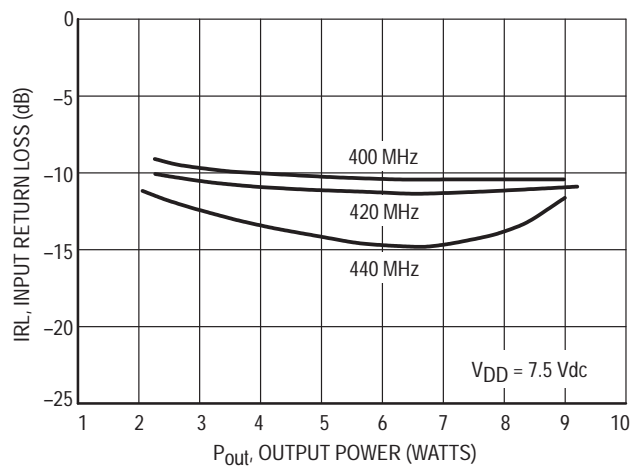

Figure 12. Input Return Loss versus Output Power

TYPICAL CHARACTERISTICS, 400 – 440 MHz

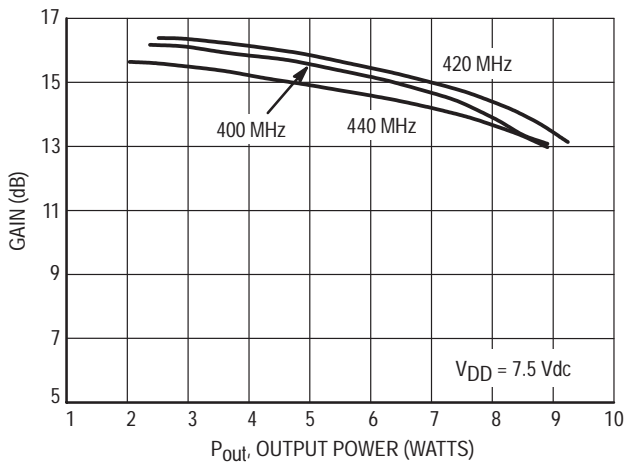

Figure 13. Gain versus Output Power

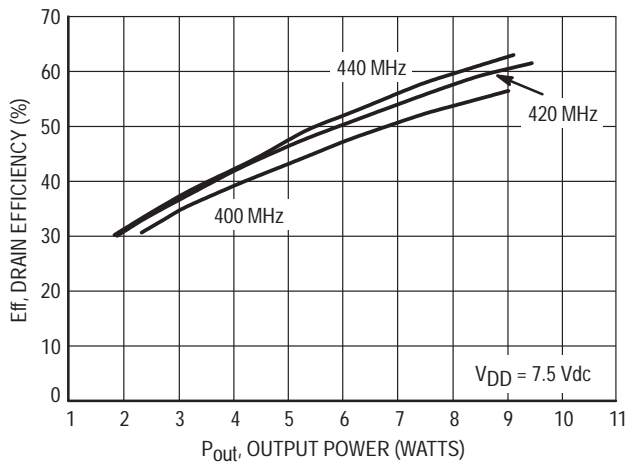

Figure 14. Drain Efficiency versus Output Power

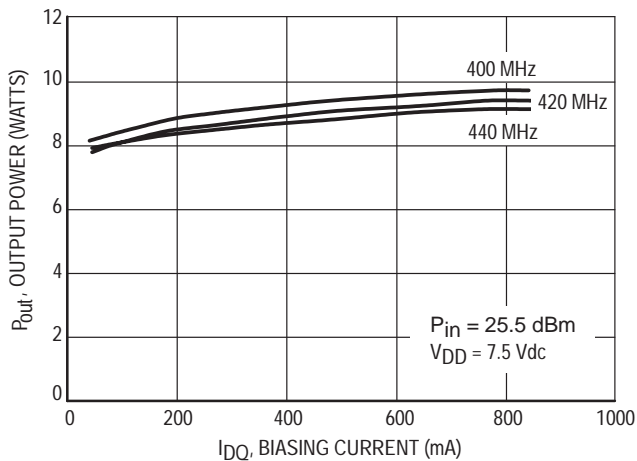

Figure 15. Output Power versus Biasing Current

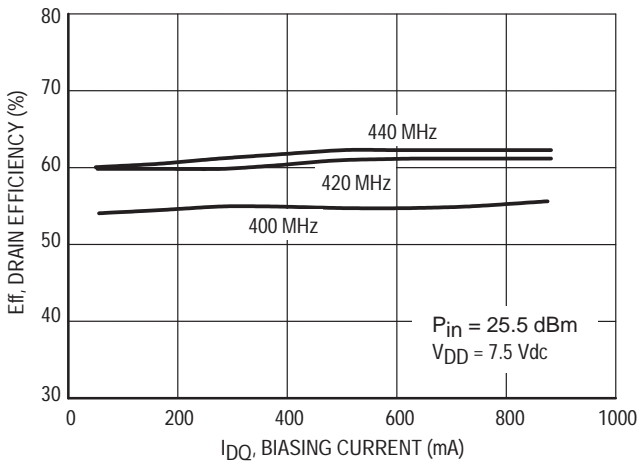

Figure 16. Drain Efficiency versus Biasing Current

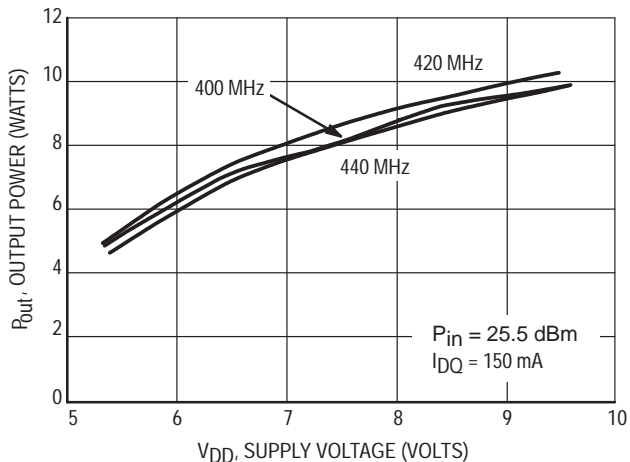

Figure 17. Output Power versus Supply Voltage

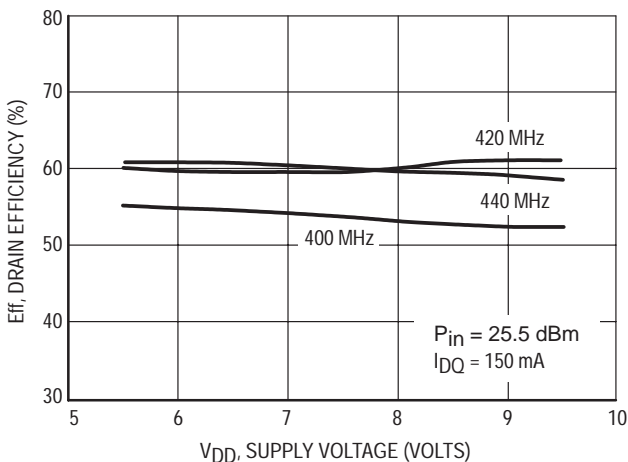
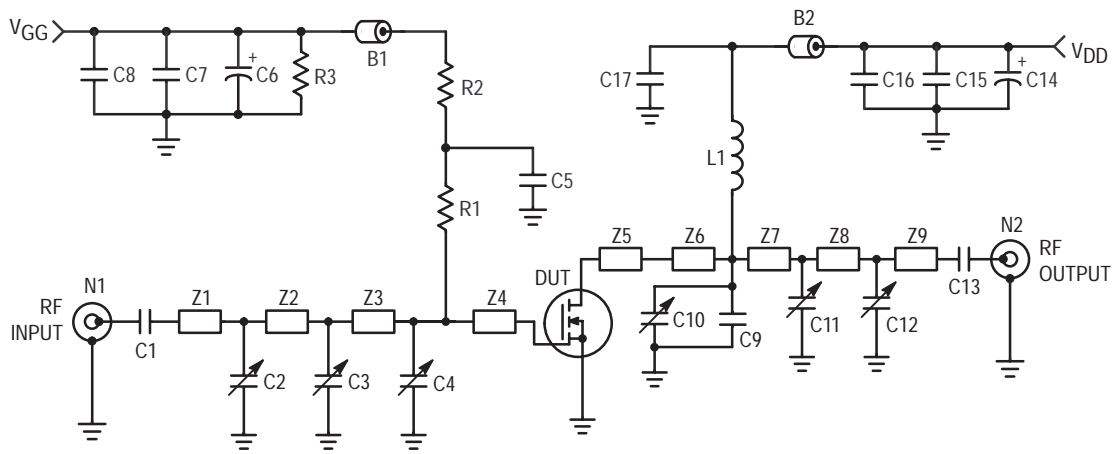

Figure 18. Drain Efficiency versus Supply Voltage



B1, B2	Short Ferrite Bead, Fair Rite Products (2743021446)	R1	15 Ω , 0805 Chip Resistor
C1	240 pF, 100 mil Chip Capacitor	R2	1.0 k Ω , 1/8 W Resistor
C2, C3, C4, C10,	0 to 20 pF, Trimmer Capacitor	R3	33 k Ω , 1/2 W Resistor
C11, C12	0 to 20 pF, Trimmer Capacitor	Z1	0.471" x 0.080" Microstrip
C5, C17	130 pF, 100 mil Chip Capacitor	Z2	1.082" x 0.080" Microstrip
C6, C14	10 mF, 50 V Electrolytic Capacitor	Z3	0.372" x 0.080" Microstrip
C7, C15	0.1 mF, 100 mil Chip Capacitor	Z4, Z5	0.260" x 0.223" Microstrip
C8, C16	1,000 pF, 100 mil Chip Capacitor	Z6	0.050" x 0.080" Microstrip
C9	39 pF, 100 mil Chip Capacitor	Z7	0.551" x 0.080" Microstrip
C13	330 pF, 100 mil Chip Capacitor	Z8	0.825" x 0.080" Microstrip
L1	55.5 nH, 5 Turn, Coilcraft	Z9	0.489" x 0.080" Microstrip
N1, N2	Type N Flange Mount	Board	Glass Teflon [®] , 31 mils, 2 oz. Copper

Figure 19. 440 – 480 MHz Broadband Test Circuit

TYPICAL CHARACTERISTICS, 440 – 480 MHz

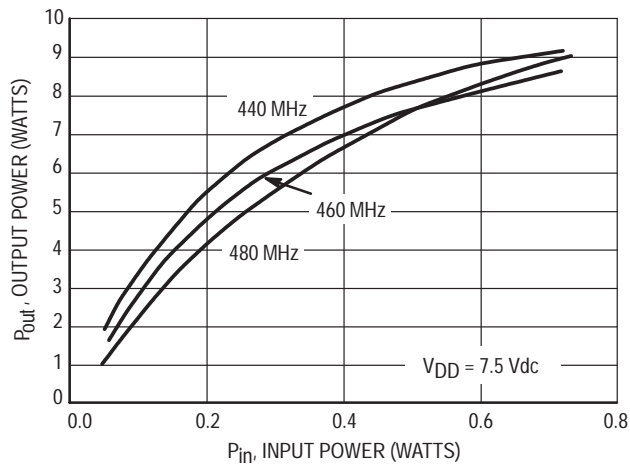

Figure 20. Output Power versus Input Power

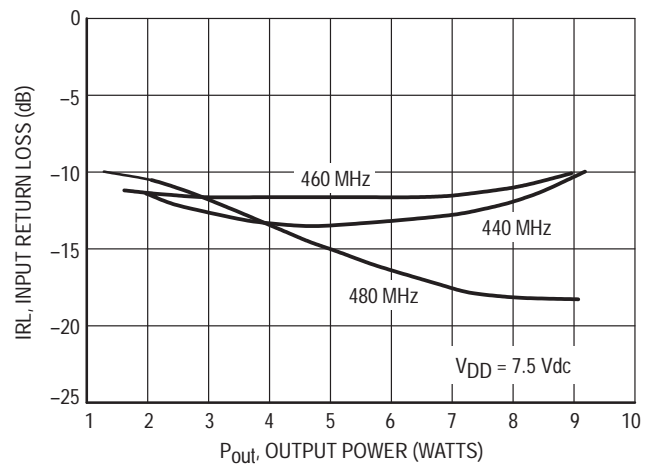

Figure 21. Input Return Loss versus Output Power

TYPICAL CHARACTERISTICS, 440 – 480 MHz

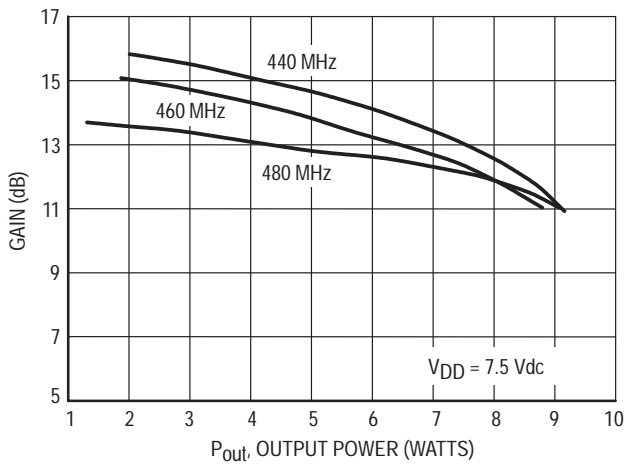

Figure 22. Gain versus Output Power

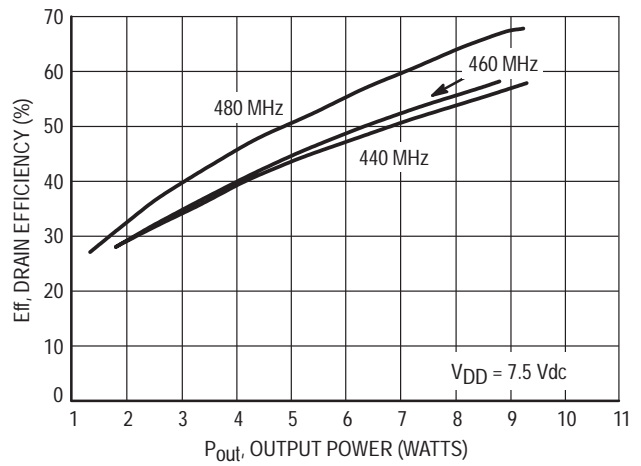

Figure 23. Drain Efficiency versus Output Power

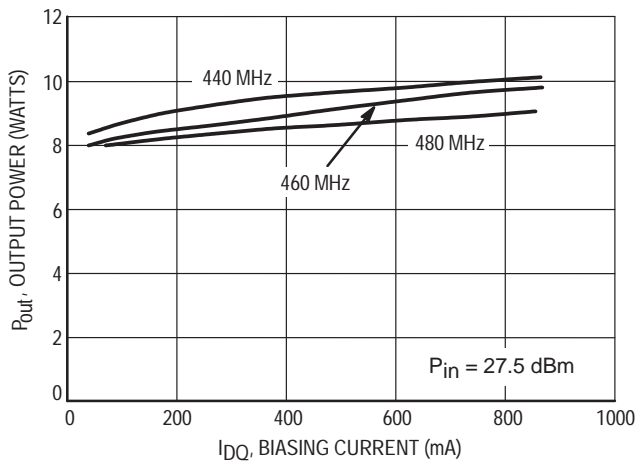

Figure 24. Output Power versus Biasing Current

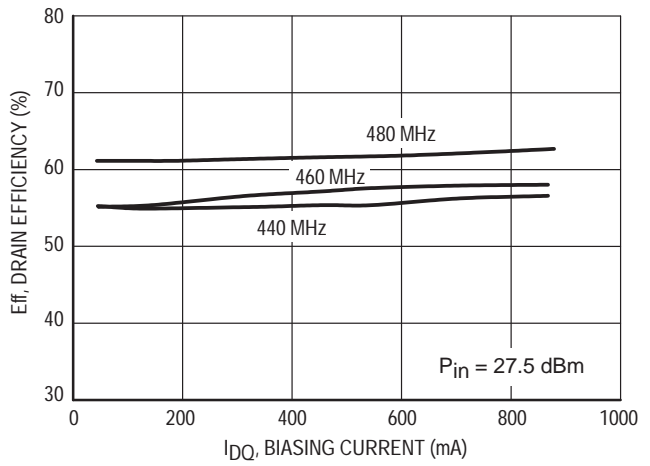

Figure 25. Drain Efficiency versus Biasing Current

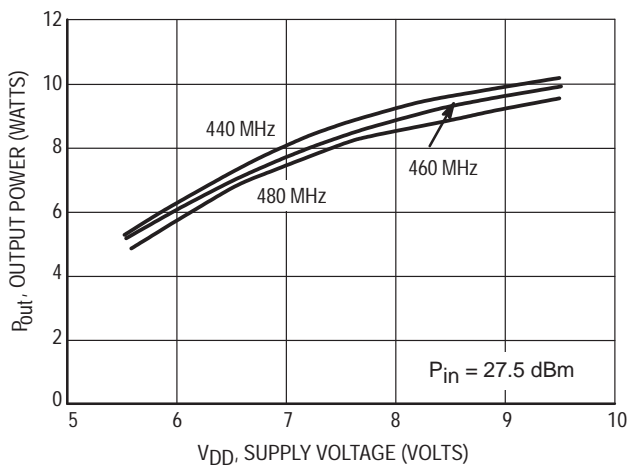

Figure 26. Output Power versus Supply Voltage

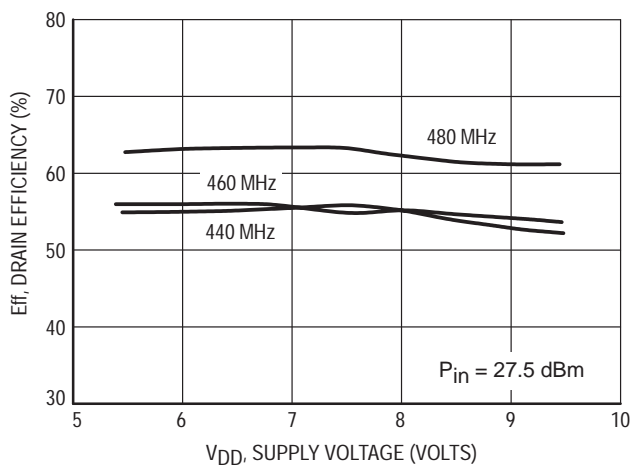
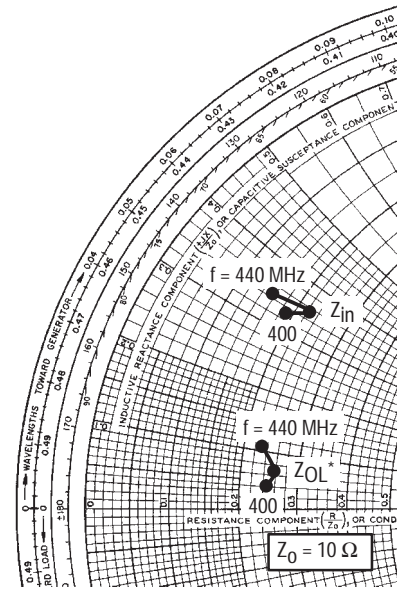
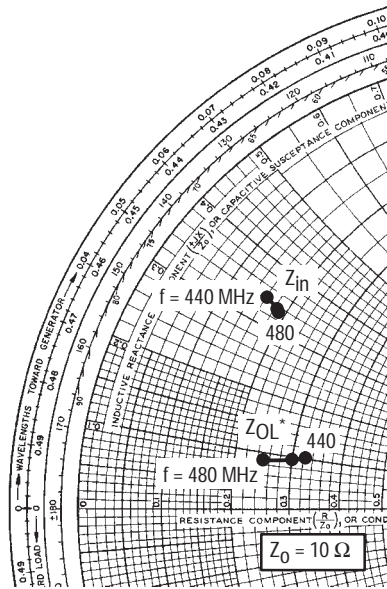
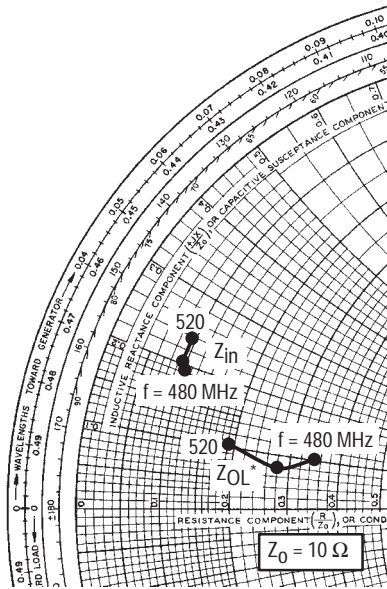

Figure 27. Drain Efficiency versus Supply Voltage



$V_{DD} = 7.5 \text{ V}$, $I_{DQ} = 150 \text{ mA}$, $P_{out} = 8 \text{ W}$

f MHz	Z_{in} Ω	Z_{OL}^* Ω
480	$1.06 + j1.82$	$3.51 + j0.99$
500	$0.97 + j2.01$	$2.82 + j0.75$
520	$0.975 + j2.37$	$1.87 + j1.03$

Z_{in} = Complex conjugate of source impedance.

Z_{OL}^* = Complex conjugate of the load impedance at given output power, voltage, frequency, and $\eta_D > 50\%$.

$V_{DD} = 7.5 \text{ V}$, $I_{DQ} = 150 \text{ mA}$, $P_{out} = 8 \text{ W}$

f MHz	Z_{in} Ω	Z_{OL}^* Ω
440	$1.62 + j3.41$	$3.25 + j0.98$
460	$1.85 + j3.35$	$3.05 + j0.93$
480	$1.91 + j3.31$	$2.54 + j0.84$

Z_{in} = Complex conjugate of source impedance.

Z_{OL}^* = Complex conjugate of the load impedance at given output power, voltage, frequency, and $\eta_D > 50\%$.

$V_{DD} = 7.5 \text{ V}$, $I_{DQ} = 150 \text{ mA}$, $P_{out} = 8 \text{ W}$

f MHz	Z_{in} Ω	Z_{OL}^* Ω
400	$1.96 + j3.32$	$2.52 + j0.39$
420	$2.31 + j3.56$	$2.61 + j0.64$
440	$1.60 + j3.45$	$2.37 + j1.04$

Z_{in} = Complex conjugate of source impedance.

Z_{OL}^* = Complex conjugate of the load impedance at given output power, voltage, frequency, and $\eta_D > 50\%$.

Note: Z_{OL}^* was chosen based on tradeoffs between gain, drain efficiency, and device stability.

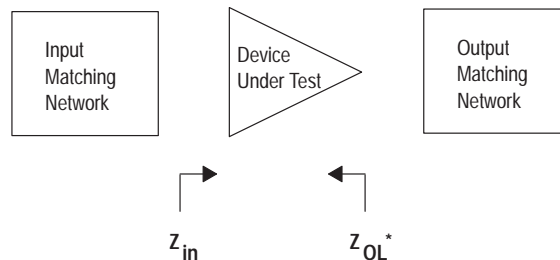

Figure 28. Series Equivalent Input and Output Impedance

Table 1. Common Source Scattering Parameters ($V_{DD} = 7.5$ Vdc)

$I_{DQ} = 150$ mA

f MHz	S ₁₁		S ₂₁		S ₁₂		S ₂₂	
	S ₁₁	φ	S ₂₁	φ	S ₁₂	φ	S ₂₂	φ
50	0.84	-152	17.66	97	0.016	0	0.77	-167
100	0.84	-164	8.86	85	0.016	5	0.78	-172
200	0.86	-170	4.17	72	0.015	-5	0.79	-173
300	0.88	-171	2.54	62	0.014	-8	0.80	-172
400	0.90	-172	1.72	55	0.013	-25	0.83	-172
500	0.92	-172	1.28	50	0.013	-10	0.84	-172
600	0.94	-173	0.98	46	0.014	-22	0.86	-171
700	0.95	-173	0.76	41	0.010	-30	0.86	-172
800	0.96	-174	0.61	38	0.011	-14	0.86	-171
900	0.96	-175	0.50	33	0.011	-31	0.85	-172
1000	0.97	-175	0.40	31	0.006	55	0.88	-171

$I_{DQ} = 800$ mA

f MHz	S ₁₁		S ₂₁		S ₁₂		S ₂₂	
	S ₁₁	φ	S ₂₁	φ	S ₁₂	φ	S ₂₂	φ
50	0.90	-165	20.42	94	0.018	1	0.76	-164
100	0.89	-172	10.20	87	0.015	-7	0.77	-170
200	0.90	-175	4.96	79	0.015	-12	0.77	-172
300	0.90	-176	3.17	73	0.017	-2	0.80	-171
400	0.91	-176	2.26	67	0.013	1	0.82	-172
500	0.92	-176	1.75	63	0.011	-6	0.83	-171
600	0.93	-176	1.39	59	0.012	-31	0.85	-171
700	0.94	-176	1.14	55	0.015	-34	0.88	-171
800	0.94	-176	0.93	51	0.008	-22	0.87	-171
900	0.95	-177	0.78	45	0.007	2	0.87	-172
1000	0.96	-177	0.65	43	0.008	-40	0.90	-170

$I_{DQ} = 1.5$ A

f MHz	S ₁₁		S ₂₁		S ₁₂		S ₂₂	
	S ₁₁	φ	S ₂₁	φ	S ₁₂	φ	S ₂₂	φ
50	0.92	-165	19.90	95	0.017	3	0.76	-164
100	0.90	-172	9.93	88	0.018	2	0.77	-170
200	0.91	-176	4.84	80	0.016	-4	0.77	-172
300	0.91	-176	3.10	74	0.014	-11	0.80	-172
400	0.92	-176	2.22	68	0.014	-14	0.81	-172
500	0.93	-176	1.73	64	0.016	-8	0.83	-171
600	0.94	-176	1.39	61	0.013	-24	0.85	-171
700	0.94	-176	1.12	56	0.013	-24	0.87	-171
800	0.95	-176	0.93	52	0.009	-12	0.87	-171
900	0.96	-177	0.78	46	0.008	10	0.87	-173
1000	0.97	-177	0.64	44	0.012	4	0.89	-169

APPLICATIONS INFORMATION

DESIGN CONSIDERATIONS

This device is a common-source, RF power, N-Channel enhancement mode, Lateral Metal-Oxide Semiconductor Field-Effect Transistor (MOSFET). Motorola Application Note AN211A, "FETs in Theory and Practice", is suggested reading for those not familiar with the construction and characteristics of FETs.

This surface mount packaged device was designed primarily for VHF and UHF portable power amplifier applications. Manufacturability is improved by utilizing the tape and reel capability for fully automated pick and placement of parts. However, care should be taken in the design process to insure proper heat sinking of the device.

The major advantages of Lateral RF power MOSFETs include high gain, simple bias systems, relative immunity from thermal runaway, and the ability to withstand severely mismatched loads without suffering damage.

MOSFET CAPACITANCES

The physical structure of a MOSFET results in capacitors between all three terminals. The metal oxide gate structure determines the capacitors from gate-to-drain (C_{gd}), and gate-to-source (C_{gs}). The PN junction formed during fabrication of the RF MOSFET results in a junction capacitance from drain-to-source (C_{ds}). These capacitances are characterized as input (C_{iss}), output (C_{oss}) and reverse transfer (C_{rss}) capacitances on data sheets. The relationships between the inter-terminal capacitances and those given on data sheets are shown below. The C_{iss} can be specified in two ways:

1. Drain shorted to source and positive voltage at the gate.
2. Positive voltage of the drain in respect to source and zero volts at the gate.

In the latter case, the numbers are lower. However, neither method represents the actual operating conditions in RF applications.

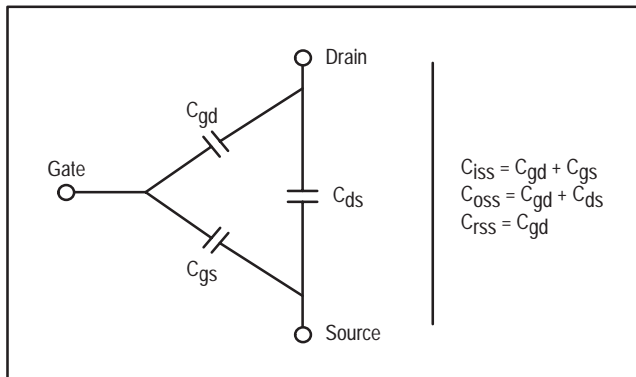

DRAIN CHARACTERISTICS

One critical figure of merit for a FET is its static resistance in the full-on condition. This on-resistance, $R_{DS(on)}$, occurs in the linear region of the output characteristic and is specified at a specific gate-source voltage and drain current. The drain-source voltage under these conditions is termed $V_{DS(on)}$. For MOSFETs, $V_{DS(on)}$ has a positive temperature

coefficient at high temperatures because it contributes to the power dissipation within the device.

BV_{DSS} values for this device are higher than normally required for typical applications. Measurement of BV_{DSS} is not recommended and may result in possible damage to the device.

GATE CHARACTERISTICS

The gate of the RF MOSFET is a polysilicon material, and is electrically isolated from the source by a layer of oxide. The DC input resistance is very high – on the order of $10^9 \Omega$ – resulting in a leakage current of a few nanoamperes.

Gate control is achieved by applying a positive voltage to the gate greater than the gate-to-source threshold voltage, $V_{GS(th)}$.

Gate Voltage Rating — Never exceed the gate voltage rating. Exceeding the rated V_{GS} can result in permanent damage to the oxide layer in the gate region.

Gate Termination — The gates of these devices are essentially capacitors. Circuits that leave the gate open-circuited or floating should be avoided. These conditions can result in turn-on of the devices due to voltage build-up on the input capacitor due to leakage currents or pickup.

Gate Protection — These devices do not have an internal monolithic zener diode from gate-to-source. If gate protection is required, an external zener diode is recommended. Using a resistor to keep the gate-to-source impedance low also helps dampen transients and serves another important function. Voltage transients on the drain can be coupled to the gate through the parasitic gate-drain capacitance. If the gate-to-source impedance and the rate of voltage change on the drain are both high, then the signal coupled to the gate may be large enough to exceed the gate-threshold voltage and turn the device on.

DC BIAS

Since this device is an enhancement mode FET, drain current flows only when the gate is at a higher potential than the source. RF power FETs operate optimally with a quiescent drain current (I_{DQ}), whose value is application dependent. This device was characterized at $I_{DQ} = 150 \text{ mA}$, which is the suggested value of bias current for typical applications. For special applications such as linear amplification, I_{DQ} may have to be selected to optimize the critical parameters.

The gate is a dc open circuit and draws no current. Therefore, the gate bias circuit may generally be just a simple resistive divider network. Some special applications may require a more elaborate bias system.

GAIN CONTROL

Power output of this device may be controlled to some degree with a low power dc control signal applied to the gate, thus facilitating applications such as manual gain control, ALC/AGC and modulation systems. This characteristic is very dependent on frequency and load line.

MOUNTING

The specified maximum thermal resistance of 2°C/W assumes a majority of the 0.065" x 0.180" source contact on the back side of the package is in good contact with an appropriate heat sink. As with all RF power devices, the goal of the thermal design should be to minimize the temperature at the back side of the package. Refer to Motorola Application Note AN4005/D, "Thermal Management and Mounting Method for the PLD-1.5 RF Power Surface Mount Package," and Engineering Bulletin EB209/D, "Mounting Method for RF Power Leadless Surface Mount Transistor" for additional information.

AMPLIFIER DESIGN

Impedance matching networks similar to those used with bipolar transistors are suitable for this device. For examples see Motorola Application Note AN721, "Impedance Matching Networks Applied to RF Power Transistors." Large-signal

impedances are provided, and will yield a good first pass approximation.

Since RF power MOSFETs are triode devices, they are not unilateral. This coupled with the very high gain of this device yields a device capable of self oscillation. Stability may be achieved by techniques such as drain loading, input shunt resistive loading, or output to input feedback. The RF test fixture implements a parallel resistor and capacitor in series with the gate, and has a load line selected for a higher efficiency, lower gain, and more stable operating region.

Two-port stability analysis with this device's S-parameters provides a useful tool for selection of loading or feedback circuitry to assure stable operation. See Motorola Application Note AN215A, "RF Small-Signal Design Using Two-Port Parameters" for a discussion of two port network theory and stability.

NOTES

NOTES

NOTES

PACKAGE DIMENSIONS

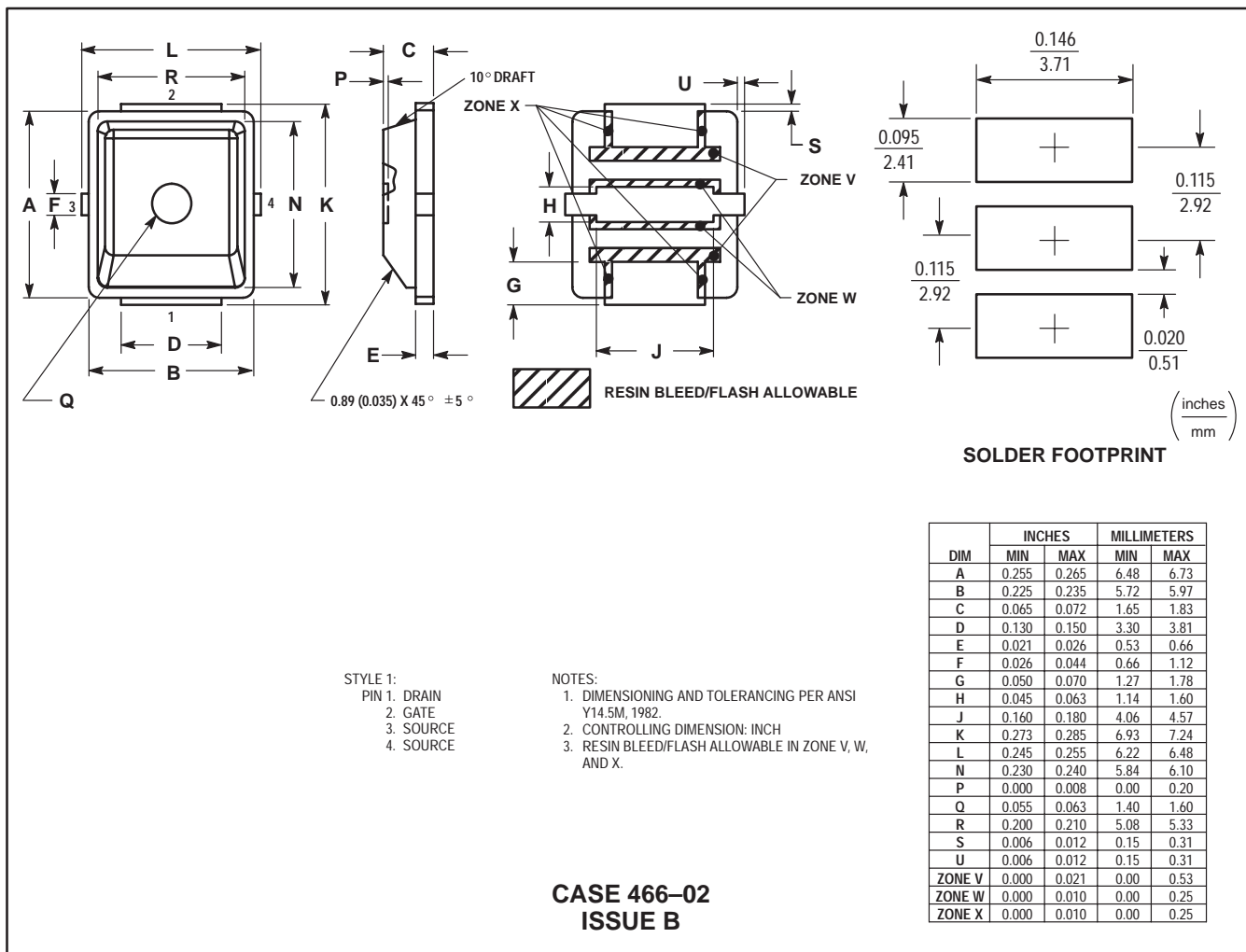

Motorola reserves the right to make changes without further notice to any products herein. Motorola makes no warranty, representation or guarantee regarding the suitability of its products for any particular purpose, nor does Motorola assume any liability arising out of the application or use of any product or circuit, and specifically disclaims any and all liability, including without limitation consequential or incidental damages. "Typical" parameters which may be provided in Motorola data sheets and/or specifications can and do vary in different applications and actual performance may vary over time. All operating parameters, including "Typicals" must be validated for each customer application by customer's technical experts. Motorola does not convey any license under its patent rights nor the rights of others. Motorola products are not designed, intended, or authorized for use as components in systems intended for surgical implant into the body, or other applications intended to support or sustain life, or for any other application in which the failure of the Motorola product could create a situation where personal injury or death may occur. Should Buyer purchase or use Motorola products for any such unintended or unauthorized application, Buyer shall indemnify and hold Motorola and its officers, employees, subsidiaries, affiliates, and distributors harmless against all claims, costs, damages, and expenses, and reasonable attorney fees arising out of, directly or indirectly, any claim of personal injury or death associated with such unintended or unauthorized use, even if such claim alleges that Motorola was negligent regarding the design or manufacture of the part. Motorola and are registered trademarks of Motorola, Inc. Motorola, Inc. is an Equal Opportunity/Affirmative Action Employer.

How to reach us:

USA/EUROPE/Locations Not Listed: Motorola Literature Distribution; P.O. Box 5405, Denver, Colorado 80217. 1-303-675-2140 or 1-800-441-2447

JAPAN: Motorola Japan Ltd.; SPS, Technical Information Center, 3-20-1, Minami-Azabu. Minato-ku, Tokyo 106-8573 Japan. 81-3-3440-3569

ASIA/PACIFIC: Motorola Semiconductors H.K. Ltd.; Silicon Harbour Centre, 2 Dai King Street, Tai Po Industrial Estate, Tai Po, N.T., Hong Kong. 852-26668334

Technical Information Center: 1-800-521-6274

HOME PAGE: <http://www.motorola.com/semiconductors/>

