

**GREEN MODE PWM CONTROLLER****AP3101****General Description**

The AP3101 is a green PWM controller operating in current mode. It is specially designed for off-line AC-DC adapter and battery charger applications where the needs for low standby power and better protection function are increasing.

The AP3101 features adjustable oscillator frequency in normal operation, which is done by an external resistor. It automatically switches to skip cycle mode when output power drops below a given level. The IC also features low start-up and operation current for its BiCMOS process.

The AP3101 provides comprehensive protection features including leading edge blanking, synchronized slope compensation, over-current, over-temperature and short circuit protection.

The AP3101 is available in 2 packages: SOIC-8 and DIP-8.

Features

- Green Current Mode PWM Controller
- Adjustable Skip Level
- Leading Edge Blanking (LEB)
- Cycle by Cycle Current Limit
- Built-in Short Circuit Protection
- Built-in Synchronized Slope Compensation
- Low Start-up/Operating Current: 30 μ A/3mA
- Adjustable Oscillator Frequency
- Totem Pole Output Including Soft Driving
- Under-Voltage Lockout (UVLO)
- Accurate Over-Temperature Protection with Hysteresis

Applications

- Off-line AC-DC Adapter
- Battery Charger Applications

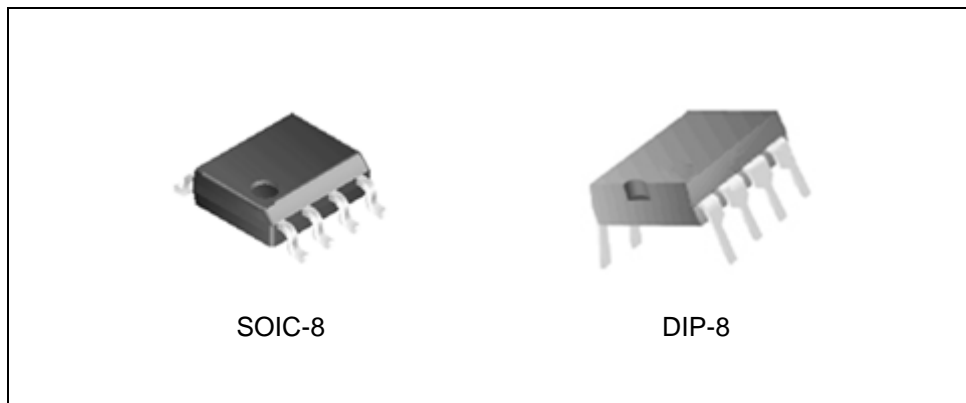


Figure 1. Package Types of AP3101



GREEN MODE PWM CONTROLLER **AP3101**

Pin Configuration

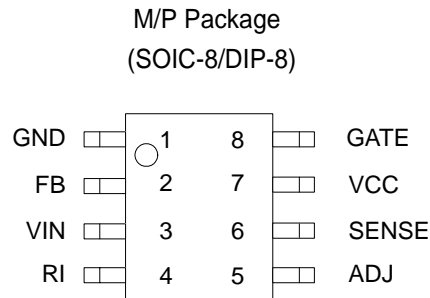


Figure 2. Pin Configuration of AP3101 (Top View)

Pin Description

Pin Number	Pin Name	Function
1	GND	Power ground
2	FB	Feedback
3	VIN	Start-up current in
4	RI	Reference setting
5	ADJ	Adjust the level of skip cycle
6	SENSE	Current sense
7	VCC	The positive supply of the control IC
8	GATE	Driver output



GREEN MODE PWM CONTROLLER

AP3101

Functional Block Diagram

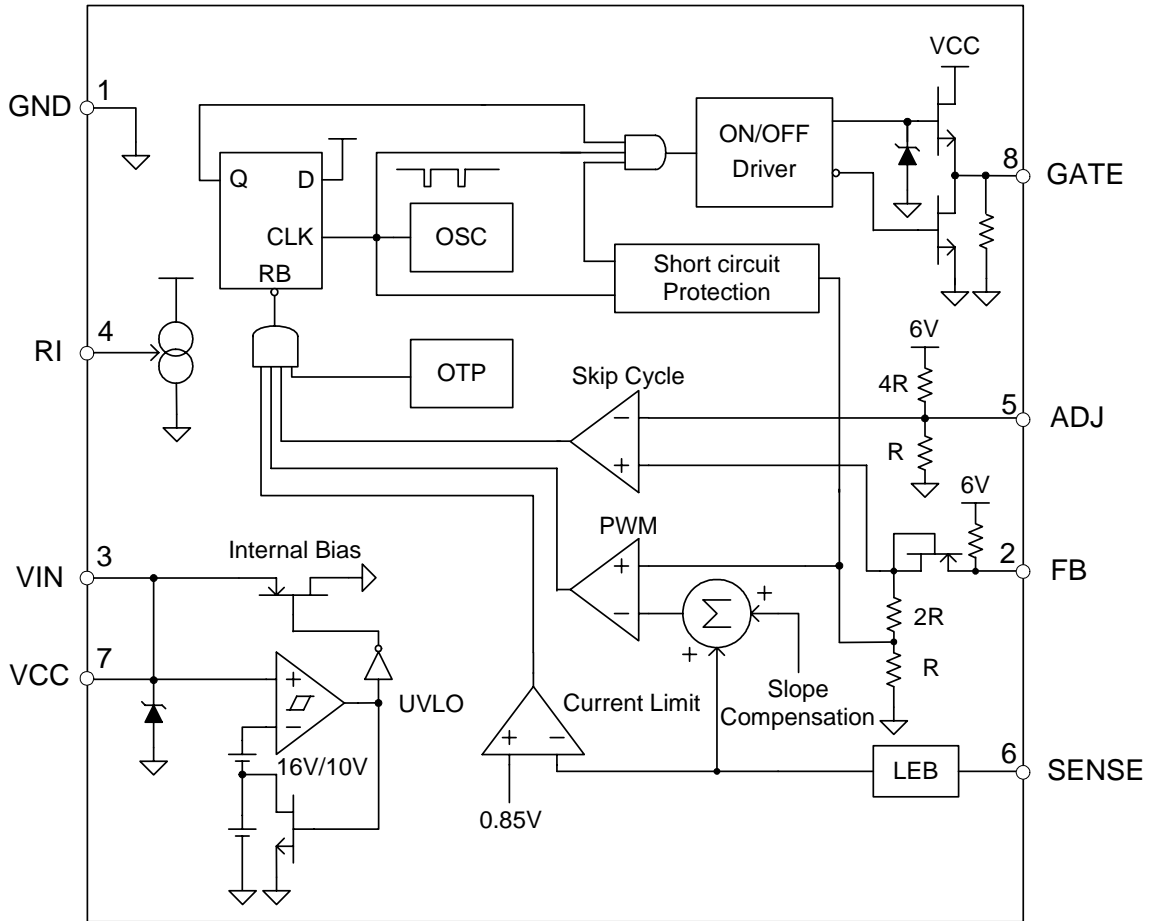
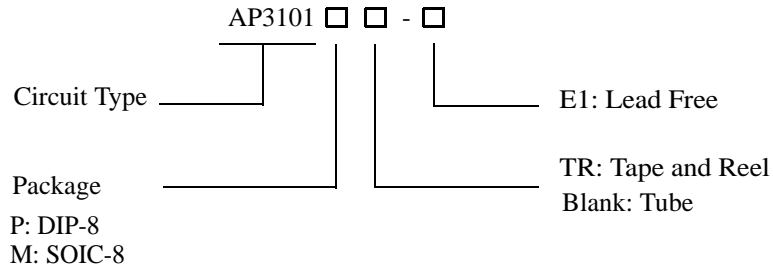


Figure 3. Functional Block Diagram of AP3101



GREEN MODE PWM CONTROLLER **AP3101**

Ordering Information



Package	Temperature Range	Part Number	Marking ID	Packing Type
DIP-8	-40 to 85°C	AP3101P-E1	AP3101P-E1	Tube
SOIC-8	-40 to 85°C	AP3101M-E1	3101M-E1	Tube
		AP3101MTR-E1	3101M-E1	Tape & Reel

BCD Semiconductor's Pb-free products, as designated with "E1" suffix in the part number, are RoHS compliant.

**GREEN MODE PWM CONTROLLER****AP3101****Absolute Maximum Ratings (Note 1)**

Parameter	Symbol	Value	Unit
Supply Voltage	V_{CC}	30	V
Gate Output Current	I_O	600	mA
Input Voltage to FB		-0.3 to 7	V
Input Voltage to SENSE		-0.3 to 7	V
Input Voltage to RI		-0.3 to 7	V
Input Voltage to ADJ		-0.3 to 7	V
Operating Junction Temperature		150	°C
Storage Temperature Range	T_{STG}	-65 to 150	°C
ESD (Human Body Model)		4	kV
ESD (Machine Model)		400	V
Power Dissipation at $T_A < 25^\circ\text{C}$	DIP-8 Package	1350	mW
	SOIC-8 Package	550	
Thermal Resistance (Junction to Ambient)	DIP-8 Package	83	°C/W
	SOIC-8 Package	186	

Note 1: Stresses greater than those listed under "Absolute Maximum Ratings" may cause permanent damage to the device. These are stress ratings only, and functional operation of the device at these or any other conditions beyond those indicated under "Recommended Operating Conditions" is not implied. Exposure to "Absolute Maximum Ratings" for extended periods may affect device reliability.

Recommended Operating Conditions

Parameter	Symbol	Min	Max	Unit
Operating Ambient Temperature	T_A	-40	85	°C
Supply Voltage	V_{CC}		20	V



GREEN MODE PWM CONTROLLER

AP3101

Electrical Characteristics

($V_{CC}=15V$, $T_A=25^{\circ}C$, unless otherwise specified.)

Parameter	Symbol	Conditions	Min	Typ	Max	Unit
UNDER-VOLTAGE LOCKOUT SECTION						
Start-up Voltage	V_{THON}		15	16	17	V
Minimum Operating Voltage	V_{THOFF}		9	10	11	V
TOTAL STANDBY CURRENT SECTION						
Start-up Current		$V_{CC}=14.8V$		30	45	μA
Operating Current	I_{CC}	$V_{FB}=V_{SENSE}=0V, C_L=1nF$		3	4	mA
PWM SECTION						
Maximum Duty Cycle	D_{MAX}		70	80	90	%
Minimum Duty Cycle	D_{MIN}				0	%
OSCILLATOR SECTION						
Oscillation Frequency	f_{OSC}	$R_I=26k\Omega$	60	65	70	kHz
Frequency Change with Voltage		$V_{CC}=10$ to $20V$			2	%
Temperature Stability		$T_A=-40^{\circ}C$ to $85^{\circ}C$			5	%
FEEDBACK INPUT SECTION						
The Ratio of Input Voltage to Current Sense Voltage			2.5	3	3.5	V/V
Input Impedance			3	4.5	6	$k\Omega$
Source Current					-2	mA
Input Voltage for Zero Duty					1.2	V
CURRENT SENSE SECTION						
Threshold Voltage	V_{TH}		0.8	0.85	0.9	V
Delay to Output				150	200	ns
The Delay Time of Short Circuit Protection		$R_I=26k\Omega$		23		ms
OUTPUT SECTION						
Low Level Voltage	V_{OL}	$I_O=200mA, V_{CC}=12V$			1.5	V
High Level Voltage	V_{OH}	$I_O=50mA, V_{CC}=12V$	8			V
Rise Time	t_R	$V_{CC}=13V, C_L=1nF$	150	250	350	ns
Fall Time	t_F	$V_{CC}=13V, C_L=1nF$	30	50	90	ns

**GREEN MODE PWM CONTROLLER****AP3101****Electrical Characteristics (Continued)**

Parameter	Symbol	Conditions	Min	Typ	Max	Unit
SKIP CYCLE SECTION						
Default Skip Level	V_{SKIP}			1.2		V
Leading Edge Blank			200	270	350	ns
OVER-TEMPERATURE PROTECTION SECTION						
Shutdown Temperature				155		°C
Temperature Hysteresis				25		°C

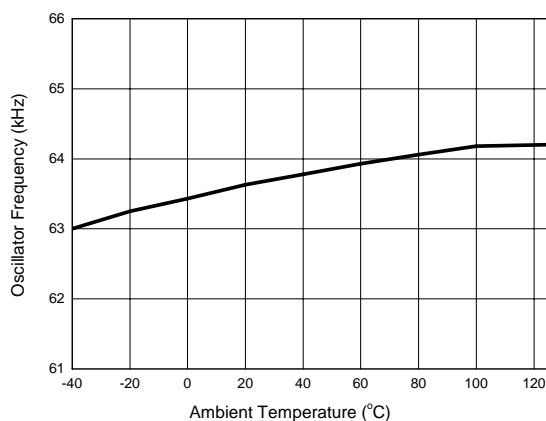
Typical Performance Characteristics

Figure 4. Oscillator Frequency vs. Ambient Temperature

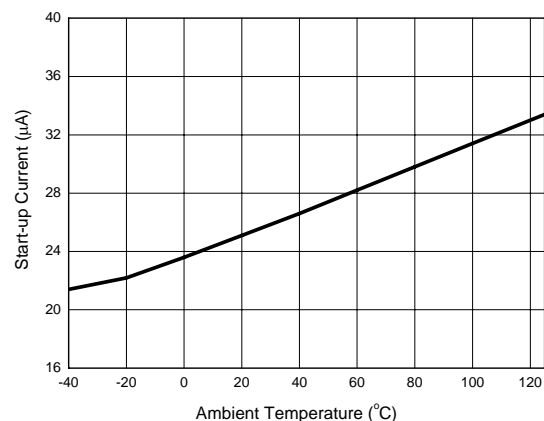


Figure 5. Start-up Current vs. Ambient Temperature



GREEN MODE PWM CONTROLLER

AP3101

Typical Performance Characteristics (Continued)

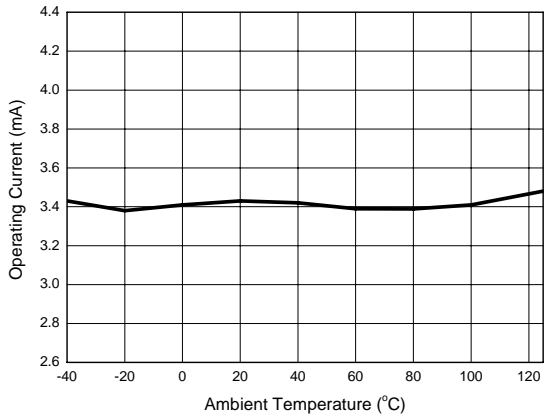


Figure 6. Operating Current vs. Ambient Temperature

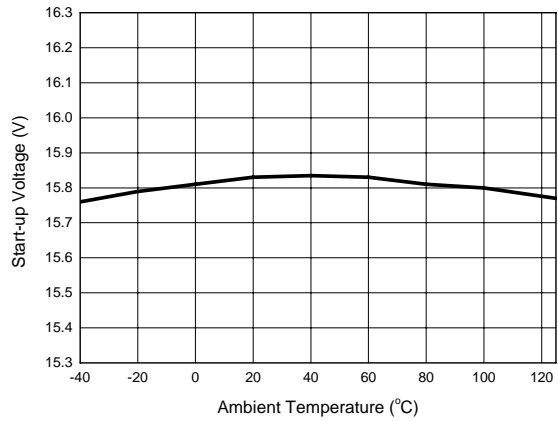


Figure 7. Start-up Voltage vs. Ambient Temperature

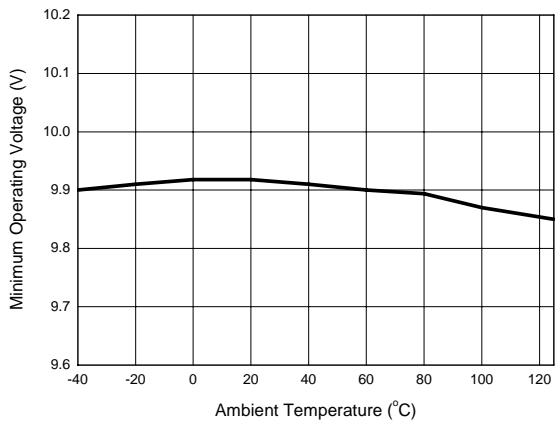


Figure 8. Minimum Operating Voltage vs. Ambient Temperature

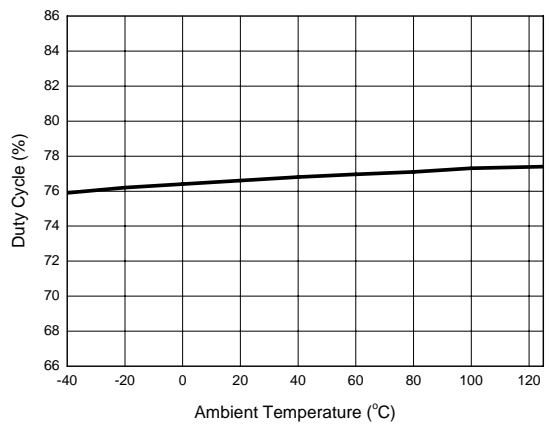


Figure 9. Duty Cycle vs. Ambient Temperature

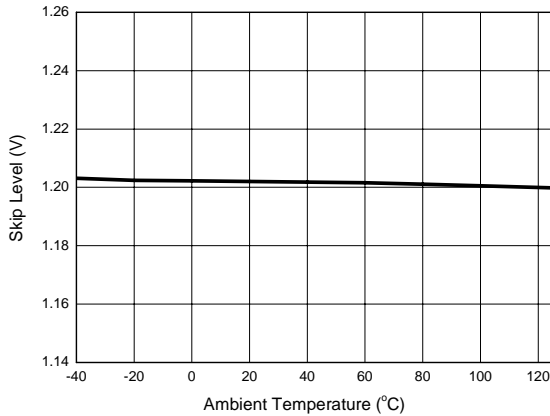
**GREEN MODE PWM CONTROLLER****AP3101****Typical Performance Characteristics (Continued)**

Figure 10. Skip Level vs. Ambient Temperature

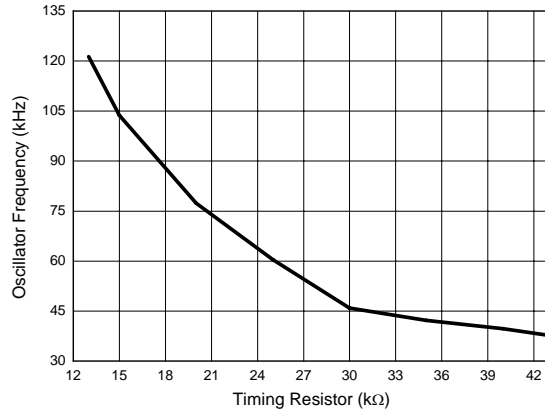


Figure 11. Oscillator Frequency vs. Timing Resistor

Operation Description

The AP3101 is specially designed for off-line AC-DC adapter and battery charger applications. It offers the designer a cost effective solution with minimal external components.

Oscillator

The oscillation frequency is programmed by the value of resistor R1 connected from pin RI to ground. The resistor will make a constant current source to determine the oscillation frequency by charging and discharging an internal capacitor. The oscillation frequency can be expressed as:

$$f \approx \frac{1690}{R1(k\Omega)} (kHz)$$

The recommended oscillation frequency is 50 to 100 kHz.

Start-up Current and Operating Current

The typical start-up current is only 30μA. With such a low start-up current, the start-up resistor may have a

very high resistance value even in 85V line voltage; however, higher resistance will cause longer start-up time. So we must select a proper start-up resistor and a proper V_{CC} hold-up capacitor. Operating current is lowered to 3mA. It can reduce the requirement of V_{CC} hold-up capacitor value and the power loss in AP3101.

Under-Voltage Lockout (UVLO)

An UVLO comparator is included in AP3101 to detect the voltage on the VCC pin. It ensures AP3101 to draw adequate energy from hold-up capacitor during power on. The turn-on threshold is 16V and the turn-off threshold is 10V.

Current Sense Comparator and PWM Latch

AP3101 operates as a current mode controller, the output switch conduction is initiated by every oscillator cycle and terminated when the peak inductor current reaches the threshold level established by the FB pin. The inductor current signal is converted to a voltage signal by inserting a referenced sense resistor RS

**GREEN MODE PWM CONTROLLER****AP3101****Operation Description (Continued)**

in series with the source of the MOSFET. The peak inductor current under normal operating conditions is controlled by the voltage at FB pin:

$$I_{pk} = (V_{FB} - 0.9) / 3R_s$$

Abnormal operating conditions occur when the power supply output is overloaded or the output voltage sensing is lost. Under these conditions, the current sense comparator threshold will be internally clamped to 0.85V. Therefore the maximum peak switch current is:

$$I_{PK(max)} = 0.85 / R_s$$

Leading Edge Blanking

A narrow spike on the leading edge of the current waveform can usually be observed when the power MOSFET is turned on. A 270 ns leading-edge blank is built-in to prevent the false-triggering caused by the turn-on spike; so the RC filter on the current sense input can be removed. During this period, the current limit comparator is disabled and the gate driver can not be switched off.

Built-in Slope Compensation

It is well known that a continuous current mode SMPS may become unstable when the duty cycle exceeds 50%. The built-in slope compensation can improve the stability, so there is no need for design engineer to spend much time on that.

Short Circuit Protection

Built-in short circuit protection can protect a SMPS from being damaged when short circuit of output or over load conditions happen. The feedback voltage will keep its value above its upper limit of 4.2V as long as short circuit exists, and then gate driver will be turned off after fixed delay time of 23 ms. When V_{CC} of AP3101 dropped under the minimum operating voltage, the device will be turned off and the system will try to restart. The SMPS will not recover its normal operation until the short circuit or over load is removed.

Green Mode Operation

ADJ pin is the non-inverting input of skip cycle comparator. The voltage at FB pin minus 0.9V is compared with the voltage at ADJ pin. If the voltage at ADJ pin is larger, AP3101 will start to blank its output pulse. In normal operation, AP3101 works at fixed switching frequency, and V_{FB} is in high level. When load power becomes lighter, the V_{FB} will decrease. When V_{FB} drops to the threshold, AP3101 will enter the skip cycle mode and operate intermittently. The threshold is adjustable by changing the value of the resistor connected from pin ADJ to the ground.



BCD Semiconductor Manufacturing Limited

<http://www.bcdsemi.com>

IMPORTANT NOTICE

BCD Semiconductor Manufacturing Limited reserves the right to make changes without further notice to any products or specifications herein. BCD Semiconductor Manufacturing Limited does not assume any responsibility for use of any its products for any particular purpose, nor does BCD Semiconductor Manufacturing Limited assume any liability arising out of the application or use of any its products or circuits. BCD Semiconductor Manufacturing Limited does not convey any license under its patent rights or other rights nor the rights of others.

MAIN SITE

BCD Semiconductor Manufacturing Limited

- Wafer Fab

Shanghai SIM-BCD Semiconductor Manufacturing Limited

800, Yi Shan Road, Shanghai 200233, China
Tel: +86-21-6485 1491, Fax: +86-21-5450 0008

BCD Semiconductor Manufacturing Limited

- IC Design Group

Advanced Analog Circuits (Shanghai) Corporation

8F Zone B, 900, Yi Shan Road, Shanghai 200233, China
Tel: +86-21-6495 9539, Fax: +86-21-6485 9673

REGIONAL SALES OFFICE

Shenzhen Office

Shanghai SIM-BCD Semiconductor Manufacturing Co., Ltd. Shenzhen Office

Advanced Analog Circuits (Shanghai) Corporation Shenzhen Office
Room E, 5F, Noble Center, No.1006, 3rd Fuzhong Road, Futian District, Shenzhen 518026, China
Tel: +86-755-8826 7951
Fax: +86-755-8826 7865

Taiwan Office

BCD Semiconductor (Taiwan) Company Limited

4F, 298-1, Rui Guang Road, Nei-Hu District, Taipei, Taiwan
Tel: +886-2-2656 2808
Fax: +886-2-2656 2806

USA Office

BCD Semiconductor Corporation

30920 Huntwood Ave. Hayward, CA 94544, U.S.A
Tel: +1-510-324-2988
Fax: +1-510-324-2788