

HiPerFAST™ IGBT

IXGH 60N60B2
IXGT 60N60B2

V_{CES} = 600 V
 I_{C25} = 75 A
 $V_{CE(sat)}$ < 1.8 V
 $t_{fi typ}$ = 100 ns

Optimized for 10-25 kHz hard switching and up to 100 KHz resonant switching

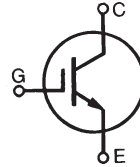

Symbol	Test Conditions	Maximum Ratings	
V_{CES}	$T_J = 25^\circ\text{C}$ to 150°C	600	V
V_{CGR}	$T_J = 25^\circ\text{C}$ to 150°C ; $R_{GE} = 1\ \text{M}\Omega$	600	V
V_{GES}	Continuous	± 20	V
V_{GEM}	Transient	± 30	V
I_{C25}	$T_C = 25^\circ\text{C}$ (limited by leads)	75	A
I_{C110}	$T_C = 110^\circ\text{C}$	60	A
I_{CM}	$T_C = 25^\circ\text{C}$, 1 ms	300	A
SSOA (RBSOA)	$V_{GE} = 15\ \text{V}$, $T_{VJ} = 125^\circ\text{C}$, $R_G = 10\ \Omega$ Clamped inductive load @ $\leq 600\ \text{V}$	$I_{CM} = 150$	A
P_C	$T_C = 25^\circ\text{C}$	500	W
T_J		-55 ... +150	$^\circ\text{C}$
T_{JM}		150	$^\circ\text{C}$
T_{stg}		-55 ... +150	$^\circ\text{C}$
Maximum lead temperature for soldering 1.6 mm (0.062 in.) from case for 10 s		300	$^\circ\text{C}$
M_d	Mounting torque (M3)	1.13/10 Nm/lb.in.	
Weight	TO-247 AD	6	g
	TO-268 SMD	4	g

TO-268
(IXGT)

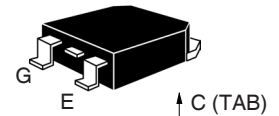

TO-247 AD
(IXGH)

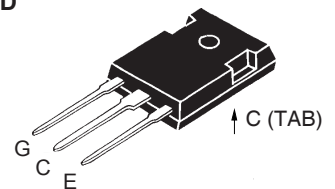

G = Gate, C = Collector,
E = Emitter, TAB = Collector

Features

- Medium frequency IGBT
- Square RBSOA
- High current handling capability
- MOS Gate turn-on - drive simplicity

Applications

- PFC circuits
- Uninterruptible power supplies (UPS)
- Switched-mode and resonant-mode power supplies
- AC motor speed control
- DC servo and robot drives
- DC choppers

Symbol	Test Conditions	Characteristic Values ($T_J = 25^\circ\text{C}$, unless otherwise specified)		
		min.	typ.	max.
$V_{GE(th)}$	$I_C = 250\ \mu\text{A}$, $V_{CE} = V_{GE}$	3.0		5.0 V
I_{CES}	$V_{CE} = V_{CES}$ $V_{GE} = 0\ \text{V}$			50 μA 1 mA
I_{GES}	$V_{CE} = 0\ \text{V}$, $V_{GE} = \pm 20\ \text{V}$			$\pm 100\ \text{nA}$
$V_{CE(sat)}$	$I_C = 50\ \text{A}$, $V_{GE} = 15\ \text{V}$ Note 1.			1.8 V

Symbol	Test Conditions	Characteristic Values ($T_J = 25^\circ\text{C}$, unless otherwise specified)			
		Min.	Typ.	Max.	
g_{fs}	$I_C = 50\text{ A}$; $V_{CE} = 10\text{ V}$, Note 1	40	58	S	
C_{ies} C_{oes} C_{res}	$V_{CE} = 25\text{ V}$, $V_{GE} = 0\text{ V}$, $f = 1\text{ MHz}$		3900	pF	
			290	pF	
			100	pF	
Q_g Q_{ge} Q_{gc}	$I_C = 50\text{ A}$, $V_{GE} = 15\text{ V}$, $V_{CE} = 0.5 V_{CES}$		170	nC	
			25	nC	
			57	nC	
$t_{d(on)}$ t_{ri} $t_{d(off)}$ t_{fi} E_{off}	Inductive load, $T_J = 25^\circ\text{C}$ $I_C = 50\text{ A}$, $V_{GE} = 15\text{ V}$ $V_{CE} = 400\text{ V}$, $R_G = 3.3\ \Omega$ Note 1		28	ns	
			30	ns	
			160	270	ns
			100	170	ns
			1.0	2.5	mJ
$t_{d(on)}$ t_{ri} E_{on} $t_{d(off)}$ t_{fi} E_{off}	Inductive load, $T_J = 125^\circ\text{C}$ $I_C = 50\text{ A}$, $V_{GE} = 15\text{ V}$ $V_{CE} = 400\text{ V}$, $R_G = 3.3\ \Omega$ Note 1		28	ns	
			36	ns	
			0.6	mJ	
			310	ns	
			240	ns	
			2.8	mJ	
R_{thJC} R_{thCK}		0.15	0.25	KW KW	

Notes:

1. Pulse test, $t < 300\mu\text{s}$ wide, duty cycle $< 2\%$.

Min. Recommended Footprint (Dimensions in inches and mm)

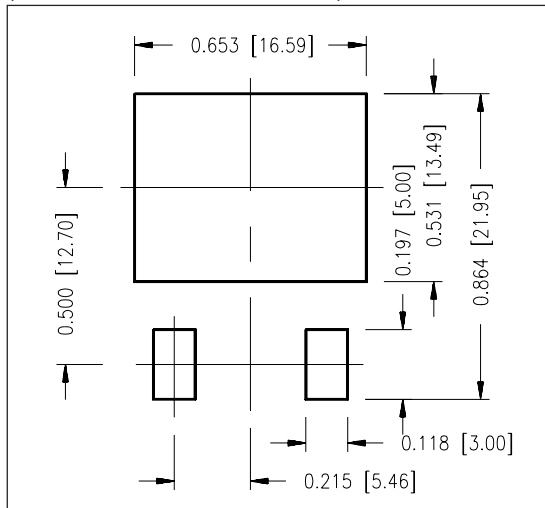

TO-247 AD Outline

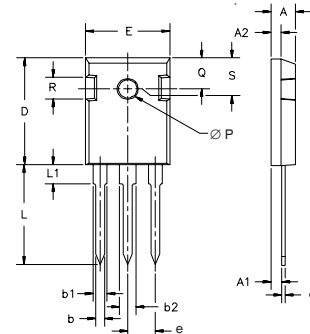

Dim.	Millimeter		Inches	
	Min.	Max.	Min.	Max.
A	4.7	5.3	.185	.209
A ₁	2.2	2.54	.087	.102
A ₂	2.2	2.6	.059	.098
b	1.0	1.4	.040	.055
b ₁	1.65	2.13	.065	.084
b ₂	2.87	3.12	.113	.123
C	.4	.8	.016	.031
D	20.80	21.46	.819	.845
E	15.75	16.26	.610	.640
e	5.20	5.72	0.205	0.225
L	19.81	20.32	.780	.800
L ₁		4.50		.177
ØP	3.55	3.65	.140	.144
Q	5.89	6.40	0.232	0.252
R	4.32	5.49	.170	.216
S	6.15	BSC	.242	BSC

TO-268 Outline

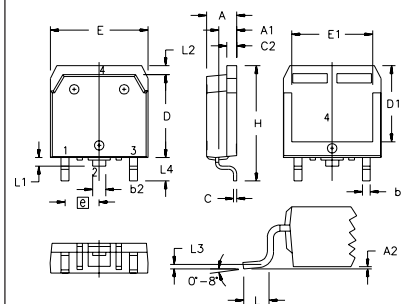

SYM	INCHES		MILLIMETERS	
	MIN	MAX	MIN	MAX
A	.193	.201	4.90	5.10
A ₁	.106	.114	2.70	2.90
A ₂	.001	.010	0.02	0.25
b	.045	.057	1.15	1.45
b ₂	.075	.083	1.90	2.10
C	.016	.026	0.40	0.65
C ₂	.057	.063	1.45	1.60
D	.543	.551	13.80	14.00
D ₁	.488	.500	12.40	12.70
E	.624	.632	15.85	16.05
E ₁	.524	.535	13.30	13.60
e	.215 BSC		5.45 BSC	
H	.736	.752	18.70	19.10
L	.094	.106	2.40	2.70
L ₁	.047	.055	1.20	1.40
L ₂	.039	.045	1.00	1.15
L ₃	.010 BSC		0.25 BSC	
L ₄	.150	.161	3.80	4.10

IXYS reserves the right to change limits, test conditions, and dimensions.

Fig. 1. Output Characteristics
@ 25 Deg. C

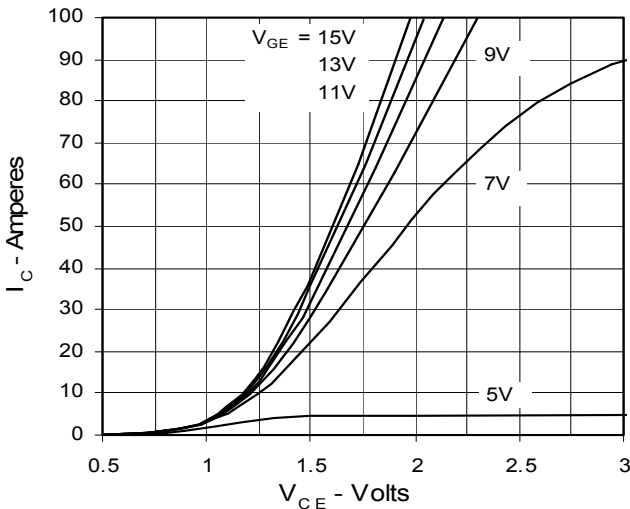

Fig. 2. Extended Output Characteristics
@ 25 deg. C

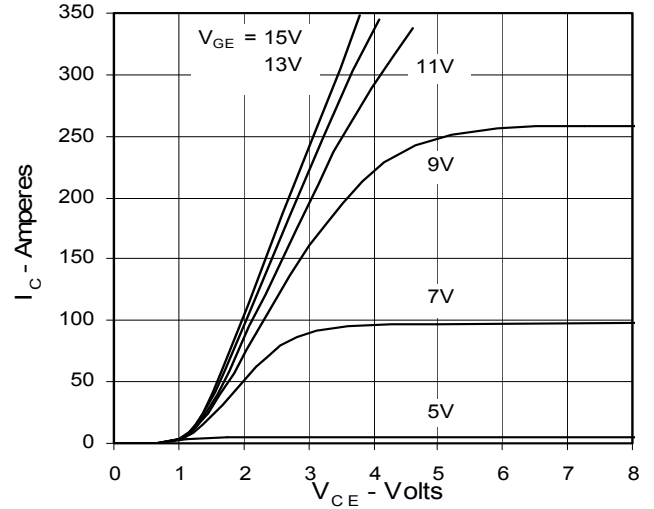

Fig. 3. Output Characteristics
@ 125 Deg. C

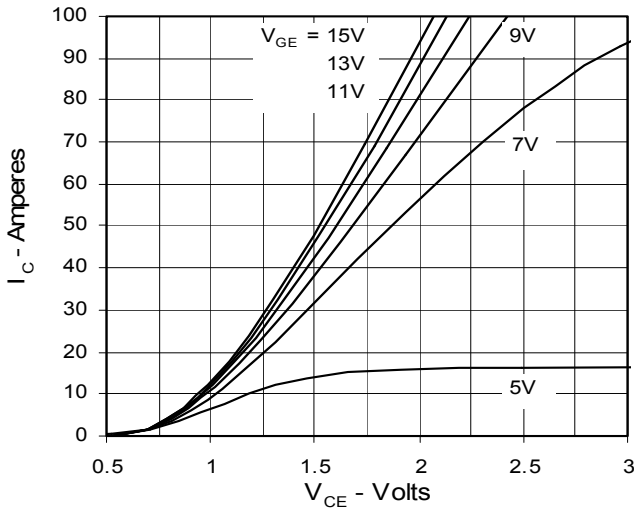

Fig. 4. Dependence of $V_{CE(sat)}$ on Temperature

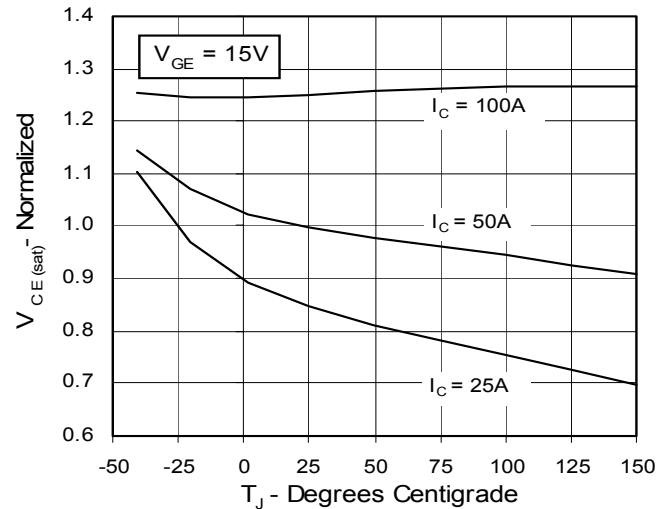

Fig. 5. Collector-to-Emitter Voltage vs. Gate-to-Emitter voltage

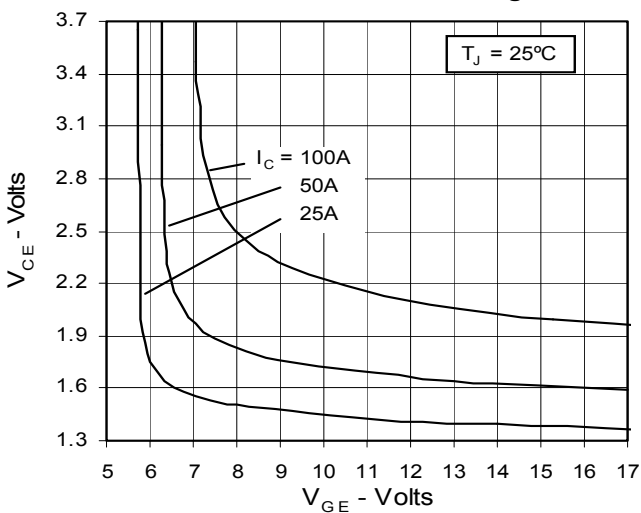

Fig. 6. Input Admittance

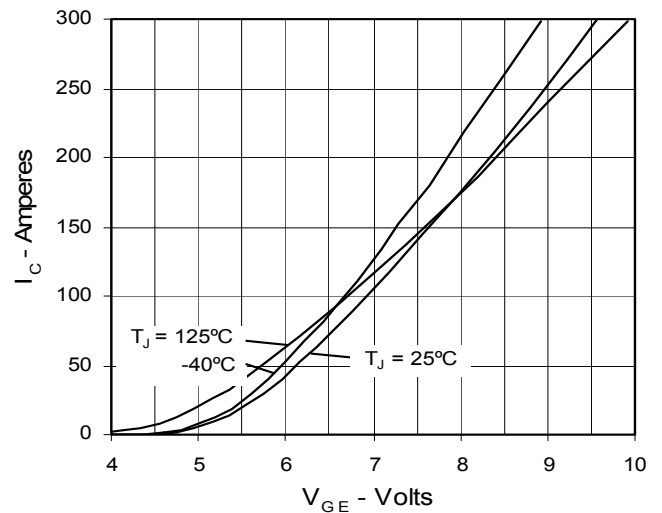

Fig. 7. Transconductance

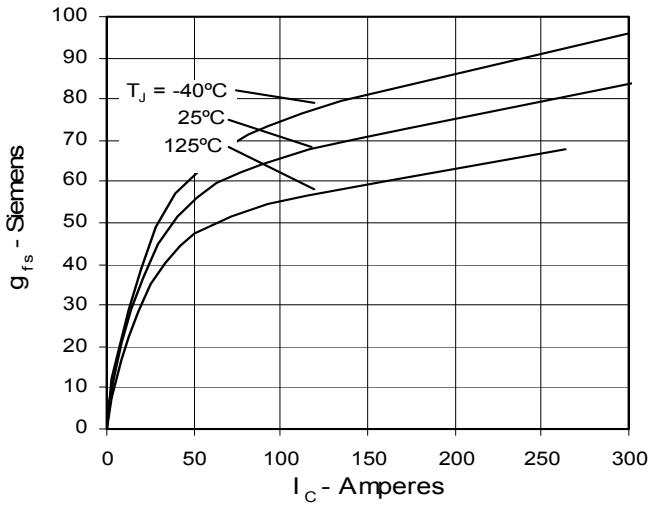

Fig. 8. Dependence of Turn-Off Energy on R_G

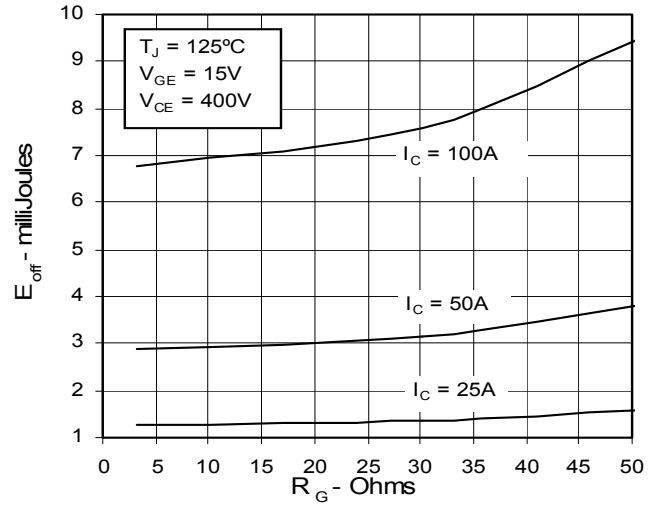

Fig. 9. Dependence of Turn-Off Energy on I_c

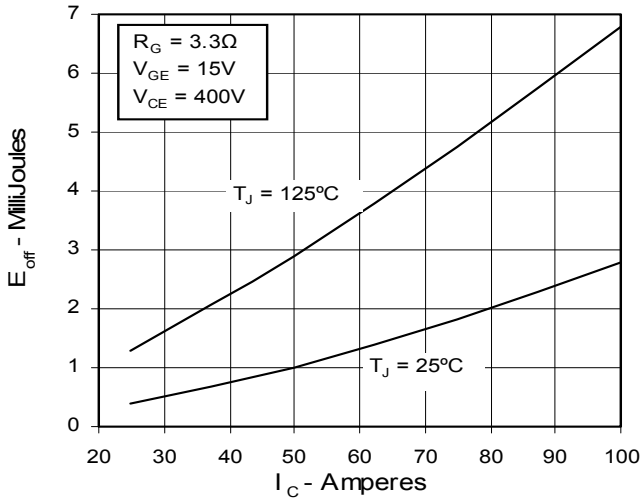

Fig. 10. Dependence of Turn-Off Energy on Temperature

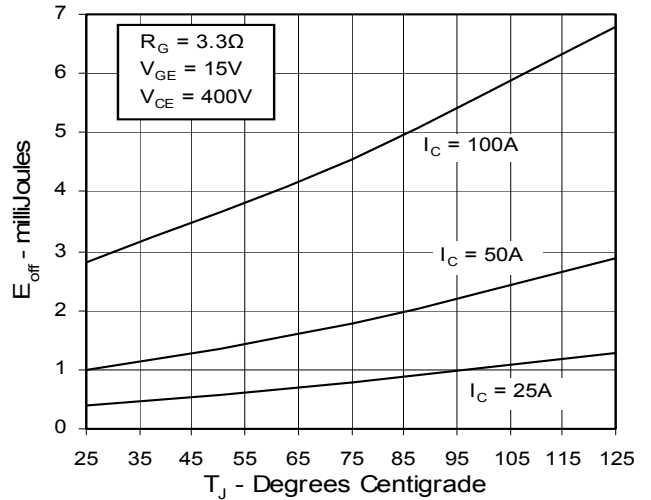

Fig. 11. Dependence of Turn-Off Switching Time on R_G

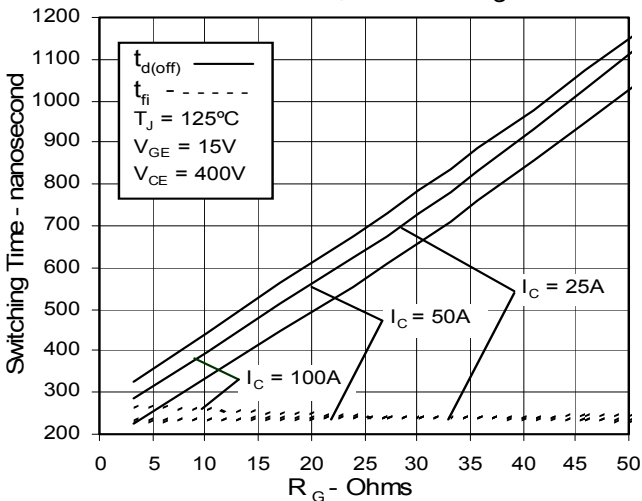

Fig. 12. Dependence of Turn-Off Switching Time on I_c

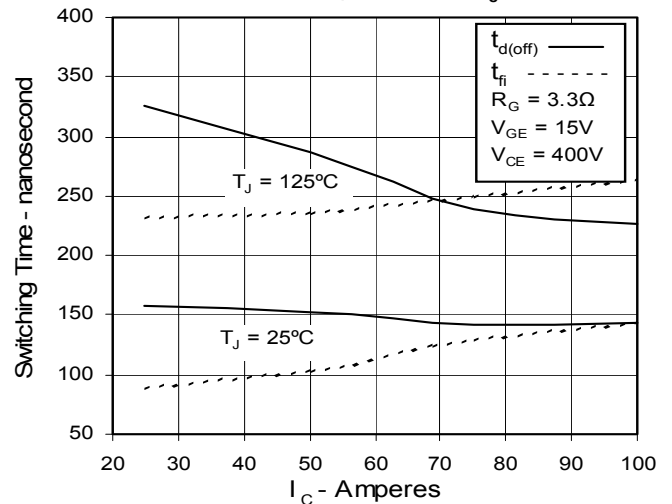

Fig. 13. Dependence of Turn-Off Switching Time on Temperature

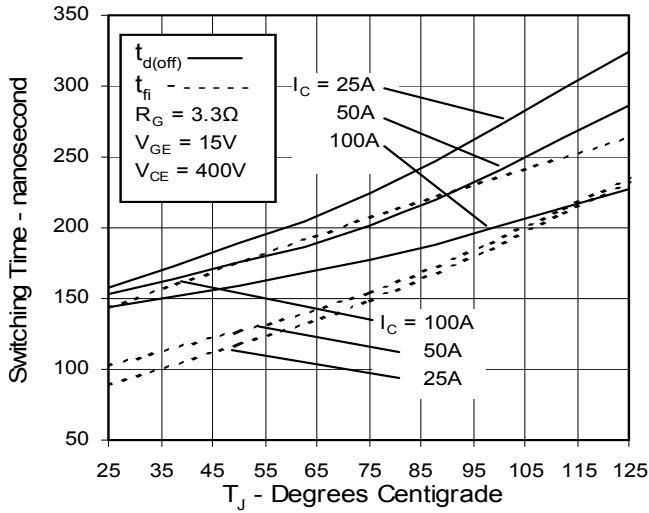

Fig. 14. Gate Charge

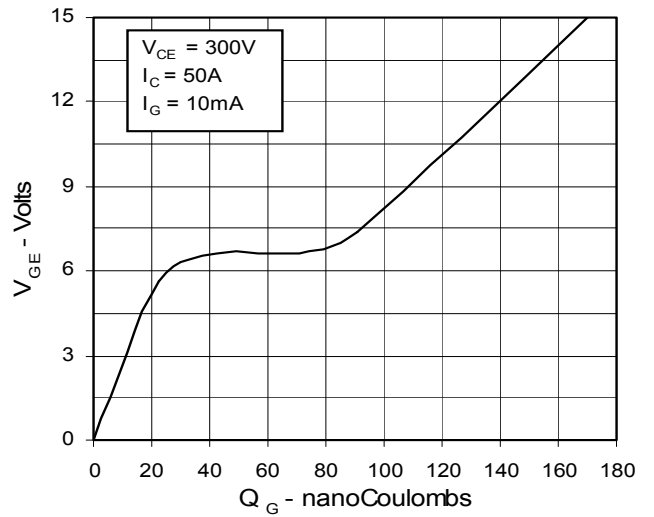

Fig. 15. Capacitance

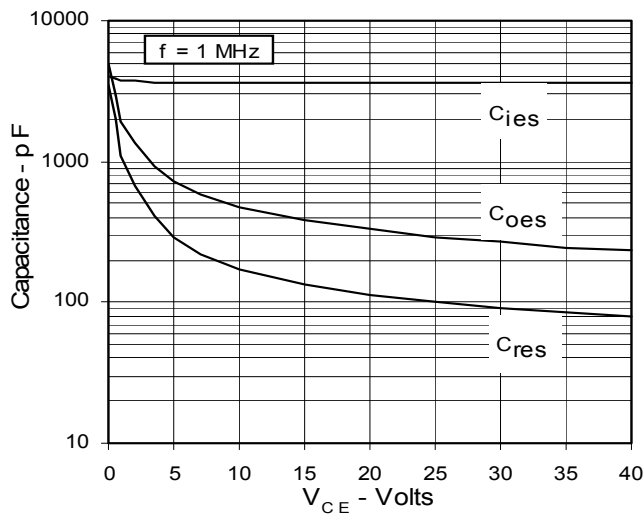

Fig. 16. Maximum Transient Thermal Resistance

