

**N - CHANNEL ENHANCEMENT MODE  
POWER MOS TRANSISTOR**

TYPE	V <sub>DSS</sub>	R <sub>DS(on)</sub>	I <sub>D</sub>
STP3N50XI	500 V	< 4 Ω	1.7 A

- TYPICAL R<sub>DS(on)</sub> = 2.5 Ω
- AVALANCHE RUGGED TECHNOLOGY
- 100% AVALANCHE TESTED
- REPETITIVE AVALANCHE DATA AT 100°C
- APPLICATION ORIENTED CHARACTERIZATION

**APPLICATIONS**

- HIGH CURRENT, HIGH SPEED SWITCHING
- SWITCH MODE POWER SUPPLIES (SMPS)
- CHOPPER REGULATORS, CONVERTERS, MOTOR CONTROL, LIGHTING FOR INDUSTRIAL AND CONSUMER ENVIRONMENT

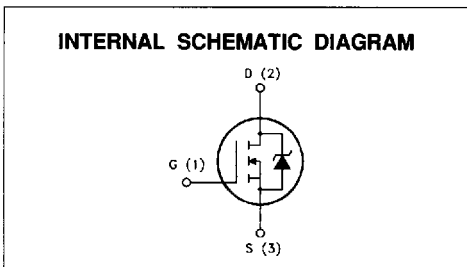
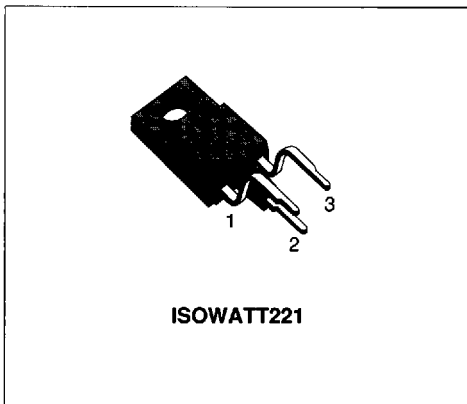

**ABSOLUTE MAXIMUM RATINGS**

Symbol	Parameter	Value	Unit
V <sub>DS</sub>	Drain-source Voltage (V <sub>GS</sub> = 0)	500	V
V <sub>DGR</sub>	Drain- gate Voltage (R <sub>GS</sub> = 20 kΩ)	500	V
V <sub>GS</sub>	Gate-source Voltage	± 20	V
I <sub>D</sub>	Drain Current (continuous) at T <sub>c</sub> = 25 °C	1.7	A
I <sub>D</sub>	Drain Current (continuous) at T <sub>c</sub> = 100 °C	1.1	A
I <sub>DM</sub> (*)	Drain Current (pulsed)	6.8	A
P <sub>tot</sub>	Total Dissipation at T <sub>c</sub> = 25 °C	25	W
	Derating Factor	0.2	W/°C
V <sub>ISO</sub>	Insulation Withstand Voltage (DC)	4000	V
T <sub>stg</sub>	Storage Temperature	-65 to 150	°C
T <sub>J</sub>	Max. Operating Junction Temperature	150	°C

(\*) Pulse width limited by safe operating area

## THERMAL DATA

$R_{thj-case}$	Thermal Resistance Junction-case	Max	5	$^{\circ}C/W$
$R_{thj-amb}$	Thermal Resistance Junction-ambient	Max	60	$^{\circ}C/W$
$R_{thj-amb}$	Thermal Resistance Case-sink	Typ	0.5	$^{\circ}C/W$
$T_1$	Maximum Lead Temperature For Soldering Purpose		300	$^{\circ}C$

## AVALANCHE CHARACTERISTICS

Symbol	Parameter	Max Value	Unit
$I_{AR}$	Avalanche Current, Repetitive or Not-Repetitive (pulse width limited by $T_J$ max, $\delta < 1\%$ )	2.7	A
$E_{AS}$	Single Pulse Avalanche Energy (starting $T_J = 25^{\circ}C$ , $I_D = I_{AR}$ , $V_{DD} = 50$ V)	200	mJ
$E_{AR}$	Repetitive Avalanche Energy (pulse width limited by $T_J$ max, $\delta < 1\%$ )	5	mJ
$I_{AR}$	Avalanche Current, Repetitive or Not-Repetitive ( $T_c = 100^{\circ}C$ , pulse width limited by $T_J$ max, $\delta < 1\%$ )	1.6	A

ELECTRICAL CHARACTERISTICS ( $T_{case} = 25^{\circ}C$  unless otherwise specified)

OFF

Symbol	Parameter	Test Conditions	Min.	Typ.	Max.	Unit
$V_{(BR)DSS}$	Drain-source Breakdown Voltage	$I_D = 250 \mu A$ $V_{GS} = 0$	500			V
$I_{DSS}$	Zero Gate Voltage Drain Current ( $V_{GS} = 0$ )	$V_{DS} = \text{Max Rating}$ $V_{DS} = \text{Max Rating} \times 0.8$ $T_c = 125^{\circ}C$			250 1000	$\mu A$ $\mu A$
$I_{GSS}$	Gate-body Leakage Current ( $V_{DS} = 0$ )	$V_{GS} = \pm 20$ V			$\pm 100$	nA

ON (\*)

Symbol	Parameter	Test Conditions	Min.	Typ.	Max.	Unit
$V_{GS(th)}$	Gate Threshold Voltage	$V_{DS} = V_{GS}$ $I_D = 250 \mu A$	2	3	4	V
$R_{DS(on)}$	Static Drain-source On Resistance	$V_{GS} = 10$ V $I_D = 1.5$ A $V_{GS} = 10$ V $I_D = 1.5$ A $T_c = 100^{\circ}C$		2.5	4 8	$\Omega$ $\Omega$
$I_{D(on)}$	On State Drain Current	$V_{DS} > I_{D(on)} \times R_{DS(on)max}$ $V_{GS} = 10$ V	1.7			A

DYNAMIC

Symbol	Parameter	Test Conditions	Min.	Typ.	Max.	Unit
$g_{fs} (*)$	Forward Transconductance	$V_{DS} > I_{D(on)} \times R_{DS(on)max}$ $I_D = 1.5$ A	0.8	1.93		S
$C_{iss}$	Input Capacitance	$V_{DS} = 25$ V $f = 1$ MHz $V_{GS} = 0$		350	460	pF
$C_{oss}$	Output Capacitance			60	80	pF
$C_{rfs}$	Reverse Transfer Capacitance			25	35	pF

**ELECTRICAL CHARACTERISTICS** (continued)

**SWITCHING ON**

Symbol	Parameter	Test Conditions	Min.	Typ.	Max.	Unit
$t_{d(on)}$	Turn-on Time	$V_{DD} = 250\text{ V}$ $I_D = 1.5\text{ A}$		35	45	ns
$t_r$	Rise Time	$R_G = 50\ \Omega$ $V_{GS} = 10\text{ V}$ (see test circuit, figure 3)		85	110	ns
$(di/dt)_{on}$	Turn-on Current Slope	$V_{DD} = 400\text{ V}$ $I_D = 3\text{ A}$ $R_G = 50\ \Omega$ $V_{GS} = 10\text{ V}$ (see test circuit, figure 5)		120		A/ $\mu$ s
$Q_g$	Total Gate Charge	$V_{DD} = 400\text{ V}$ $I_D = 3\text{ A}$ $V_{GS} = 10\text{ V}$		25	35	nC
$Q_{gs}$	Gate-Source Charge			6		nC
$Q_{gd}$	Gate-Drain Charge			11		nC

**SWITCHING OFF**

Symbol	Parameter	Test Conditions	Min.	Typ.	Max.	Unit
$t_{rr(Voff)}$	Off-voltage Rise Time	$V_{DD} = 400\text{ V}$ $I_D = 3\text{ A}$		50	65	ns
$t_f$	Fall Time	$R_G = 50\ \Omega$ $V_{GS} = 10\text{ V}$ (see test circuit, figure 5)		20	30	ns
$t_c$	Cross-over Time			80	105	ns

**SOURCE DRAIN DIODE**

Symbol	Parameter	Test Conditions	Min.	Typ.	Max.	Unit
$I_{SD}$	Source-drain Current				1.7	A
$I_{SDM}(\bullet)$	Source-drain Current (pulsed)				6.8	A
$V_{SD}(\ast)$	Forward On Voltage	$I_{SD} = 1.7\text{ A}$ $V_{GS} = 0$			1.6	V
$t_{rr}$	Reverse Recovery Time	$I_{SD} = 2.8\text{ A}$ $di/dt = 100\text{ A}/\mu\text{s}$ $V_{DD} = 100\text{ V}$ $T_j = 150\text{ }^\circ\text{C}$ (see test circuit, figure 5)		380		ns
$Q_{rr}$	Reverse Recovery Charge			3.8		$\mu\text{C}$
$I_{RRM}$	Reverse Recovery Current			20		A

(\*) Pulsed: Pulse duration = 300  $\mu$ s, duty cycle 1.5 %

( $\bullet$ ) Pulse width limited by safe operating area

**Safe Operating Area**

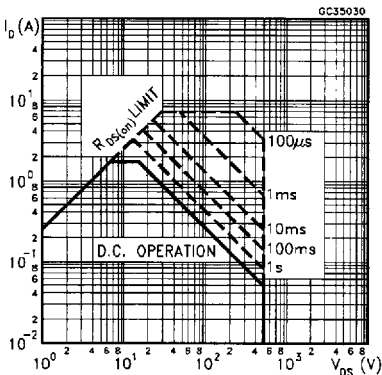

**Thermal Impedance**

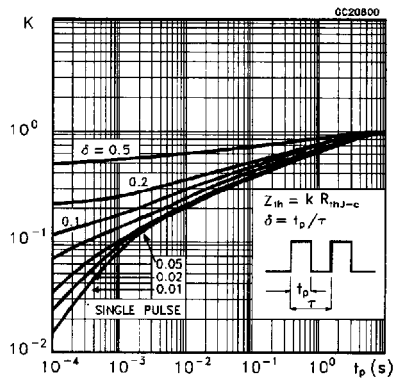

Derating Curve

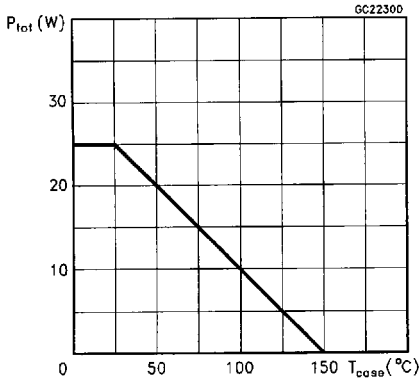

Output Characteristics

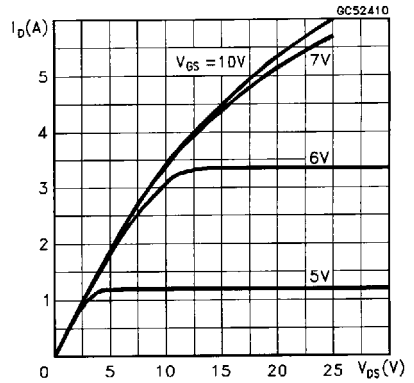

Transfer Characteristics

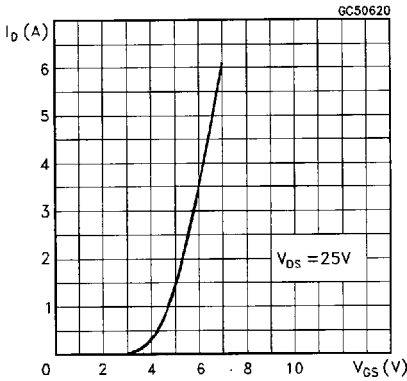

Transconductance

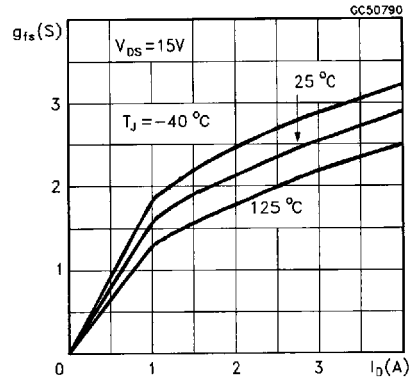

Static Drain-source On Resistance

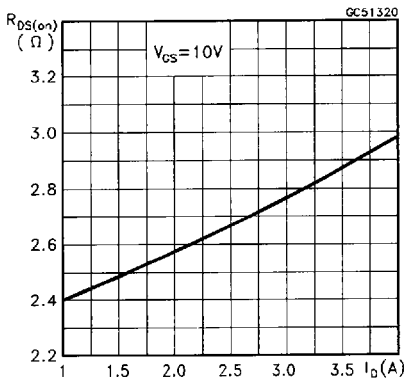

Gate Charge vs Gate-source Voltage

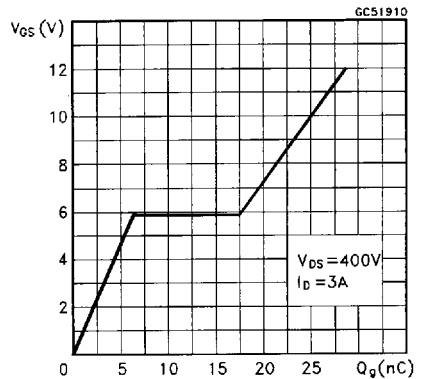

Capacitance Variations

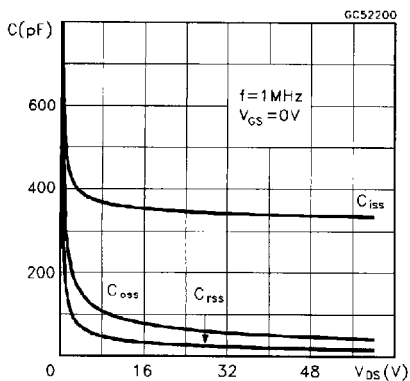

Normalized Gate Threshold Voltage vs Temperature

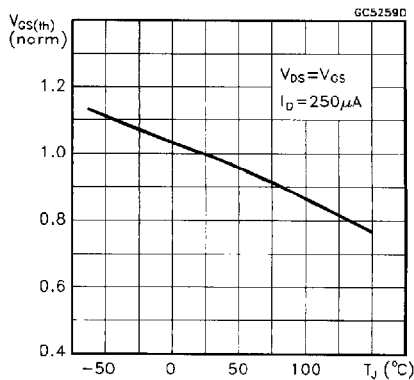

Normalized On Resistance vs Temperature

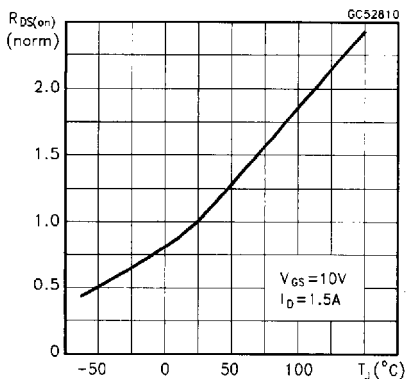

Turn-on Current Slope

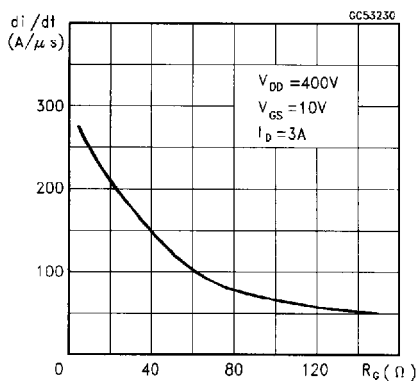

Turn-off Drain-source Voltage Slope

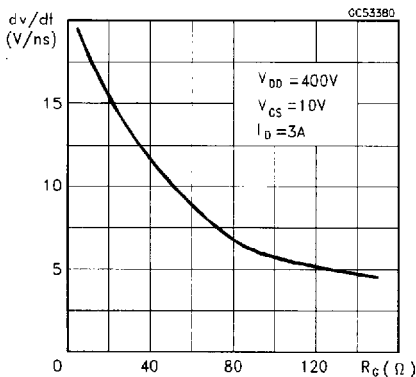

Cross-over Time

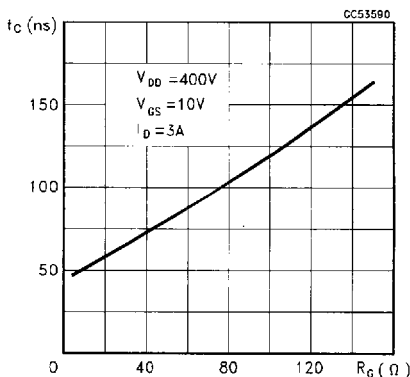

Switching Safe Operating Area

Accidental Overload Area

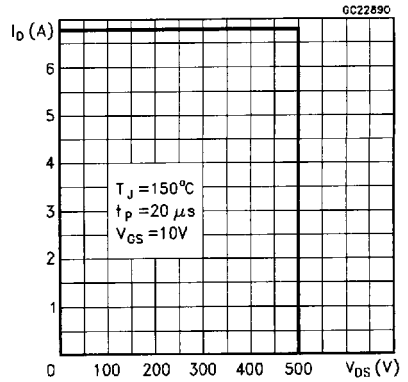
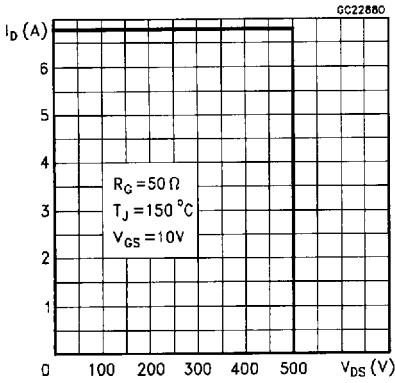

Source-drain Diode Forward Characteristics

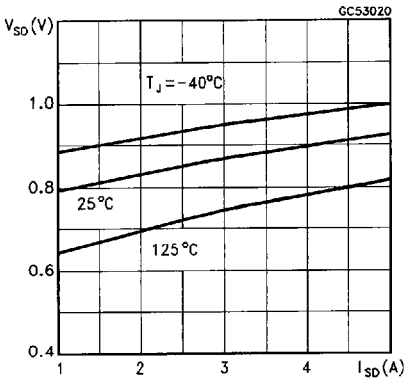
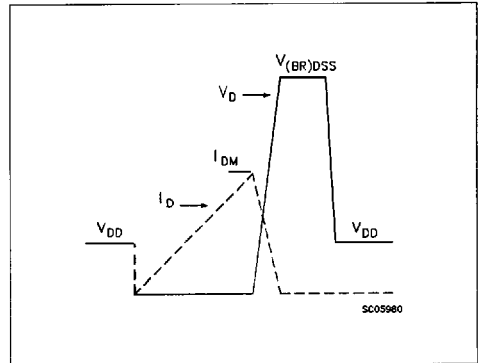
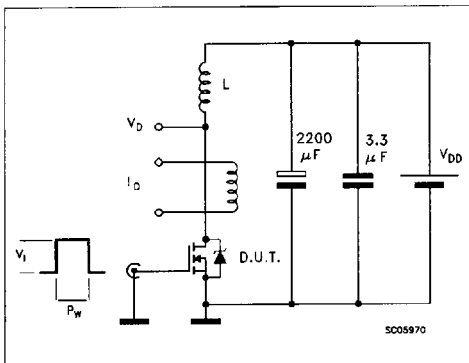
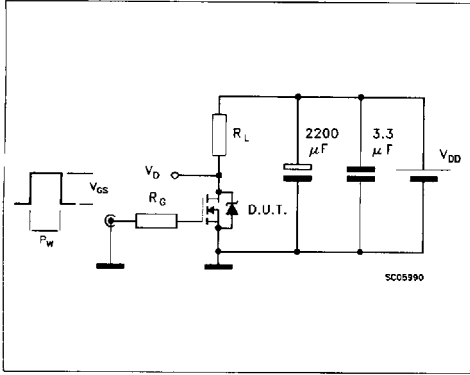

Fig. 1: Unclamped Inductive Load Test Circuits

Fig. 2: Unclamped Inductive Waveforms



**Fig. 3: Switching Times Test Circuits For Resistive Load**



**Fig. 4: Gate Charge Test Circuit**

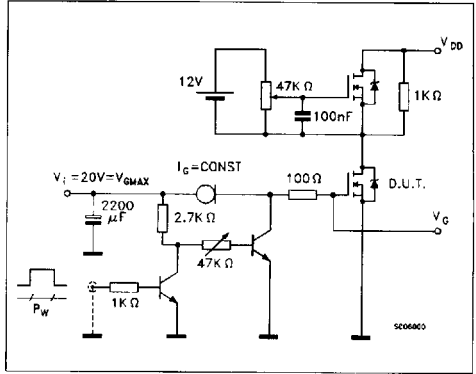

**Fig. 5: Test Circuit For Inductive Load Switching And Diode Recovery Times**

