

BB302M

Build in Biasing Circuit MOS FET IC
VHF RF Amplifier

HITACHI

ADE-208-572 A (Z)
2nd. Edition
September 1997

Features

- Build in Biasing Circuit; To reduce using parts cost & PC board space.
- Low noise characteristics;
(NF = 1.7 dB typ. at f = 200 MHz)
- Withstanding to ESD;
Build in ESD absorbing diode. Withstand up to 240V at C=200pF, Rs=0 conditions.
- Provide mini mold packages; MPAK-4(SOT-143mod)

Outline

MPAK-4

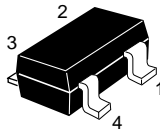

1. Source
2. Gate1
3. Gate2
4. Drain

- Note 1 Marking is “BW-”.
- Note 2 BB302M is individual type number of HITACHI BBFET.

Absolute Maximum Ratings (Ta = 25°C)

Item	Symbol	Ratings	Unit
Drain to source voltage	V_{DS}	12	V
Gate1 to source voltage	V_{G1S}	+10 - 0	V
Gate2 to source voltage	V_{G2S}	±10	V
Drain current	I_D	25	mA
Channel power dissipation	Pch	150	mW
Channel temperature	Tch	150	°C
Storage temperature	Tstg	-55 to +150	°C

Electrical Characteristics (Ta = 25°C)

Item	Symbol	Min	Typ	Max	Unit	Test Conditions
Drain to source breakdown voltage	$V_{(BR)DSS}$	12	—	—	V	$I_D = 200\mu A$ $V_{G1S} = V_{G2S} = 0$
Gate1 to source breakdown voltage	$V_{(BR)G1SS}$	+10	—	—	V	$I_{G1} = +10\mu A$ $V_{G2S} = V_{DS} = 0$
Gate2 to source breakdown voltage	$V_{(BR)G2SS}$	±10	—	—	V	$I_{G2} = \pm 10\mu A$ $V_{G1S} = V_{DS} = 0$
Gate1 to source cutoff current	I_{G1SS}	—	—	+100	nA	$V_{G1S} = +9V$ $V_{G2S} = V_{DS} = 0$
Gate2 to source cutoff current	I_{G2SS}	—	—	±100	nA	$V_{G2S} = \pm 9V$ $V_{G1S} = V_{DS} = 0$
Gate1 to source cutoff voltage	$V_{G1S(off)}$	0.4	—	1.0	V	$V_{DS} = 9V, V_{G2S} = 6V$ $I_D = 100\mu A$
Gate2 to source cutoff voltage	$V_{G2S(off)}$	0.4	—	1.0	V	$V_{DS} = 9V, V_{G1S} = 9V$ $I_D = 100\mu A$
Drain current	$I_{D(op)}$	9	13	18	mA	$V_{DS} = 9V, V_{G1} = 9V$ $V_{G2S} = 6V, R_G = 120k\Omega$
Forward transfer admittance	$ y_{fs} $	15	20	—	mS	$V_{DS} = 9V, V_{G1} = 9V$ $V_{G2S} = 6V$ $R_G = 120k\Omega, f = 1kHz$
Input capacitance	C_{iss}	2.2	3.0	4.0	pF	$V_{DS} = 9V, V_{G1} = 9V$
Output capacitance	C_{oss}	0.8	1.1	1.5	pF	$V_{G2S} = 6V, R_G = 120k\Omega$
Reverse transfer capacitance	C_{rss}	—	0.017	0.04	pF	$f = 1MHz$
Power gain	PG	22	26	—	dB	$V_{DS} = 9V, V_{G1} = 9V$ $V_{G2S} = 6V$
Noise figure	NF	—	1.7	2.2	dB	$R_G = 120k\Omega$ $f = 200MHz$

Main Characteristics

Test Circuit for Operating Items ($I_{D(op)}$, $|y_{fs}|$, C_{iss} , C_{oss} , C_{rss} , NF, PG)

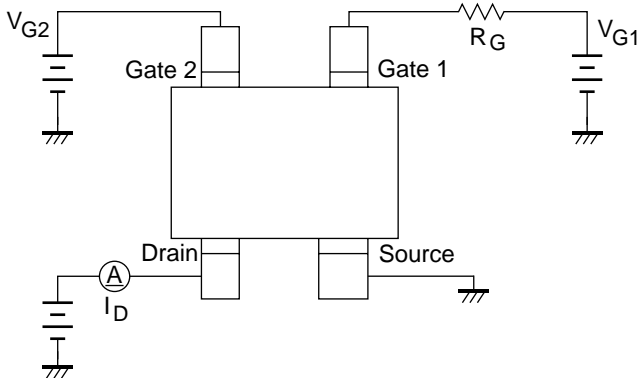

Application Circuit

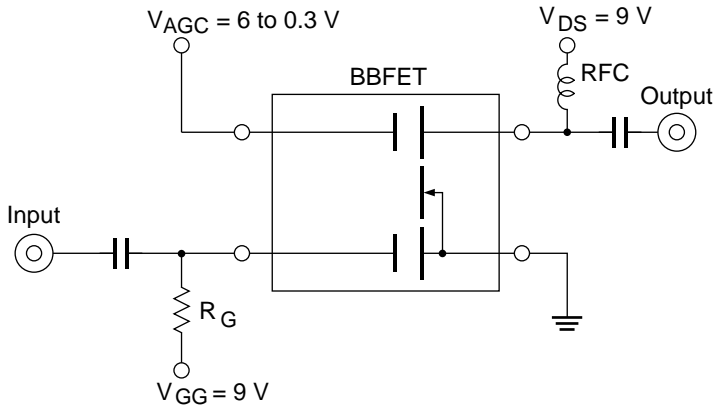

Maximum Channel Power Dissipation Curve

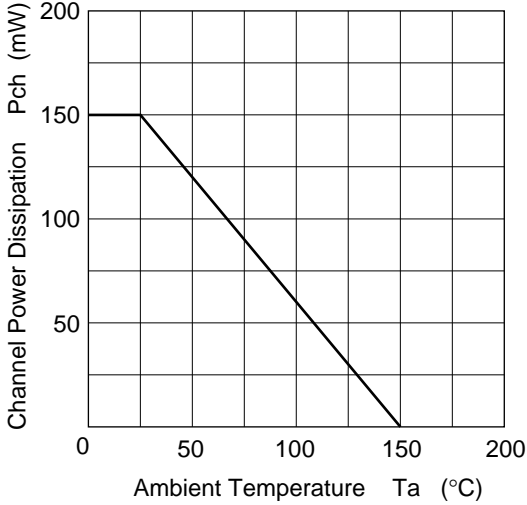

Typical Output Characteristics

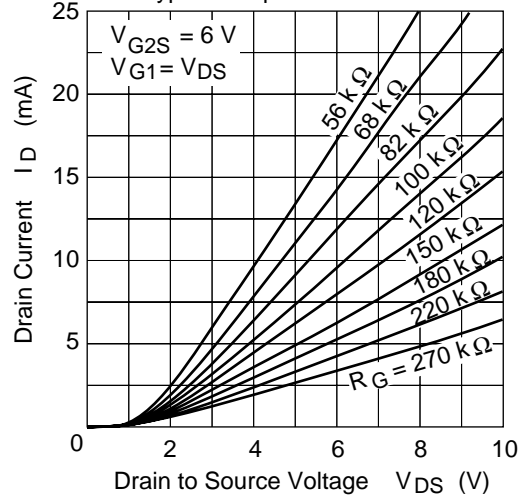

Drain Current vs. Gate2 to Source Voltage

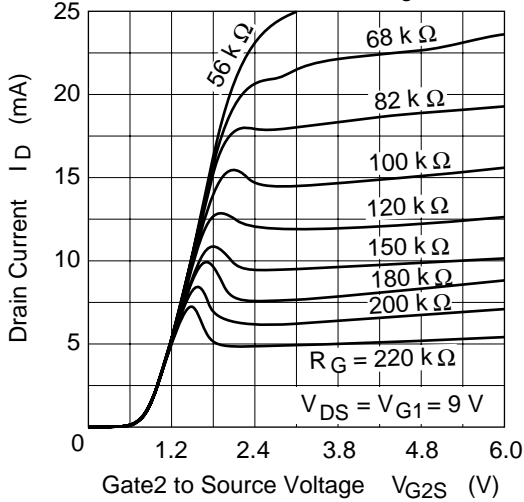

Drain Current vs. Gate1 Voltage

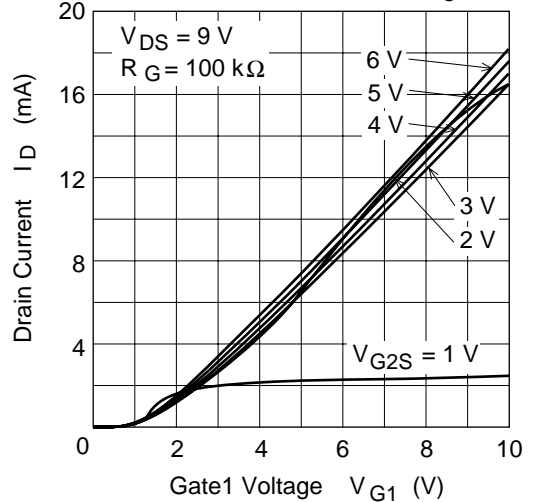

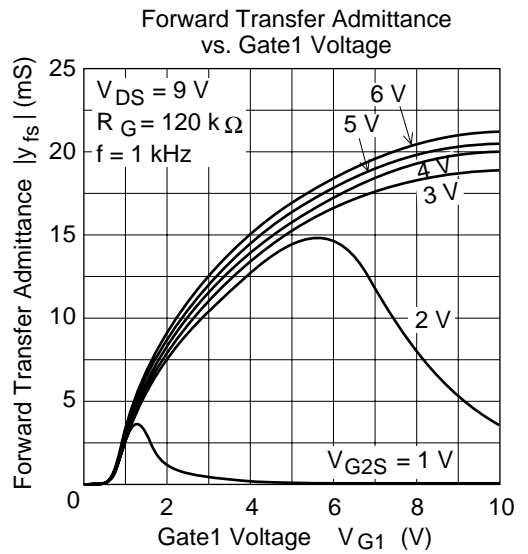
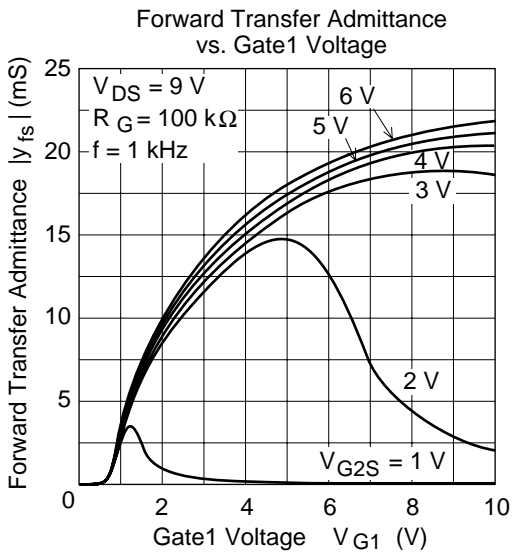
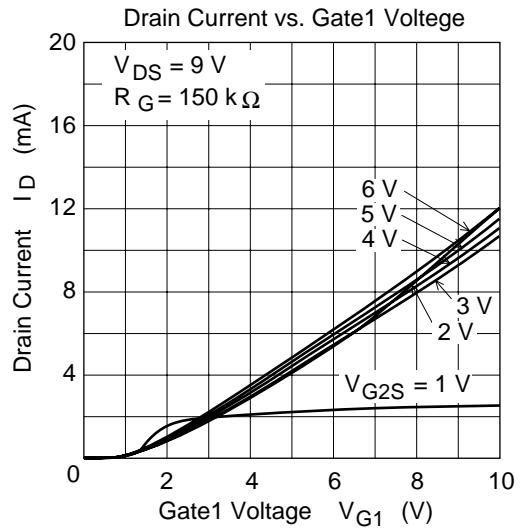
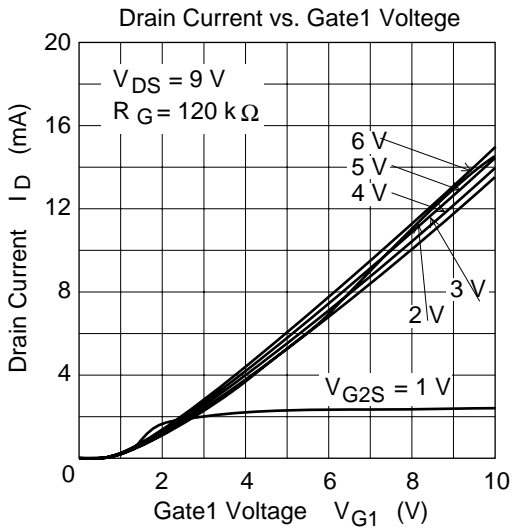

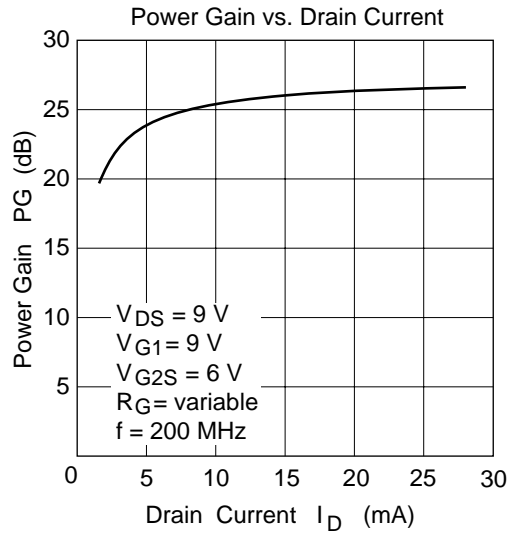
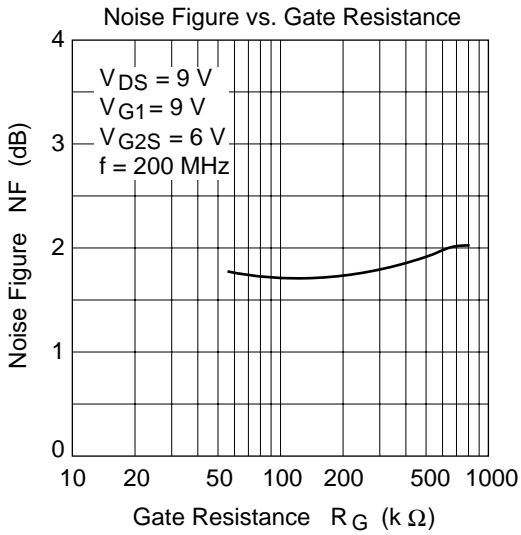
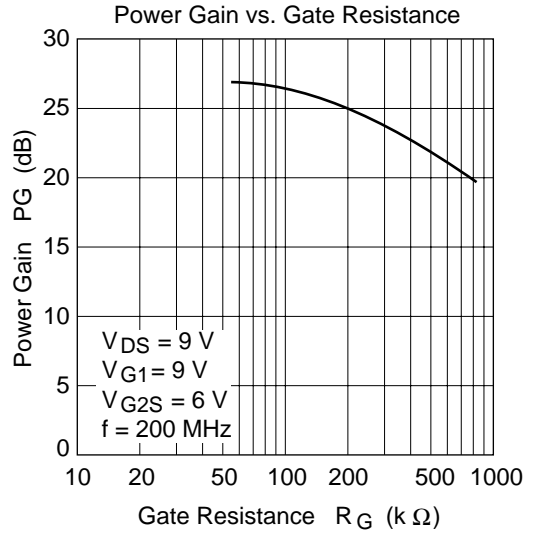
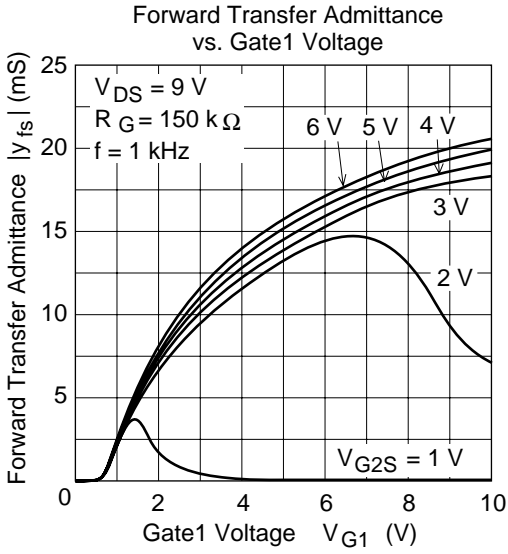

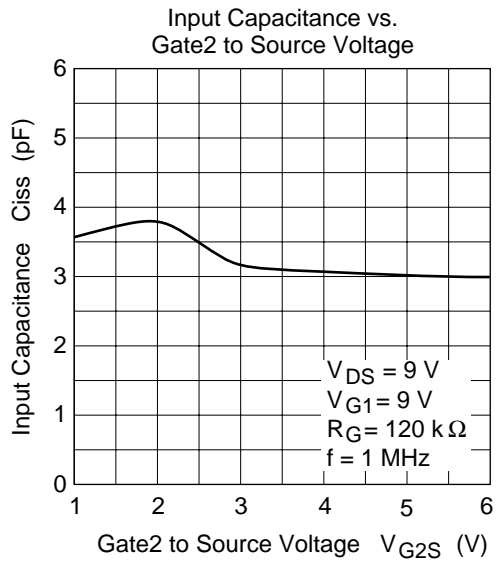
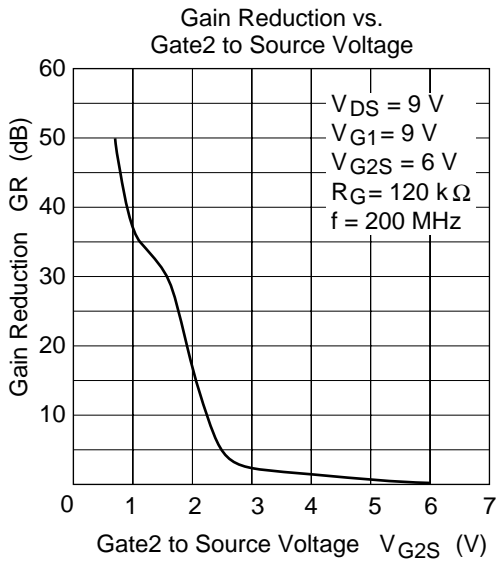
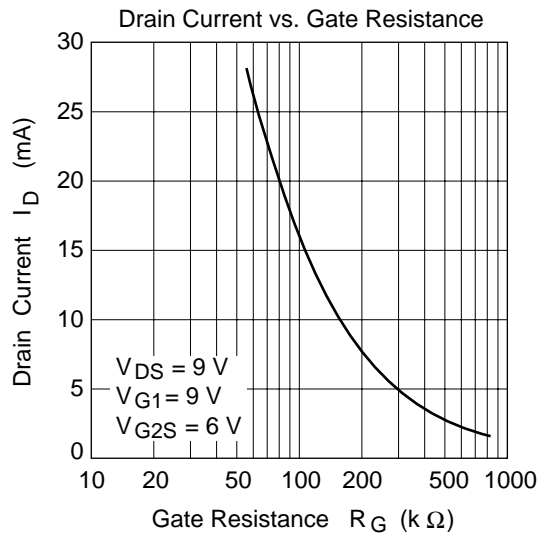
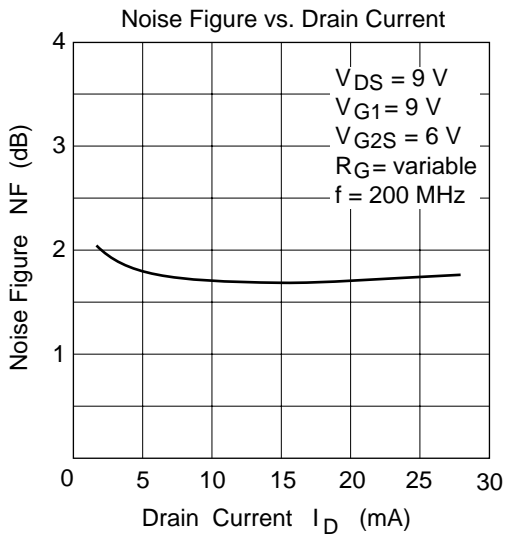

S11 Parameter vs. Frequency

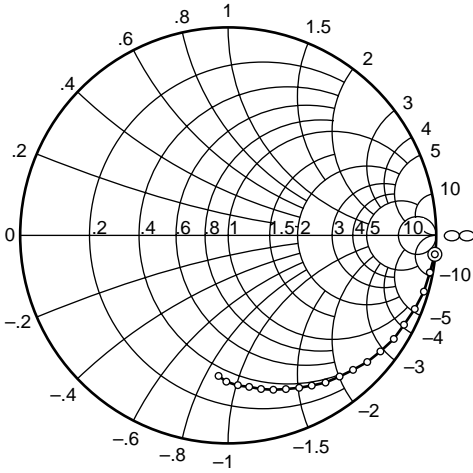

Test Condition : $V_{DS} = 9\text{ V}$, $V_{G1} = 9\text{ V}$
 $V_{G2S} = 6\text{ V}$, $R_G = 120\text{ k}\Omega$
 50 to 1000 MHz (50 MHz step)

⊙—○

S21 Parameter vs. Frequency

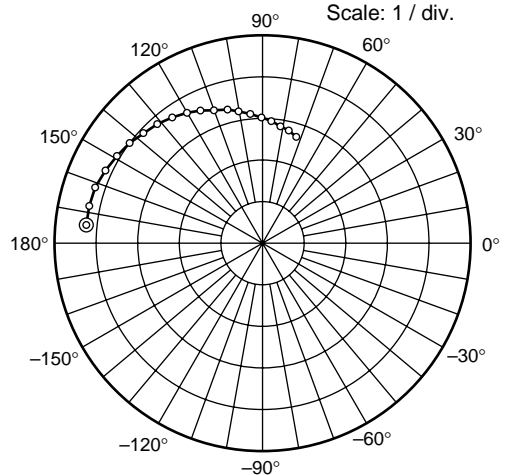

Test Condition : $V_{DS} = 9\text{ V}$, $V_{G1} = 9\text{ V}$
 $V_{G2S} = 6\text{ V}$, $R_G = 120\text{ k}\Omega$
 50 to 1000 MHz (50 MHz step)

⊙—○

S12 Parameter vs. Frequency

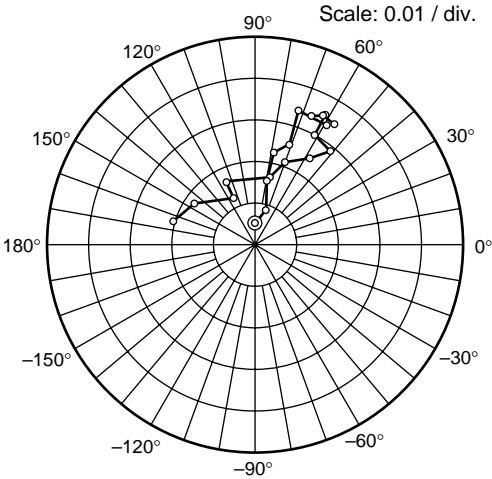

Test Condition : $V_{DS} = 9\text{ V}$, $V_{G1} = 9\text{ V}$
 $V_{G2S} = 6\text{ V}$, $R_G = 120\text{ k}\Omega$
 50 to 1000 MHz (50 MHz step)

⊙—○

S22 Parameter vs. Frequency

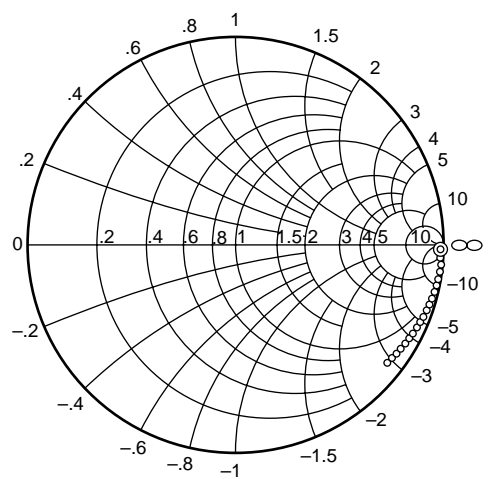

Test Condition : $V_{DS} = 9\text{ V}$, $V_{G1} = 9\text{ V}$
 $V_{G2S} = 6\text{ V}$, $R_G = 120\text{ k}\Omega$
 50 to 1000 MHz (50 MHz step)

⊙—○

Sparameter ($V_{DS} = V_{G1} = 9V$, $V_{G2S} = 6V$, $R_G = 120k\Omega$, $Z_o = 50\Omega$)

f (MHz)	S11		S21		S12		S22	
	MAG	ANG	MAG	ANG	MAG	ANG	MAG	ANG
50	0.988	-5.2	2.13	174.1	0.00052	90.0	0.985	-1.3
100	0.986	-10.4	2.13	167.9	0.00087	72.5	0.993	-3.6
150	0.979	-16.0	2.12	161.6	0.00156	79.4	0.992	-5.5
200	0.964	-21.5	2.08	155.2	0.00226	78.4	0.990	-7.5
250	0.948	-26.9	2.04	149.1	0.00254	71.0	0.987	-9.6
300	0.939	-32.0	2.00	143.0	0.00339	72.0	0.985	-11.4
350	0.920	-37.3	1.95	137.3	0.00335	59.0	0.982	-13.3
400	0.904	-42.3	1.91	131.5	0.00338	66.3	0.978	-15.3
450	0.885	-47.1	1.86	125.7	0.00351	62.2	0.974	-17.1
500	0.864	-51.7	1.81	120.1	0.00347	56.6	0.970	-18.9
550	0.848	-56.5	1.76	115.1	0.00355	61.5	0.966	-21.0
600	0.826	-60.9	1.70	110.1	0.00300	61.4	0.961	-22.7
650	0.808	-65.0	1.66	104.7	0.00289	51.1	0.957	-24.5
700	0.789	-69.4	1.61	100.3	0.00246	57.6	0.952	-26.6
750	0.773	-73.7	1.56	95.4	0.00211	70.0	0.947	-28.3
800	0.755	-77.9	1.51	90.5	0.00166	77.5	0.943	-30.2
850	0.735	-82.1	1.47	85.9	0.00165	114.5	0.937	-32.2
900	0.721	-86.3	1.42	81.3	0.00123	114.5	0.933	-34.1
950	0.703	-90.7	1.39	76.9	0.00176	145.8	0.927	-35.9
1000	0.677	-93.9	1.34	72.4	0.00204	164.0	0.923	-37.9

Package Dimensions

Unit: mm

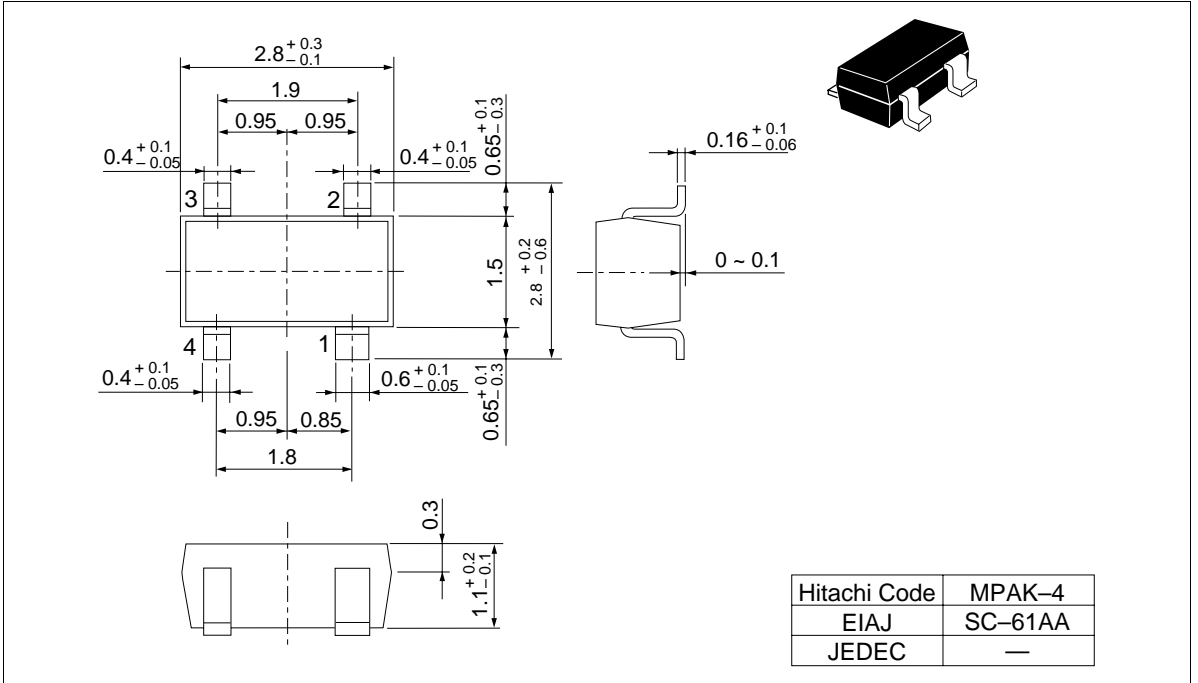

Cautions

1. Hitachi neither warrants nor grants licenses of any rights of Hitachi's or any third party's patent, copyright, trademark, or other intellectual property rights for information contained in this document. Hitachi bears no responsibility for problems that may arise with third party's rights, including intellectual property rights, in connection with use of the information contained in this document.
2. Products and product specifications may be subject to change without notice. Confirm that you have received the latest product standards or specifications before final design, purchase or use.
3. Hitachi makes every attempt to ensure that its products are of high quality and reliability. However, contact Hitachi's sales office before using the product in an application that demands especially high quality and reliability or where its failure or malfunction may directly threaten human life or cause risk of bodily injury, such as aerospace, aeronautics, nuclear power, combustion control, transportation, traffic, safety equipment or medical equipment for life support.
4. Design your application so that the product is used within the ranges guaranteed by Hitachi particularly for maximum rating, operating supply voltage range, heat radiation characteristics, installation conditions and other characteristics. Hitachi bears no responsibility for failure or damage when used beyond the guaranteed ranges. Even within the guaranteed ranges, consider normally foreseeable failure rates or failure modes in semiconductor devices and employ systemic measures such as fail-safes, so that the equipment incorporating Hitachi product does not cause bodily injury, fire or other consequential damage due to operation of the Hitachi product.
5. This product is not designed to be radiation resistant.
6. No one is permitted to reproduce or duplicate, in any form, the whole or part of this document without written approval from Hitachi.
7. Contact Hitachi's sales office for any questions regarding this document or Hitachi semiconductor products.

HITACHI

Hitachi, Ltd.

Semiconductor & Integrated Circuits.
Nippon Bldg., 2-6-2, Ohte-machi, Chiyoda-ku, Tokyo 100-0004, Japan
Tel: Tokyo (03) 3270-2111 Fax: (03) 3270-5109

URL North America : <http://semiconductor.hitachi.com/>
 Europe : <http://www.hitachi-eu.com/hel/ecg>
 Asia (Singapore) : <http://www.has.hitachi.com.sg/grp3/sicd/index.htm>
 Asia (Taiwan) : http://www.hitachi.com.tw/E/Product/SICD_Frame.htm
 Asia (HongKong) : <http://www.hitachi.com.hk/eng/bo/grp3/index.htm>
 Japan : <http://www.hitachi.co.jp/Sicd/indx.htm>

For further information write to:

Hitachi Semiconductor
(America) Inc.
179 East Tasman Drive,
San Jose, CA 95134
Tel: <1> (408) 433-1990
Fax: <1>(408) 433-0223

Hitachi Europe GmbH
Electronic components Group
Dornacher Straße 3
D-85622 Feldkirchen, Munich
Germany
Tel: <49> (89) 9 9180-0
Fax: <49> (89) 9 29 30 00

Hitachi Europe Ltd.
Electronic Components Group.
Whitebrook Park
Lower Cookham Road
Maidenhead
Berkshire SL6 8YA, United Kingdom
Tel: <44> (1628) 585000
Fax: <44> (1628) 778322

Hitachi Asia Pte. Ltd.
16 Collyer Quay #20-00
Hitachi Tower
Singapore 049318
Tel: 535-2100
Fax: 535-1533

Hitachi Asia Ltd.
Taipei Branch Office
3F, Hung Kuo Building, No.167,
Tun-Hwa North Road, Taipei (105)
Tel: <886> (2) 2718-3666
Fax: <886> (2) 2718-8180

Hitachi Asia (Hong Kong) Ltd.
Group III (Electronic Components)
7/F., North Tower, World Finance Centre,
Harbour City, Canton Road, Tsim Sha Tsui,
Kowloon, Hong Kong
Tel: <852> (2) 735 9218
Fax: <852> (2) 730 0281
Telex: 40815 HITEC HX

Copyright © Hitachi, Ltd., 1998. All rights reserved. Printed in Japan.