



Typical Applications

The HMC292LC3B is ideal for:

- Point-to-Point Radios
- Point-to-Mult-Point Radios & VSAT
- Test Equipment & Sensors
- Military End-Use

Features

- Passive: No DC Bias Required
- Input IP3: +20 dBm
- LO/RF Isolation: 40 dB
- Wide IF Bandwidth: DC - 8 GHz
- RoHS Compliant 3x3 mm SMT Package

Functional Diagram

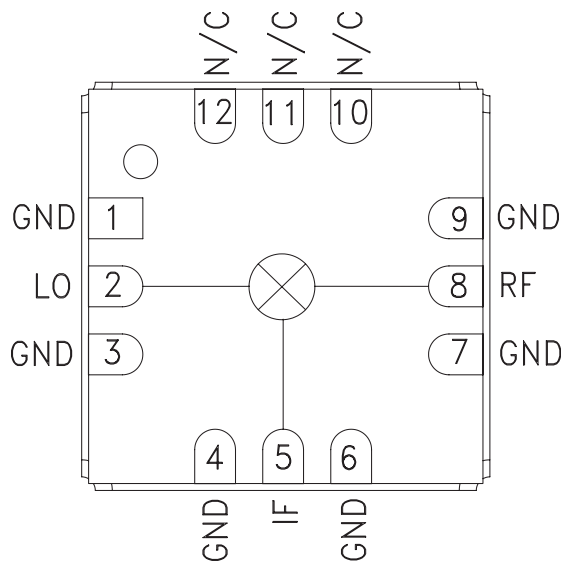

General Description

The HMC292LC3B is a general purpose passive double balanced mixer in a leadless RoHS-Compliant SMT package that can be used as an upconverter or downconverter between 16 and 30 GHz. This mixer requires no external components or matching circuitry. The HMC292LC3B provides excellent LO to RF and LO to IF suppression due to optimized balun structures. The mixer operates with LO drive levels above +9 dBm. The HMC292LC3B eliminates the need for wire bonding, allowing use of surface mount manufacturing techniques.

Electrical Specifications, $T_A = +25^\circ C$, $IF = 1 GHz$, $LO = +13 dBm^*$

Parameter	Min.	Typ.	Max.	Min.	Typ.	Max.	Units
Frequency Range, RF & LO		16 - 26		26 - 30			GHz
Frequency Range, IF		DC - 8		DC - 8			GHz
Conversion Loss		8	11		9.5	12.5	dB
Noise Figure (SSB)		8	11		9.5	12.5	dB
LO to RF Isolation	34	40		32	40		dB
LO to IF Isolation	24	32		28	34		dB
RF to IF Isolation	14	25		24	30		dB
IP3 (Input)		18			21		dBm
IP2 (Input)		48			50		dBm
1 dB Gain Compression (Input)		13			14		dBm

*Unless otherwise noted, all measurements performed as downconverter, $IF = 1 GHz$.



Conversion Gain vs. Temperature

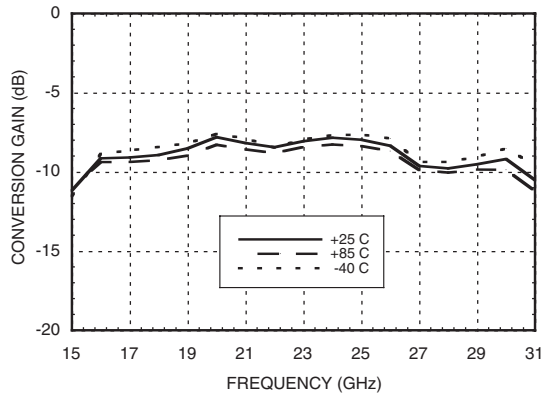

Isolation

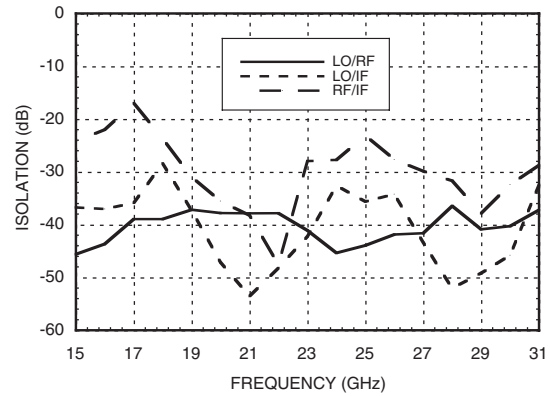

Conversion Gain vs. LO Drive

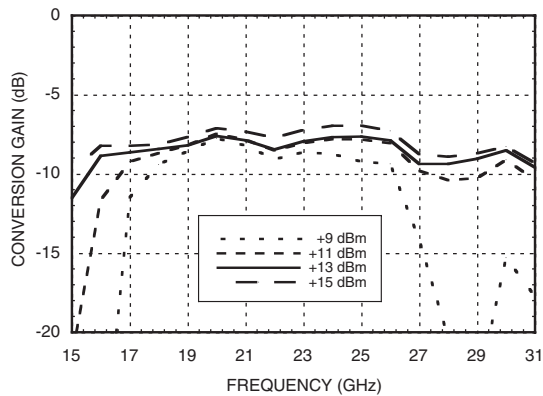

Return Loss

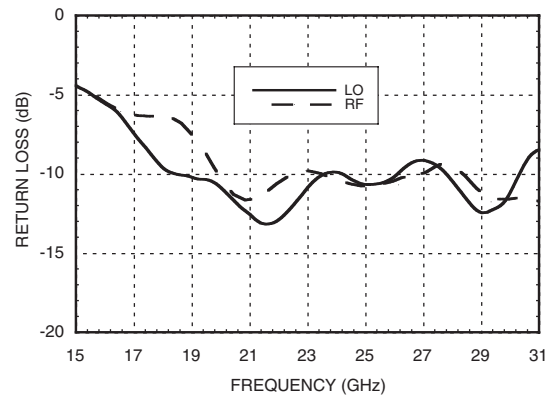

IF Bandwidth

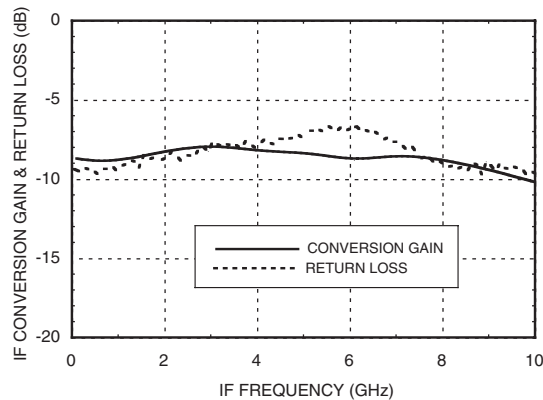

**Upconverter Performance
Conversion Gain vs. LO Drive**

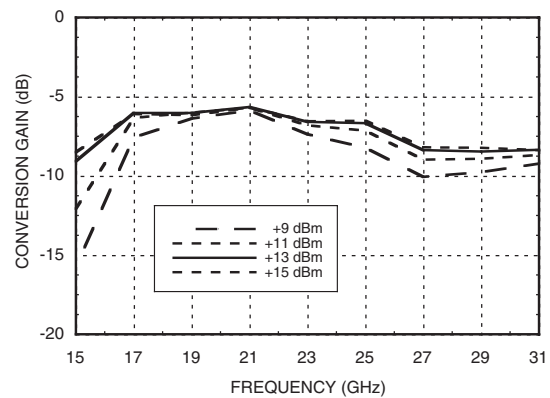



Input IP3 vs. LO Drive *

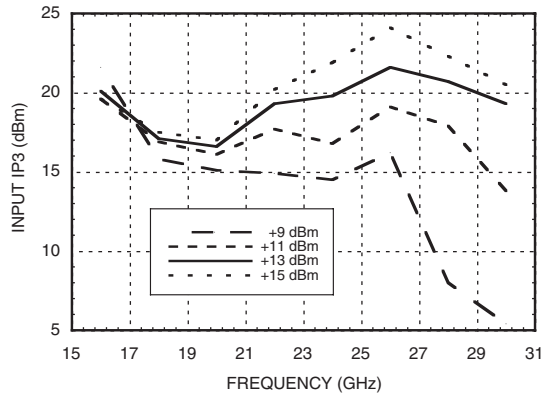

Input IP3 vs. Temperature *

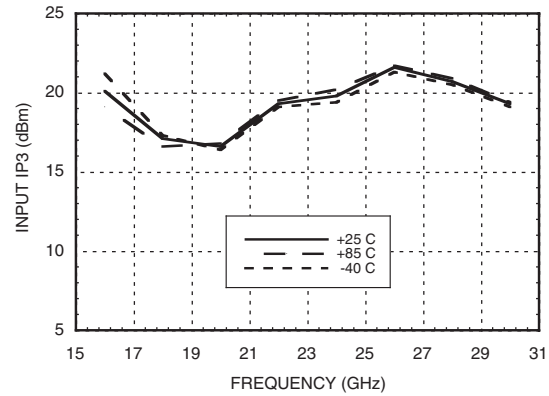

Input IP2 vs. LO Drive *

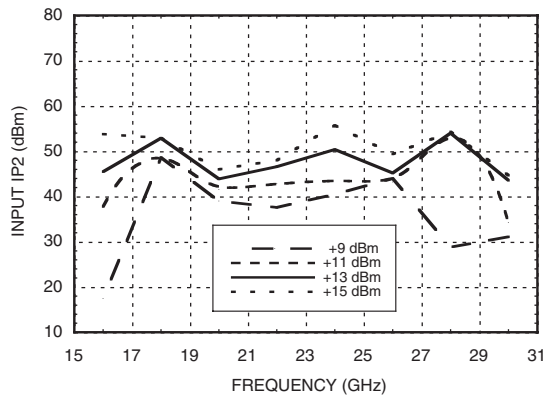

Input IP2 vs. Temperature *

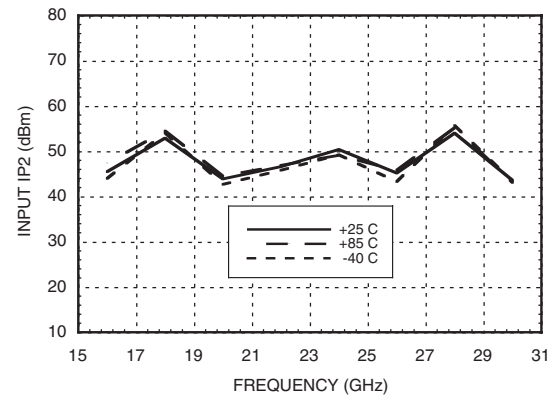

Input P1dB vs. Temperature

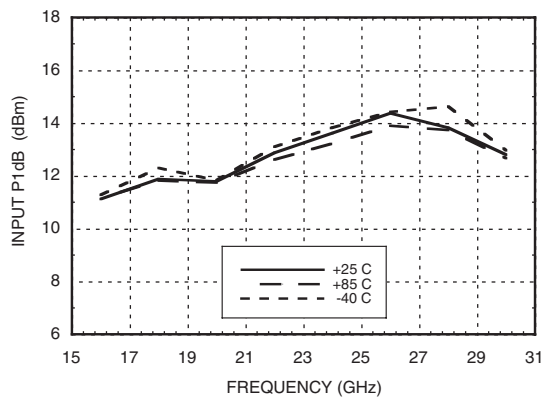

MxN Spurious Outputs

	nLO				
mRF	0	1	2	3	4
0	xx	13	47	xx	xx
1	23	0	50	51	xx
2	87	72	64	72	89
3	xx	89	88	73	92
4	xx	xx	86	95	104

RF = 22 GHz @ -10 dBm
 LO = 21 GHz @ +13 dBm
 All values in dBc below the IF output power level.

* Two-tone input power = -10 dBm each tone, 1 MHz spacing.

Absolute Maximum Ratings

RF / IF Input	+13 dBm
LO Drive	+27 dBm
Channel Temperature	150 °C
Continuous Pdiss (Ta = 85 °C) (derate 4.0 mW/°C above 85 °C)	260 mW
Thermal Resistance (junction to ground paddle)	250 °C/W
Storage Temperature	-65 to +150 °C
Operating Temperature	-40 to +85 °C
ESD Sensitivity (HBM)	Class 1C



ELECTROSTATIC SENSITIVE DEVICE
OBSERVE HANDLING PRECAUTIONS

Outline Drawing

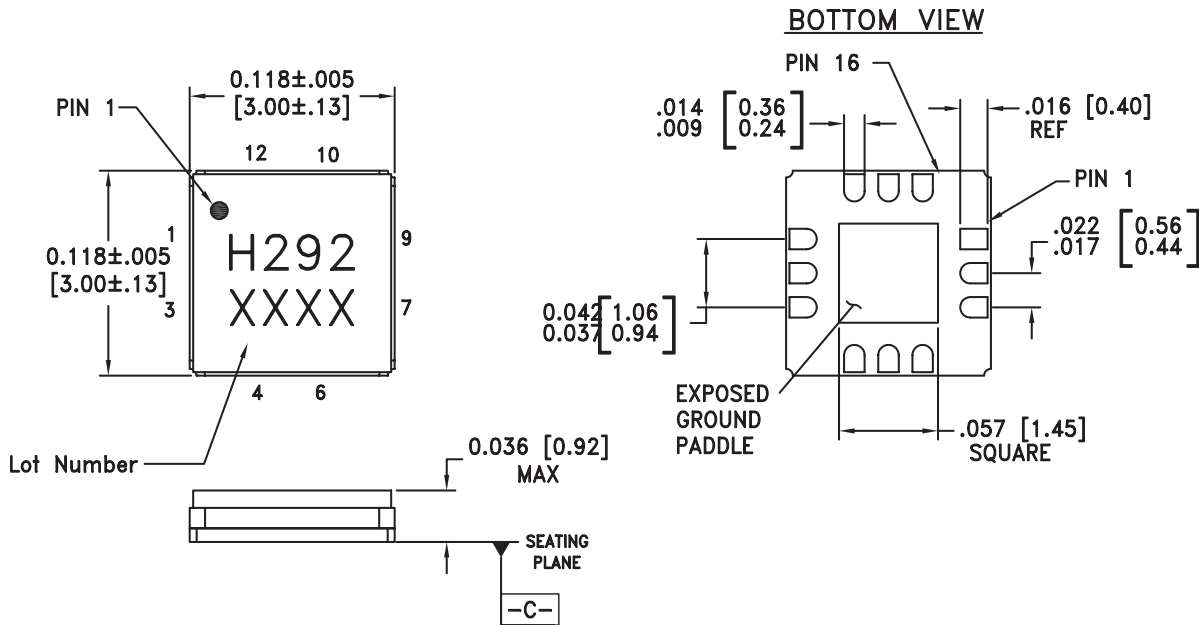

NOTES:

1. PACKAGE BODY MATERIAL: ALUMINA.
2. LEAD AND GROUND PADDLE PLATING: GOLD FLASH OVER NICKEL.
3. DIMENSIONS ARE IN INCHES (MILLIMETERS).
4. LEAD SPACING TOLERANCE IS NON-CUMULATIVE.
5. CHARACTERS TO BE HELVETICA MEDIUM, .025 HIGH, BLACK INK, OR LASER MARK LOCATED APPROX. AS SHOWN.
6. PACKAGE WARP SHALL NOT EXCEED 0.05MM DATUM - C -
7. ALL GROUND LEADS AND GROUND PADDLE MUST BE SOLDERED TO PCB RF GROUND.
8. CLASSIFIED AS MOISTURE SENSITIVITY LEVEL (MSL) 1.

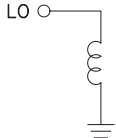
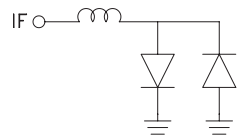
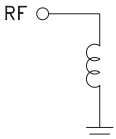

Pin Descriptions

Pin Number	Function	Description	Interface Schematic
1, 3, 4, 6, 7, 9	GND	Package bottom must also be connected to RF/DC ground.	
2	LO	This pin is DC coupled and matched to 50 Ohm from 16 to 30 GHz.	
5	IF	This pin is DC coupled. For applications not requiring operation to DC, this port should be DC blocked externally using a series capacitor whose value has been chosen to pass the necessary IF frequency range. For operation to DC, this pin must not source or sink more than 2 mA of current or part non-function and possible part failure will result.	
8	RF	This pin is DC coupled and matched to 50 Ohm from 16 to 30 GHz.	
10, 11, 12	N/C	No connection required. These pins may be connected to RF/DC ground without affecting performance.	

Evaluation PCB

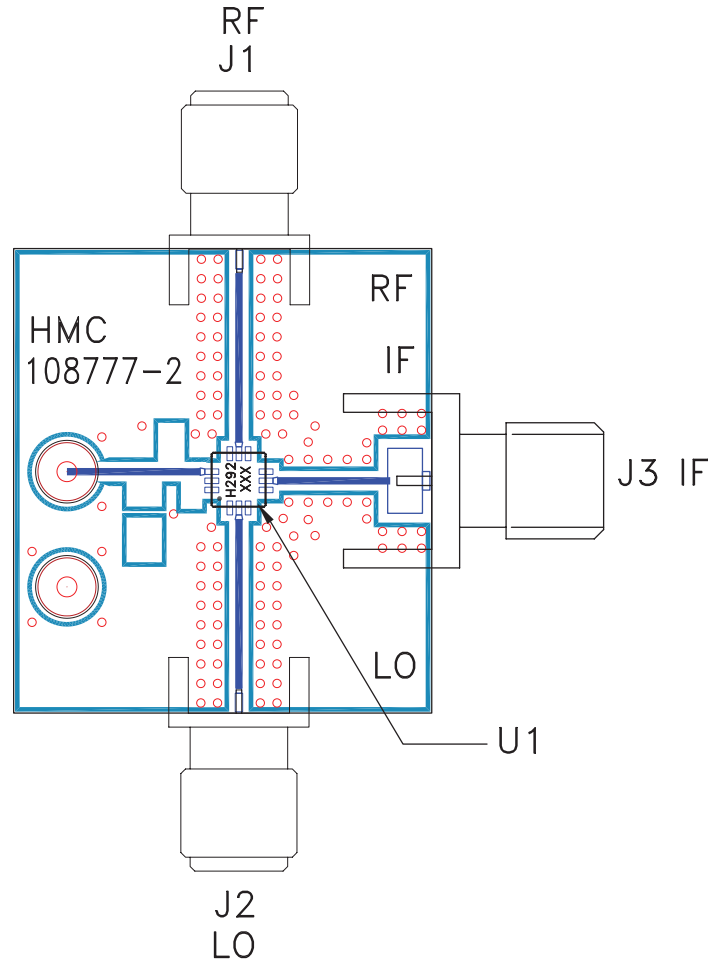

List of Materials for Evaluation PCB 109952 ^[1]

Item	Description
J1 - J2	SRI SMA Connector
J3	Johnson SMA Connector
U1	HMC292LC3B Mixer
PCB [2]	108777 Evaluation PCB

[1] Reference this number when ordering complete evaluation PCB

[2] Circuit Board Material: Rogers 4350

The circuit board used in this application should use RF circuit design techniques. Signal lines should have 50 ohm impedance while the package ground leads and exposed paddle should be connected directly to the ground plane similar to that shown. A sufficient number of VIA holes should be used to connect the top and bottom ground planes. The evaluation board should be mounted to an appropriate heat sink. The evaluation circuit board shown is available from Hittite upon request.