

ML61 Series Positive Voltage Detector

❖ Application

- ◆ Memory Battery Back-up Circuits
- ◆ Microprocessor Reset Circuitry
- ◆ Power Failure Detection
- ◆ Power-on Reset Circuit
- ◆ System Battery Life and Charge Voltage Monitor

❖ Features

- CMOS Low Power Consumption : Typical 1.0uA at $V_{in}=2.0V$
- Selectable Detect Voltage : 1.1V to 6.0V in 0.1V increments
- Highly Accurate : Detect Voltage 1.1V to 1.9V $\pm 3\%$
Detect Voltage 2.0V to 6.0V $\pm 2\%$
- Operating Voltage : 0.8V to 10.0V
- Package Available : SOT23 (150mW), SOT89 (500mW) & TO92 (300mW)

❖ General Description

The ML61 is a group of high-precision and low-power voltage detectors.

The ML61 consists of a highly-accurate and low-power reference voltage source, a comparator, a hysteresis circuit, and an output driver. Detect voltage is very accurate and stable with N-channel open drain and CMOS, are available.

❖ Block Diagram

(1) CMOS Output

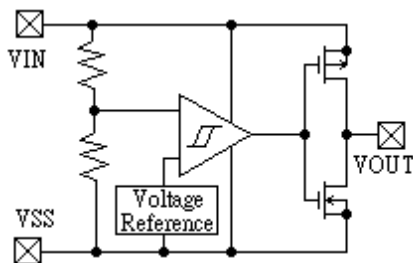

(2) N-Channel Open Drain Output

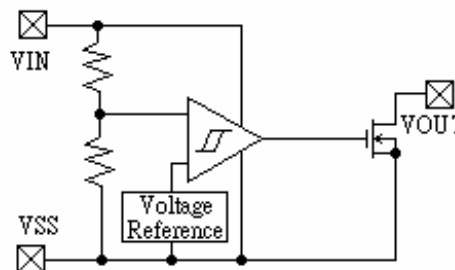

❖ Absolute Maximum Ratings

Parameter	Symbol	Ratings	Units
Input Voltage	V_{IN}	10	V
Output Current	I_{OUT}	50	mA
Output Voltage	V_{OUT}	$V_{SS}-0.3 \sim V_{IN}+0.3$	V
Continuous Total Power Dissipation	SOT-23	150	mW
	SOT-89	500	
	TO-92	300	
Operating Ambient Temperature	T_{opr}	-40 ~ +70	°C
Storage Temperature	T_{stg}	-40 ~ +70	°C

❖ *Electrical Characteristics*

<i>Parameter</i>	<i>Symbol</i>	<i>Conditions</i>	<i>Min</i>	<i>Typ</i>	<i>Max</i>	<i>Units</i>
<i>Detect Voltage</i>	V_{DF}	$V_{DF} = 1.1V \text{ to } 1.9V$	X0.97	V_{DF}	X1.03	V
		$V_{DF} = 2.0V \text{ to } 6.0V$	X0.98	V_{DF}	X1.02	V
<i>Hysteresis Range</i>	V_{HYS}		X0.02	$V_{DF} \times 0.05$	X0.07	V
<i>Supply Current</i>	I_{SS}	$V_{IN} = 1.0V$		0.8	2.0	uA
		$V_{IN} = 2.0V$		1.0	2.5	
		$V_{IN} = 3.0V$		1.3	3.0	
		$V_{IN} = 4.0V$		1.6	3.5	
		$V_{IN} = 5.0V$		2.0	4.0	
<i>Operating Voltage</i>	V_{IN}	$V_{DF} = 1.1 \sim 6.0V$	0.8		10.0	V
<i>Output Current</i>	I_{OUT}	<i>Nch</i> $V_{DS} = 0.5V$ $V_{IN} = 1.0V$ $V_{IN} = 2.0V$ $V_{IN} = 3.0V$ $V_{IN} = 4.0V$ $V_{IN} = 5.0V$		1.0		mA
				3.0		
				5.0		
				11.0		
				13.0		
	<i>Pch</i> $V_{DS} = 2.1V$ $V_{IN} = 8.0V$ (CMOS Output)		-10.0			
<i>Transient Delay Time</i> ($V_{DR} \rightarrow V_{OUT}$ Inversion)	t_{DLY}	<i>While V_{IN} changes from 0.6V to 10V</i>			0.2	ms

❖ Electrical Characteristics By Detector Threshold

Part Number	Standard Detector Accuracy	Detector Threshold			Hysteresis Range		Supply Current		
		V _{DF} (V)			V _{HYS} (V)		I _{SS} (uA)		
		MIN.	TYP.	MAX.	MIN.	MAX.	Condition	TYP.	MAX.
ML61X113XX	3%	1.067	1.100	1.133	V _{DF} x 0.02	V _{DF} x 0.07	V _{IN} = 1.0V	0.8	2.0
ML61X123XX		1.164	1.200	1.236					
ML61X133XX		1.261	1.300	1.339					
ML61X143XX		1.358	1.400	1.442					
ML61X153XX		1.455	1.500	1.545					
ML61X163XX		1.552	1.600	1.648					
ML61X173XX		1.649	1.700	1.751					
ML61X183XX		1.746	1.800	1.854					
ML61X193XX		1.843	1.900	1.957					
ML61X202XX		1.960	2.000	2.040					
ML61X212XX	2.058	2.100	2.142						
ML61X222XX	2.156	2.200	2.244						
ML61X232XX	2.254	2.300	2.346						
ML61X242XX	2.352	2.400	2.448						
ML61X252XX	2.450	2.500	2.550						
ML61X262XX	2.548	2.600	2.652						
ML61X272XX	2.646	2.700	2.754						
ML61X282XX	2.744	2.800	2.856						
ML61X292XX	2.842	2.900	2.958	V _{IN} = 3.0V			1.3	3.0	
ML61X302XX	2.940	3.000	3.060						
ML61X312XX	3.038	3.100	3.162						
ML61X322XX	3.136	3.200	3.264						
ML61X332XX	3.234	3.300	3.366						
ML61X342XX	3.332	3.400	3.468						
ML61X352XX	3.430	3.500	3.570						
ML61X362XX	3.528	3.600	3.672						
ML61X372XX	3.626	3.700	3.774						
ML61X382XX	3.724	3.800	3.876						V _{IN} = 4.0V
ML61X392XX	3.822	3.900	3.978						
ML61X402XX	3.920	4.000	4.080						
ML61X412XX	4.018	4.100	4.182						
ML61X422XX	4.116	4.200	4.284						
ML61X432XX	4.214	4.300	4.386						
ML61X442XX	4.312	4.400	4.488						
ML61X452XX	4.410	4.500	4.590						
ML61X462XX	4.508	4.600	4.692						
ML61X472XX	4.606	4.700	4.794	V _{IN} = 5.0V	2.0	4.0			
ML61X482XX	4.704	4.800	4.896						
ML61X492XX	4.802	4.900	4.998						
ML61X502XX	4.900	5.000	5.100						
ML61X512XX	4.998	5.100	5.202						
ML61X522XX	5.096	5.200	5.304						
ML61X532XX	5.194	5.300	5.406						
ML61X542XX	5.292	5.400	5.508						
ML61X552XX	5.390	5.500	5.610						
ML61X562XX	5.488	5.600	5.712						
ML61X572XX	5.586	5.700	5.814						
ML61X582XX	5.684	5.800	5.916						
ML61X592XX	5.782	5.900	6.018						
ML61X602XX	5.880	6.000	6.120						

Part Number	Operating Voltage		Pch Output Current		Nch Output Current		Transient Delay Time
	V_{IN} (V)		Pch I_{OUT} (mA)		Nch I_{OUT} (mA)		t_{DLY} (ms)
	MIN.	MAX.	Condition	TYP.	Condition	TYP.	MAX.
ML61X113XX	0.8V	10V	$V_{DS} = 2.1V$	-10.0	$V_{DS} = 0.5V$ $V_{IN} = 1.0V$	1.0	0.2
ML61X123XX							
ML61X133XX							
ML61X143XX							
ML61X153XX							
ML61X163XX							
ML61X173XX							
ML61X183XX							
ML61X193XX							
ML61X202XX							
ML61X212XX					$V_{DS} = 0.5V$ $V_{IN} = 2.0V$	3.0	
ML61X222XX							
ML61X232XX							
ML61X242XX							
ML61X252XX							
ML61X262XX							
ML61X272XX							
ML61X282XX							
ML61X292XX							
ML61X302XX							
ML61X312XX					$V_{DS} = 0.5V$ $V_{IN} = 3.0V$	5.0	
ML61X322XX							
ML61X332XX							
ML61X342XX							
ML61X352XX							
ML61X362XX							
ML61X372XX							
ML61X382XX							
ML61X392XX							
ML61X402XX							
ML61X412XX					$V_{DS} = 0.5V$ $V_{IN} = 4.0V$	11.0	
ML61X422XX							
ML61X432XX							
ML61X442XX							
ML61X452XX							
ML61X462XX							
ML61X472XX							
ML61X482XX							
ML61X492XX							
ML61X502XX							
ML61X512XX	$V_{DS} = 0.5V$ $V_{IN} = 5.0V$	13.0					
ML61X522XX							
ML61X532XX							
ML61X542XX							
ML61X552XX							
ML61X562XX							
ML61X572XX							
ML61X582XX							
ML61X592XX							
ML61X602XX							

❖ *Pin Configuration*

SOT-23

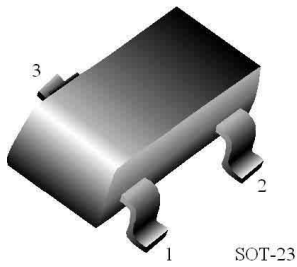

<i>Pin Number</i>	<i>Pin Name</i>	<i>Description</i>
<i>1</i>	<i>VOUT</i>	<i>Supply Voltage Output</i>
<i>2</i>	<i>VSS</i>	<i>Ground</i>
<i>3</i>	<i>VIN</i>	<i>Supply Voltage Input</i>

SOT-89

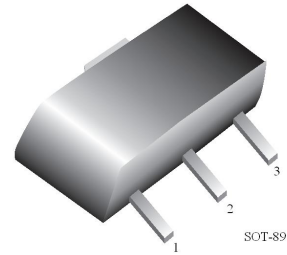

<i>Pin Number</i>	<i>Pin Name</i>	<i>Description</i>
<i>1</i>	<i>VOUT</i>	<i>Supply Voltage Output</i>
<i>2</i>	<i>VIN</i>	<i>Supply Voltage Input</i>
<i>3</i>	<i>VSS</i>	<i>Ground</i>

TO-92

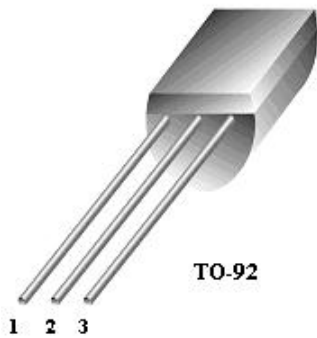

<i>Pin Number</i>	<i>Pin Name</i>	<i>Description</i>
<i>1</i>	<i>VOUT</i>	<i>Supply Voltage Output</i>
<i>2</i>	<i>VIN</i>	<i>Supply Voltage Input</i>
<i>3</i>	<i>VSS</i>	<i>Ground</i>

❖ *Functional Description (Refers to CMOS Output)*

1. Firstly, when a voltage, higher than the Release Voltage (V_{DR}), is applied to the Voltage Input pin (V_{IN}), that voltage will gradually fall. When a voltage higher than the Detect Voltage (V_{DF}) is applied to the Input Voltage pin (V_{IN}), output at V_{OUT} will be equal to the input at the V_{IN} pin. High impedance exists on the Output pin (V_{OUT}) with the N-channel open drain configuration. If the pin is pulled-up, V_{OUT} will be identical to the pull-up voltage.
2. When the input Voltage (V_{IN}) falls below the Detect Voltage (V_{DF}) level, the Output Voltage (V_{OUT}) is equal to the Ground Voltage (V_{SS}) level (detect state). Also applicable to N-channel open drain configuration.
3. When the Input Voltage (V_{IN}) falls below the Minimum Operating Voltage (V_{MIN}) level, output becomes unstable. In the case of N-channel open drain configuration, as the output pin is generally pulled-up, the output will be equal to the pull-up voltage.
4. When the Input Voltage (V_{IN}) rises, output become stable once the voltage has exceeded V_{MIN} . The Output Voltage (V_{OUT}) will remain equal to the Ground Voltage (V_{SS}) level until the Input Voltage (V_{IN}) reaches the Detect Release Voltage (V_{DR}) level.
5. When the Input Voltage (V_{IN}) rises above the Detect Release Voltage (V_{DR}) level, output at the Output pin (V_{OUT}) is equal to V_{IN} . (High impedance exists with the N-channel open drain output configuration and V_{OUT} follows the pull-up voltage.)

Notes :

1. The difference between V_{DR} and V_{DF} represents the Hysteresis Range.
2. The Propagation Delay Time (t_{DLY}) represents the time it takes for the Input Voltage (V_{IN}) to appear at the Output pin (V_{OUT}), once the said voltage has exceeded the Release Voltage (V_{DR}) level.

❖ *Timing Diagram*

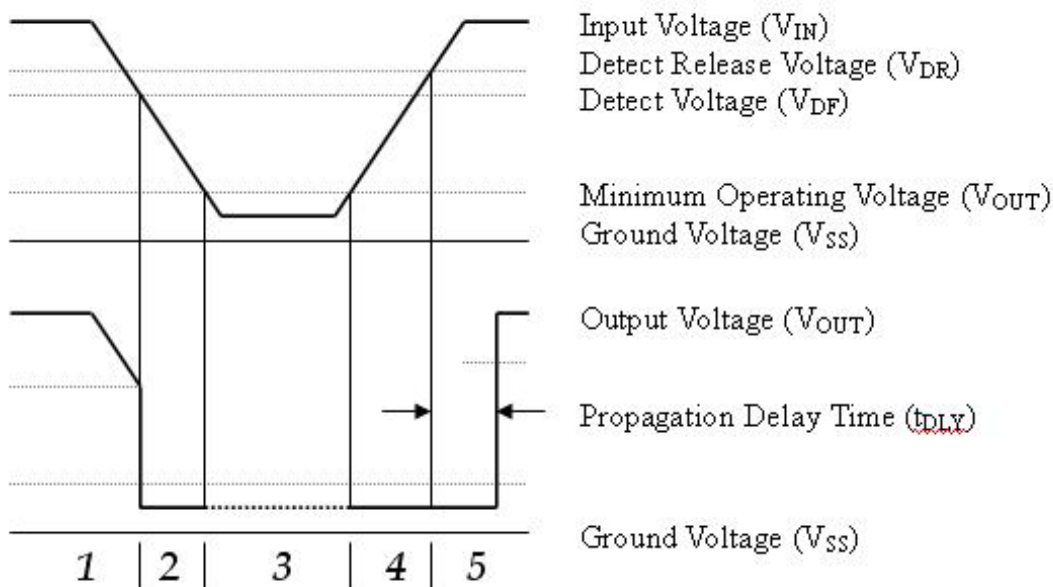

❖ Typical Performance Characteristics

1) Supply Current vs. Input Voltage

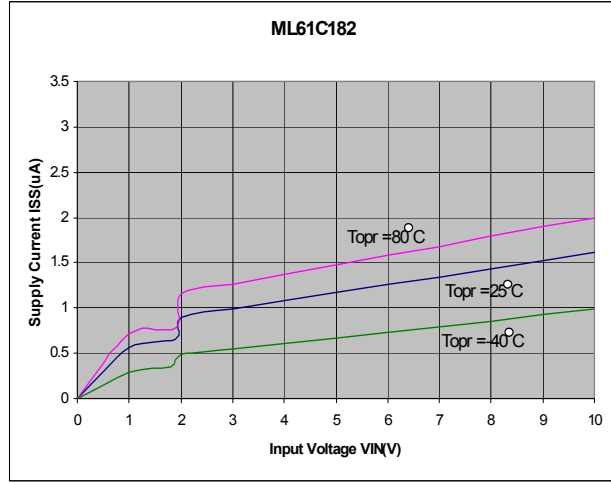
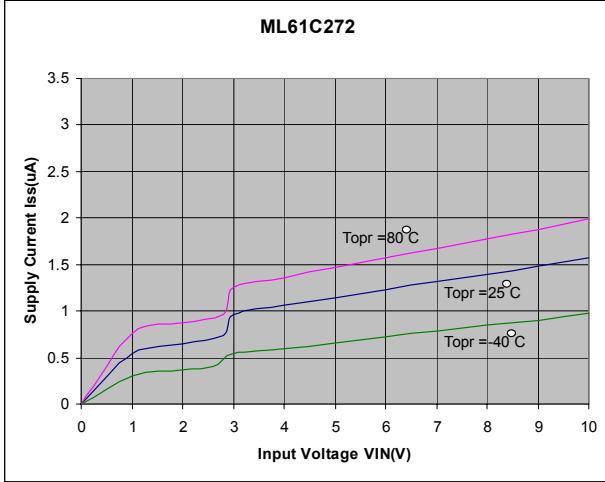

2) Detect, Release Voltage vs. Ambient Temperature

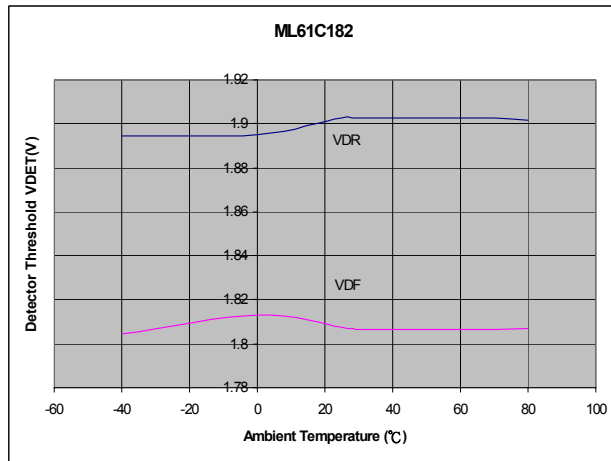
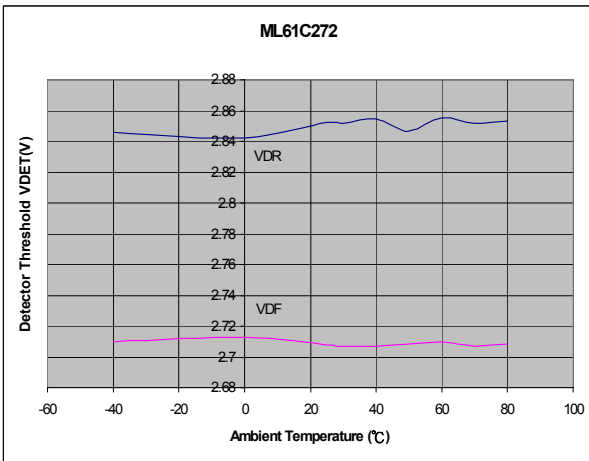

3) Output Voltage vs. Input Voltage

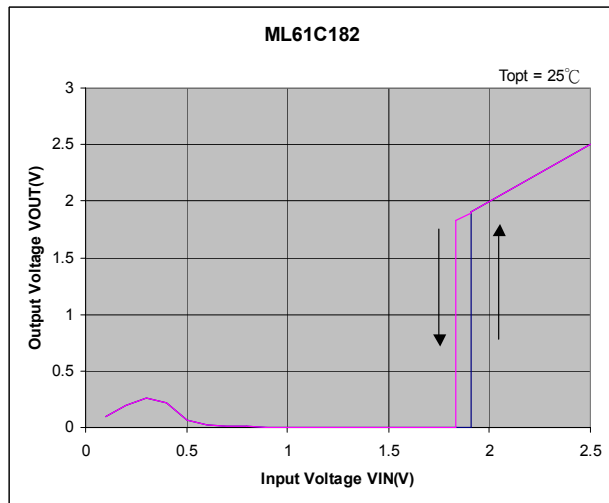
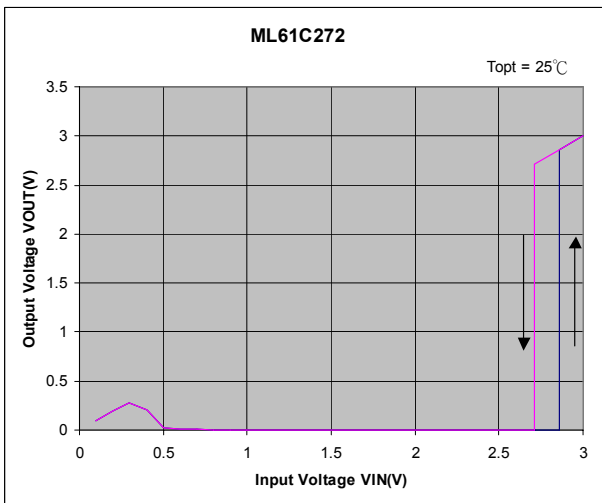

4) N-ch Driver Output Current vs. V_{DS}

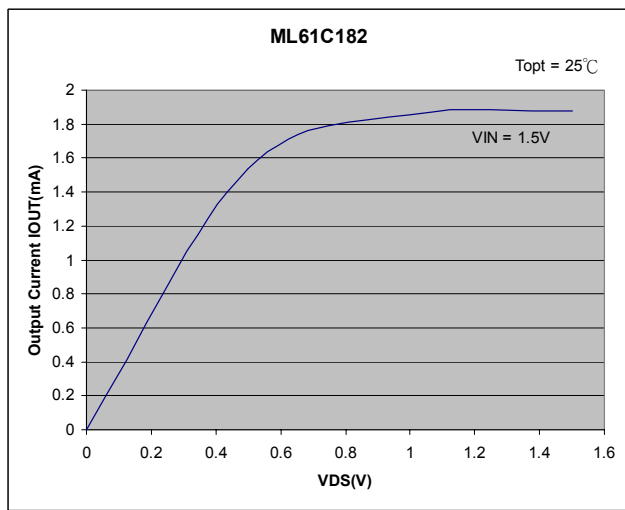
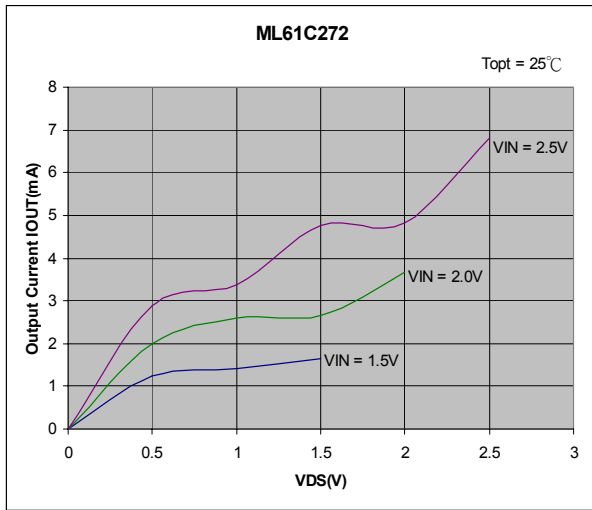

5) N-ch Driver Output Current vs. Input Voltage

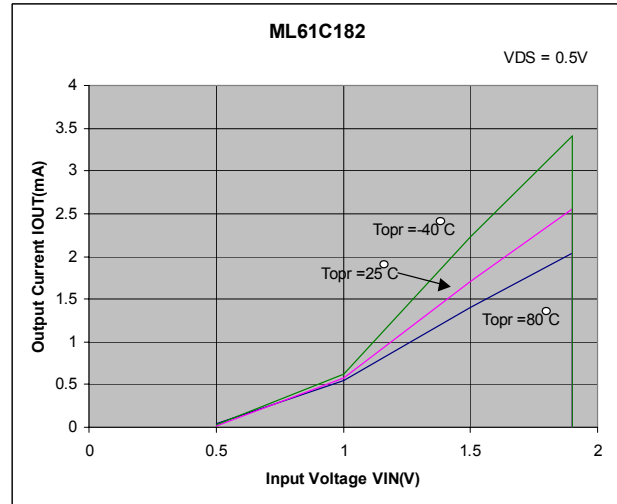
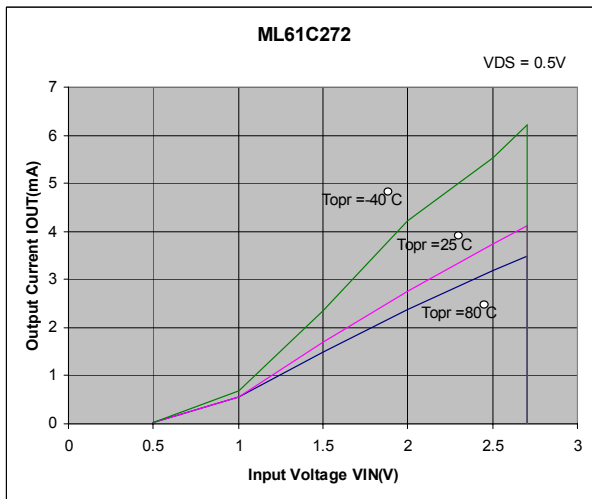

6) P-ch Driver Output Current vs. Input Voltage

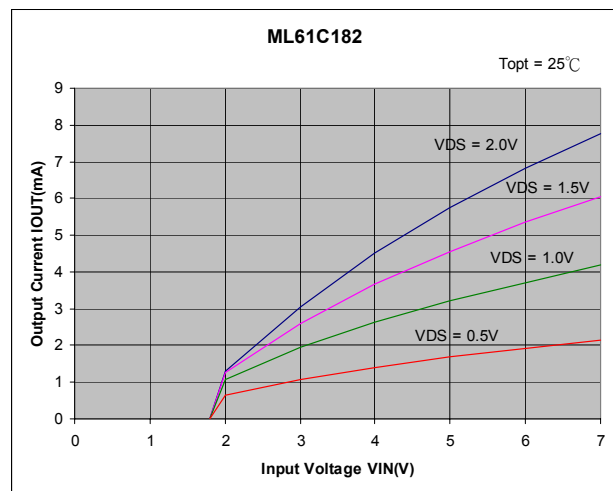
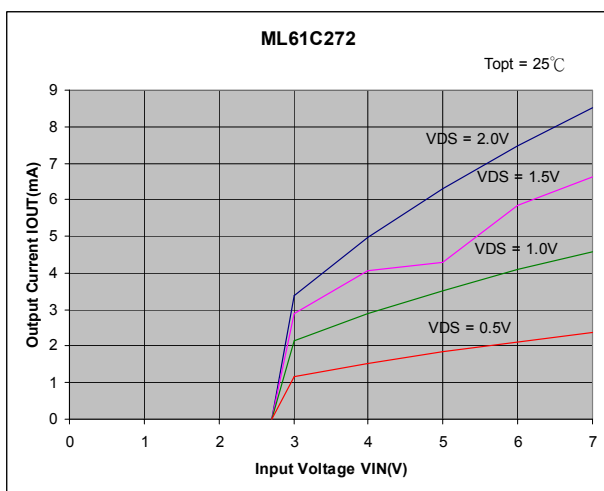

❖ **Ordering Information**

Designator	Description
a	Output Configuration C = CMOS Output N = N-Channel Output
b	Detect Voltage eg. 30=3.0V 50=5.0V
c	Detect Voltage Accuracy 2 = ±2.0% 3 = ±3.0%
d	Package Type M = SOT-23 P = SOT-89 T = TO-92
e	Device Orientation R = Embossed Tape (Orientation of Device : Right) L = Embossed Tape (Orientation of Device : Left) B = Bag (TO-92) H = Paper Tape (TO-92)

ML61xxxxxx
↑ ↑ ↑ ↑ ↑
a b c d e

❖ **Marking**

SOT-23 :

Designator	Description
1	Type C = Voltage Detector (CMOS Output) N = Voltage Detector (N-channel Output)
2,3	Output Voltage eg. 30 = 3.0V
4	Internal Code

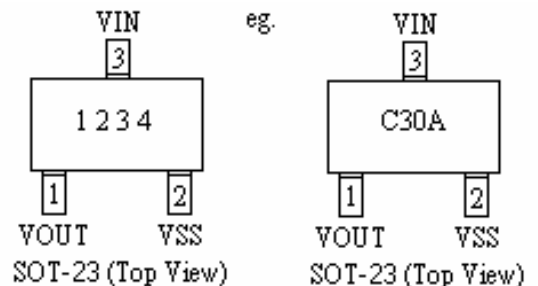

SOT-89 :

Designator	Description
1	Type C = Voltage Detector (CMOS Output) N = Voltage Detector (N-channel Output)
2,3	Output Voltage eg. 30 = 3.0V
4	Internal Code

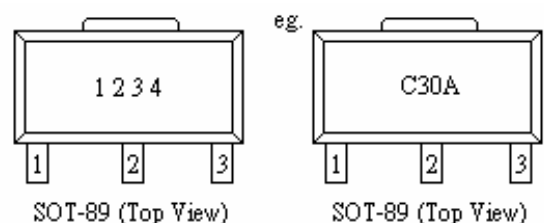

TO-92 :

Designator	Description
1	Type C = Voltage Detector (CMOS Output) N = Voltage Detector (N-channel Output)
2,3	Output Voltage eg. 30 = 3.0V
4	Internal code
5, 6	Year Code eg. 00 = Year 2000
7, 8	Week Code eg. 10 = Week 10

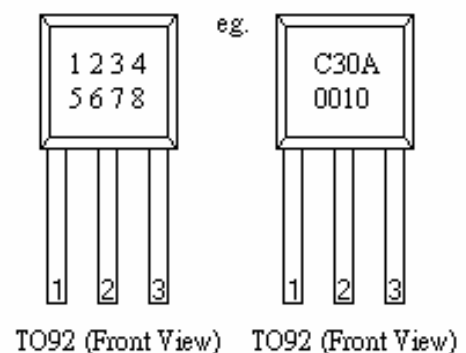

❖ **Packaging Information**

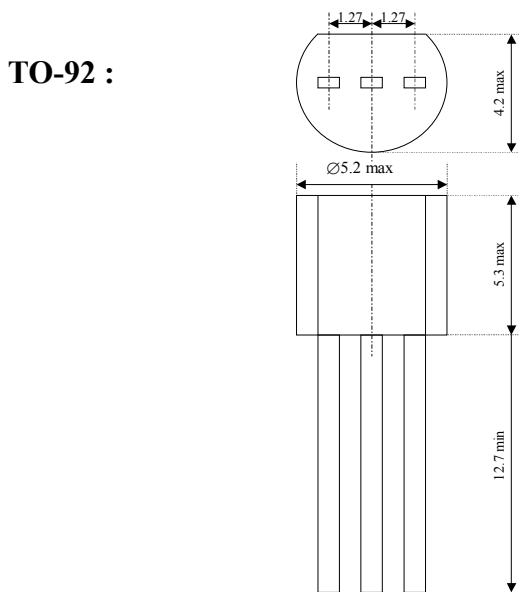
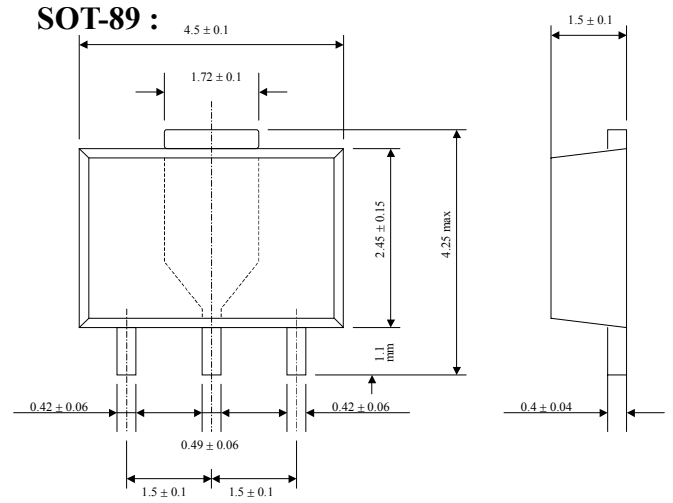
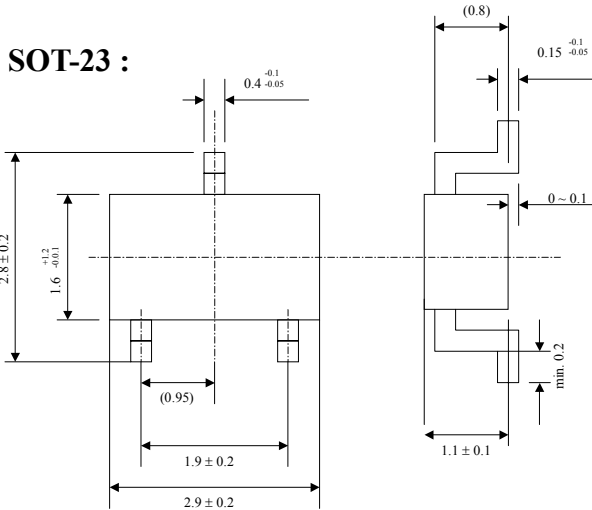

Units : mm

❖ **Recommended Pattern Layout**

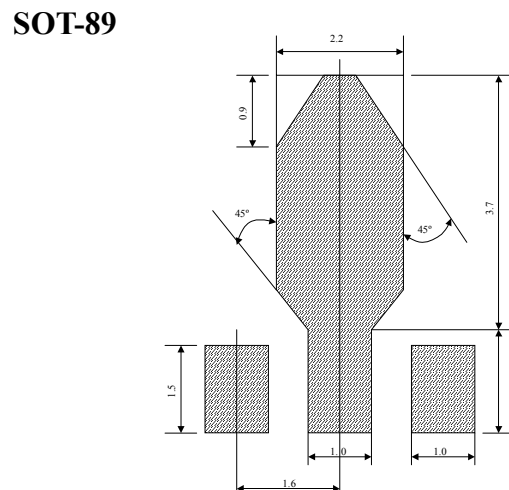
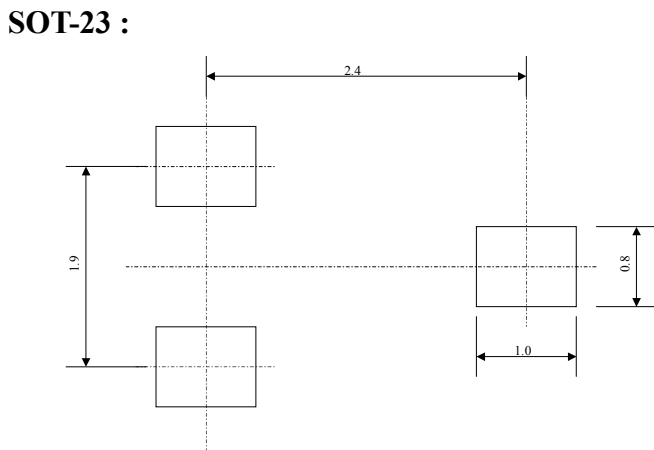

❖ **Tape and Reel Information**

SOT-23 :

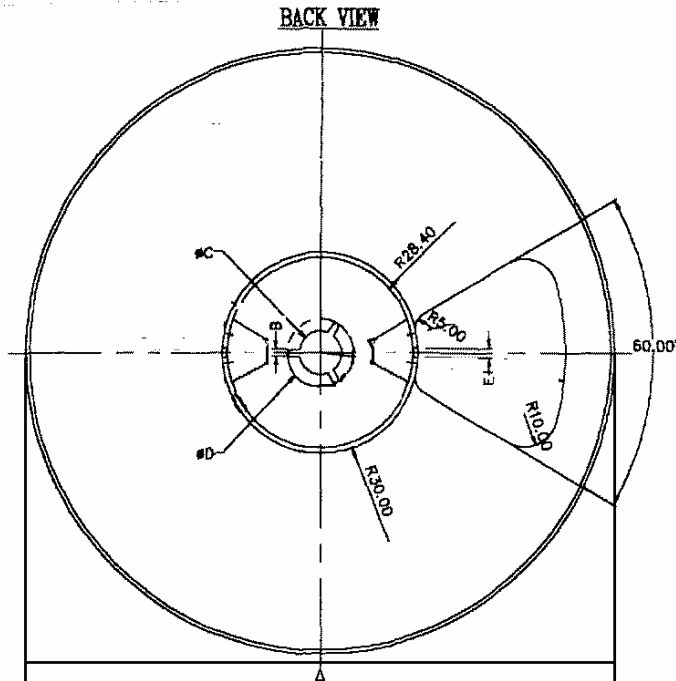
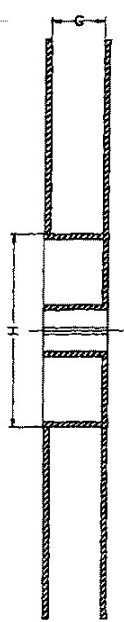

	SIZE (mm)
A	∅ 178 ± 0.8
B	2 ± 0.2
C	∅ 13 ± 0.2
D	∅ 21 ± 0.8
G	8 ± 0.5
H	∅ 60

3,000 pcs / reel

SOT-23 Taping Specifications :

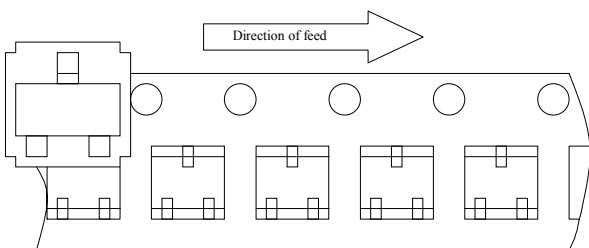
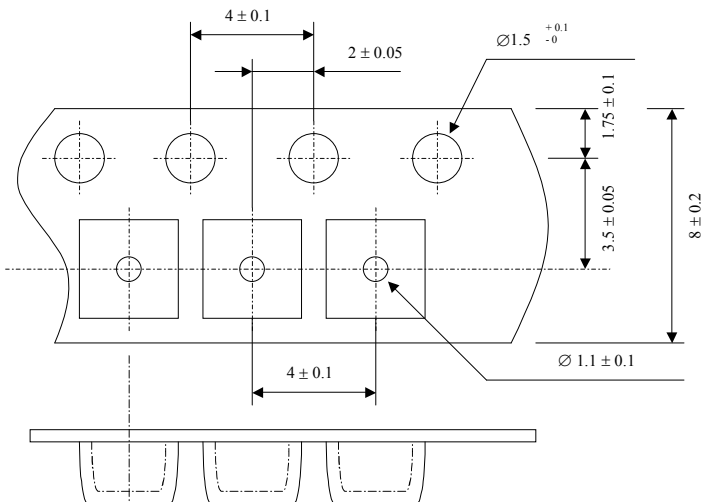

“R” type [Orientation of Device: Right]
Standard Type

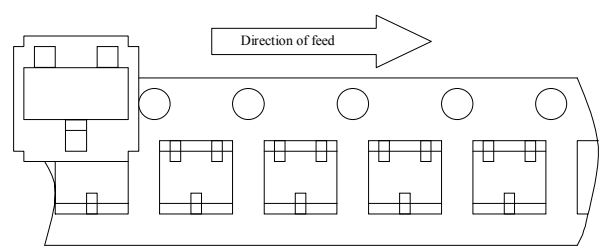

“L” type [Orientation of Device: Left]
Reverse Type

SOT-89 :

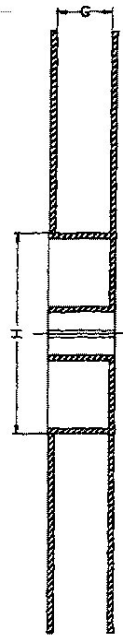
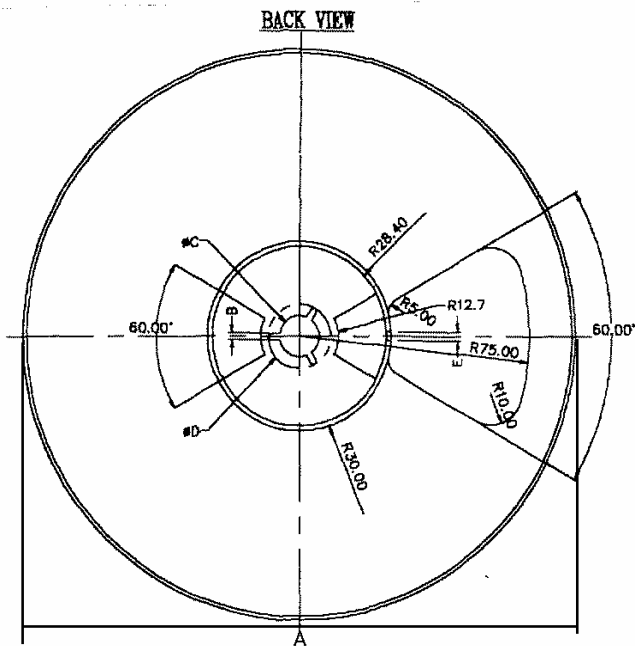

	SIZE (mm)
A	∅ 178 ± 0.8
B	2 ± 0.2
C	∅ 13 ± 0.2
D	∅ 21 ± 0.8
G	12 ± 0.5
H	∅ 60

1,000 pcs / reel

SOT-89 Taping Specifications :

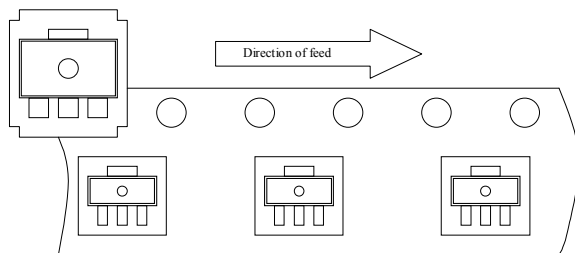
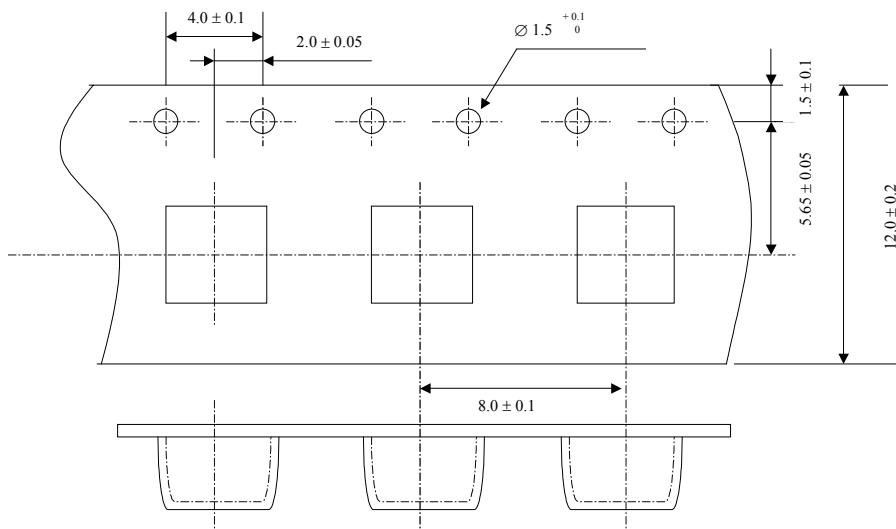

"R" type [Orientation of Device: Right]
Standard Type

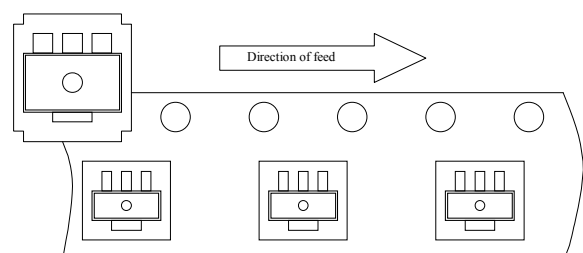

"L" type [Orientation of Device: Left]
Reverse Type

TO-92 Taping Specifications :

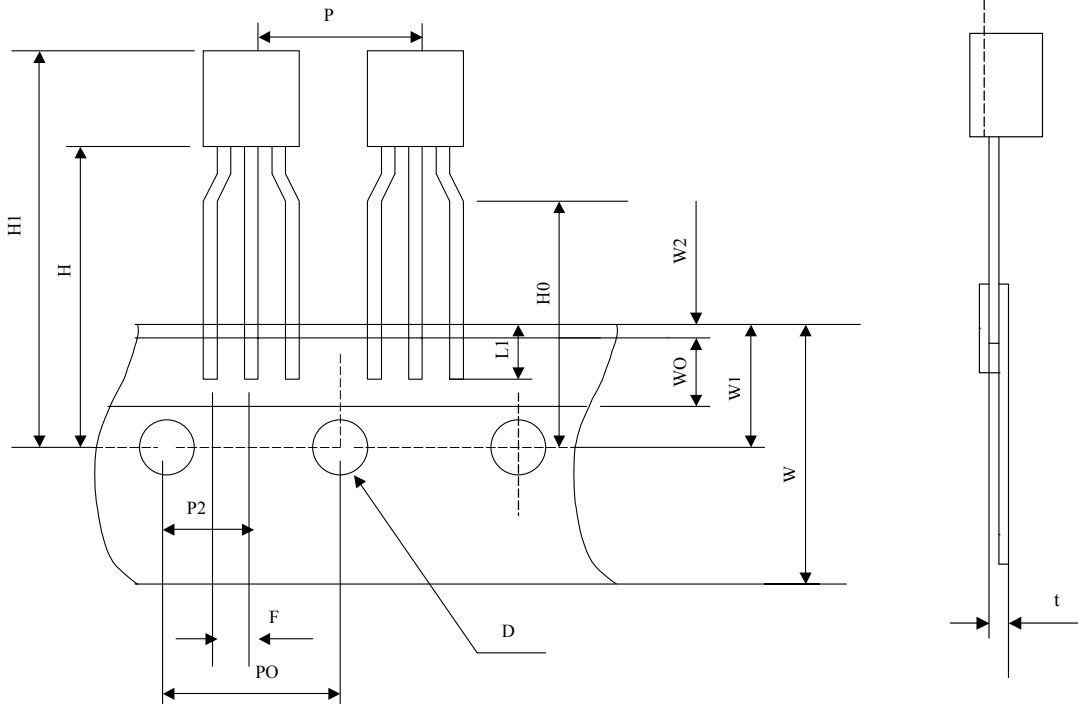

2,000 pcs / box

	SIZE (mm)
P	12.7 ± 1.0
PO	12.7 ± 0.3
P2	6.35 ± 0.4
F	2.5 ^{+0.45} _{-0.15}
W	18.0 ± 1.0
W0	6.0 ± 0.3
W1	9.0 ± 0.5
W2	0.5 MAX
H	19.0 ± 0.5
H0	16.0 ± 0.5
H1	32.25 MAX
D	∅ 4.0 ± 0.2
t	0.6 ± 0.2
L1	3.5 MIN

❖ *History of Revision*

REV	DESCRIPTION	DATE
	First Official Specification	20/3/02
A	Modify Max. Output Current & Add Table of Electrical characteristics by Detector Threshold.	3/4/02
B	Maximum Input Voltage increased to 12V, Hysteresis Range modified to 2% to 7% & Typical Performance Characteristics	31/10/02
C	Absolute Maximum Input Rating of Input Voltage reduced from 12V to 10V.	3/9/04

The information presented in this document does not form part of any quotation or contract, is believed to be accurate and reliable and may be changed without notice. No liability will be accepted by the publisher for any consequence of its use.