

TFT COLOR LCD MODULE
NL3224AC35-10

14 cm (5.5 inches), 320 × 240 Pixels, Full color
Incorporated backlight with inverter

NL3224AC35-10 is a TFT (thin film transistor) active matrix color liquid crystal display (LCD) comprising amorphous silicon TFT attached to each signal electrode, a driving circuit and a backlight. NL3224AC35-10 has a built-in backlight.

The 14 cm diagonal display area contains 320 × 240 pixels and can display full-color (more than 16 million colors) simultaneously.

FEATURES

- High luminance
- Analog RGB interface
- Reversible horizontal and vertical scanning
- Incorporated edge type backlight with Inverter
- Smooth polarizer surface

APPLICATIONS

- TV monitors
- Video games
- Monitors for process controller



STRUCTURE AND FUNCTIONS

A color TFT (thin film transistor) LCD module is comprised of a TFT liquid crystal panel structure, LSIs for driving the TFT array, and a backlight assembly. The TFT panel structure is created by sandwiching liquid crystal material in the narrow gap between a TFT array glass substrate and a color filter glass substrate. After the driver LSIs are connected to the panel, the backlight assembly is attached to the backside of the panel.

RGB (red, green, blue) data signals from a source system is modulated into a form suitable for active matrix addressing by the onboard signal processor and sent to the driver LSIs which in turn addresses the individual TFT cells.

Acting as an Electro-optical switch, each TFT cell regulates light transmission from the backlight assembly when activated by the data source. By regulating the amount of light passing through the array of red, green, and blue dots, color images are created with clarity.

OUTLINE OF CHARACTERISTICS (at room temperature)

Display area	111.36 (H) × 83.52 (V) mm
Drive system	a-Si TFT active matrix
Display colors	Full-color
Number of pixels	320 × 240
Pixel arrangement	RGB vertical stripe
Pixel pitch	0.348 (H) × 0.348 (V) mm
Module size	134.0 (H) × 110.0 (V) × 23.0 max. (D) mm
Weight	330 g (typ.)
Contrast ratio	85:1 (typ.)
Viewing angle (more than the contrast ratio of 10:1)	
• Horizontal: 50° (typ. left side, right side)	
• Vertical: 25° (typ. up side), 25° (typ. down side)	
Designed viewing direction	
• wider viewing angle with contrast ratio	: down side (6 o'clock)
• wider viewing angle without image reversal	: up side (2 and 10 o'clock)
• optimum grayscale ($\gamma = 2.2$)	: perpendicular
Polarizer Pencil-hardness	2H (min. at JIS K-5400)
Color gamut	50 % (typ. center, to NTSC)
Response time	16 ms (typ.), "white" to "black"
Luminance	250 cd/m ² (typ.)
Signal system	Analog RGB signals, synchronous signals (Hsync and Vsync), CLK
Supply voltage	12 V, 12 V (Logic/LCD driving, Backlight)
Backlight	Edge light type: one cold cathode fluorescent lamp
Power consumption	6.5 W (typ.)

BLOCK DIAGRAM

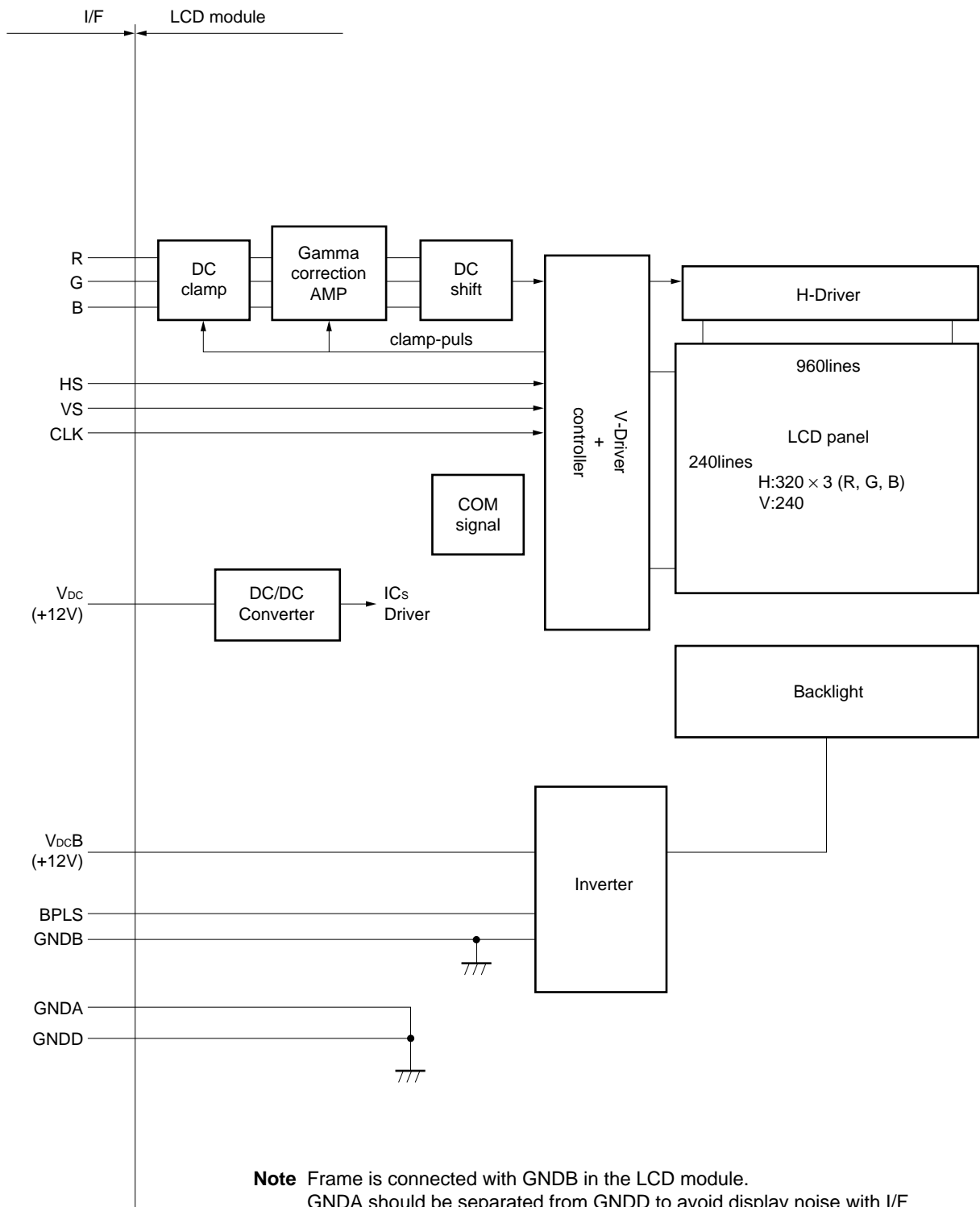

Note Frame is connected with GNDDB in the LCD module.
 GNDA should be separated from GNDD to avoid display noise with I/F connection.

GENERAL SPECIFICATIONS

Item	Specifications	Unit
Module size	134.0±0.5 (H) × 110.0±0.5 (V) × 23.0 max. (D)	mm
Display area	111.36 (H) × 83.52 (V)	mm
Number of dots	320 × 3 (H) × 240 (V)	dot
Dot pitch	0.116 (H) × 0.348 (V)	mm
Pixel pitch	0.348 (H) × 0.348 (V)	mm
Pixel arrangement	RGB (Red, Green, Blue) vertical stripe	–
Display colors	Full-color	color
Weight	335 (max.)	g

ABSOLUTE MAXIMUM RATINGS

Parameter	Symbol	Ratings	Unit	Remarks
Supply voltage	V _{DC}	–0.5 to 16.0	V	Ta = –20 to 65 °C
	V _{DCB}	–0.5 to 16.0	V	
Logic input voltage	V _{IN1}	–0.5 to 5.5	V	Ta = –20 to 65 °C
Analog RGB input signal	V _{IN2}	–2.5 to 2.5	V	V _{DC} = 12 V
Storage temp.	T _{ST}	–20 to 65	°C	–
Operating temp.	T _{OP}	0 to 65	°C	Module surface*
Humidity (no condensation)		≤ 90 % relative humidity		Ta ≤ 60 °C

* measured at the center of the display area

ELECTRICAL CHARACTERISTICS

(1) Power supply, logic input

Ta = 25 °C

Parameter	Symbol	min.	typ.	max.	Unit	Remarks
Supply voltage	V _{DC}	11.0	12.0	13.0	V	For Logic and LCD driving
	V _{DCB}	11.0	12.0	13.0	V	For backlight
Logic input “L” voltage	V _{IL}	0	–	0.9	V	–
Logic input “H” voltage	V _{IH}	3.15	–	5.0	V	
Supply current	I _{DC}	–	145	200	mA	At pixel-checked pattern (V _{DC} = 12.0 V)
	I _{DCB}	–	395	450	mA	Maximum luminance (V _{DCB} = 12.0 V)

(2) Video signal (R, G, B) input

Ta = 25 °C

Item	min.	typ.	max.	Unit	Remarks
Maximum amplitude (white - back)	0	–	0.7	Vp-p	–
DC input level (black)	–1.0	–	+1.0	V	

SUPPLY VOLTAGE SEQUENCE

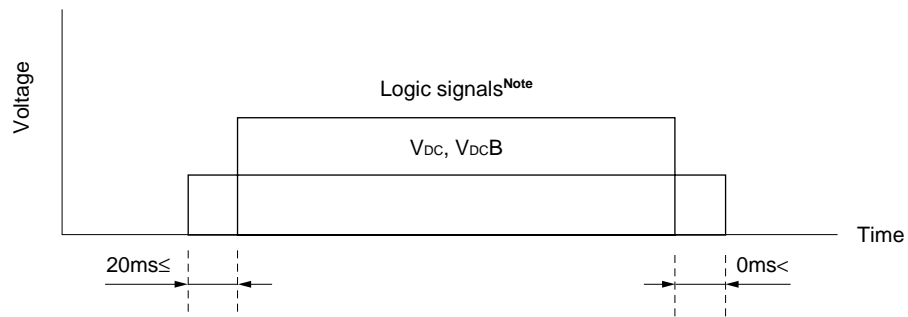

Note Synchronous signal, Control signals, CLK

CAUTION
Wrong power sequence may damage to the module.

- a) Logic signals (synchronous signals and control signals) should be “0” voltage (V), when V_{DC} is not input. If higher than 0.3 V is input to signal lines, the internal circuit will be damaged.
- b) The backlight power supply (V_{DCB}) is not related to the power supply sequence. However, unstable data will be displayed when the backlight power is turned ON with no logic signals.
- d) Analog RGB input are independent from this power supply sequence.
- f) Apply V_{DCB} within the LCD operation period. When the backlight turns on before LCD operation or the LCD operation turns off before the backlight turns off, the display may momentarily become white.

INTERFACE PIN CONNECTION

Connector (CN1)

- Part no. : 52610-2417
- Supplier : Molex
- Adaptable cable : SUMI-CARD 1.0 mm pitch 24 wick 80 °C quality
- Supplier : SUMITOMO ELECTRIC INDUSTRIES, LTD.

Pin No.	Symbol	Pin No.	Symbol	Pin No.	Symbol
1	GNDD	9	GNDD	17	GNDD
2	ECLK	10	U/D	18	GNDA
3	GNDD	11	GNDD	19	R
4	HS	12	V _{DC}	20	GNDA
5	VS	13	V _{DCB}	21	G
6	BPLS	14	V _{DCB}	22	GNDA
7	GNDD	15	GNDB	23	B
8	GNDD	16	GNDB	24	GNDA

<Connector location>

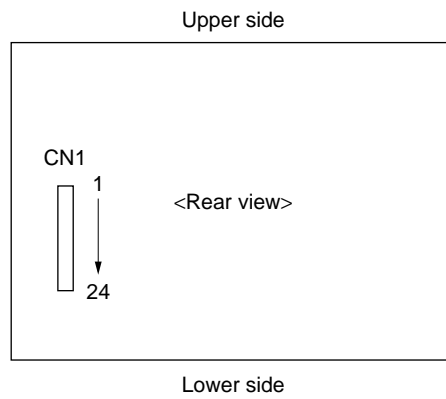

PIN FUNCTIONS

Symbol	I/O	Logic	Description
ECLK	Input	–	External clock input. (CMOS level) This timing-signal is for display data.
Hsync	Input	Negative	Horizontal synchronous signal input (CMOS level)
Vsync	Input	Negative	Vertical synchronous signal input (CMOS level)
R	Input	–	Analog Red signal input (0.7Vp-p, 75 Ω)
G	Input	–	Analog Green signal input (0.7Vp-p, 75 Ω)
B	Input	–	Analog Blue signal input (0.7Vp-p, 75 Ω)
U/D	Input	–	Scan direction select signal. Default value is H (CMOS level) H: down scanning L: up scanning
BPLS	Input	–	Luminance control signal (pulse input) Luminance is controlled by the pulse width
V _{bc}	Input	–	Power supply for processor, controller and driver (+12 V)
V _{bcB}	Input	–	Power supply for backlight (+12 V)
GNDA	–	–	Ground for analog RGB signal Note
GNDD	–	–	Ground for logic (V _{bc}) Note
GNDB	–	–	Ground for backlight. (V _{bcB})

Note GNDA should be separated from GNDD to avoid display noise.

INPUT SIGNAL TIMING

Parameter		Symbol	min.	typ.	max.	Unit	Remarks
External-CLK	Frequency	1/tc	– 118.75	8.0 125.00	– 131.25	MHz ns	–
	Rise/fall	tcrf	–	–	10	ns	–
	Duty	tch/tc	0.4	0.5	0.6	–	–
HS	Period	th	60.38 –	63.56 508	66.74 –	μs CLK	15.734 kHz (typ.)
	Display	thd	– –	40.00 320	– –	μs CLK	–
	Pulse-width	thp	1.0 –	4.7 38	– –	μs CLK	–
	Pulse-width +Back-porch	thpb	– –	9.63 77	– –	μs CLK	240 line
	CLK-Hsync timing hold/setup time	thch	10.0	–	–	ns	–
		thcs	10.0	–	–	ns	–
	V-Hsync timing hold/setup time	thvh	1.5	–	–	CLK	–
		thvs	10.0	–	–	CLK	–
	Rise/fall	thrf	–	–	10.0	ns	–
VS	Period	tv	15.85 –	16.68 262.5	17.51 –	ns	59.94 Hz (typ.)
	Display	tvd	– –	15.25 240	– –	ms H	240 line
	Pulse-width	tvp	158.89 –	190.67 3	– –	μs H	–
	Pulse-width +Back-porch	tvpb	– –	1.33 21	– –	ms H	–
	Rise/fall	tvrf	–	–	10.0	ns	–
Analog R, G, B	Setup time	tdas	10.0	–	–	ns	–
	Hold time	tdah	10.0	–	–	ns	–

Note In the display start period (pulse-width + back-porch), analog RGB signals should be blanking level.

DEFINITION OF INPUT SIGNAL TIMING

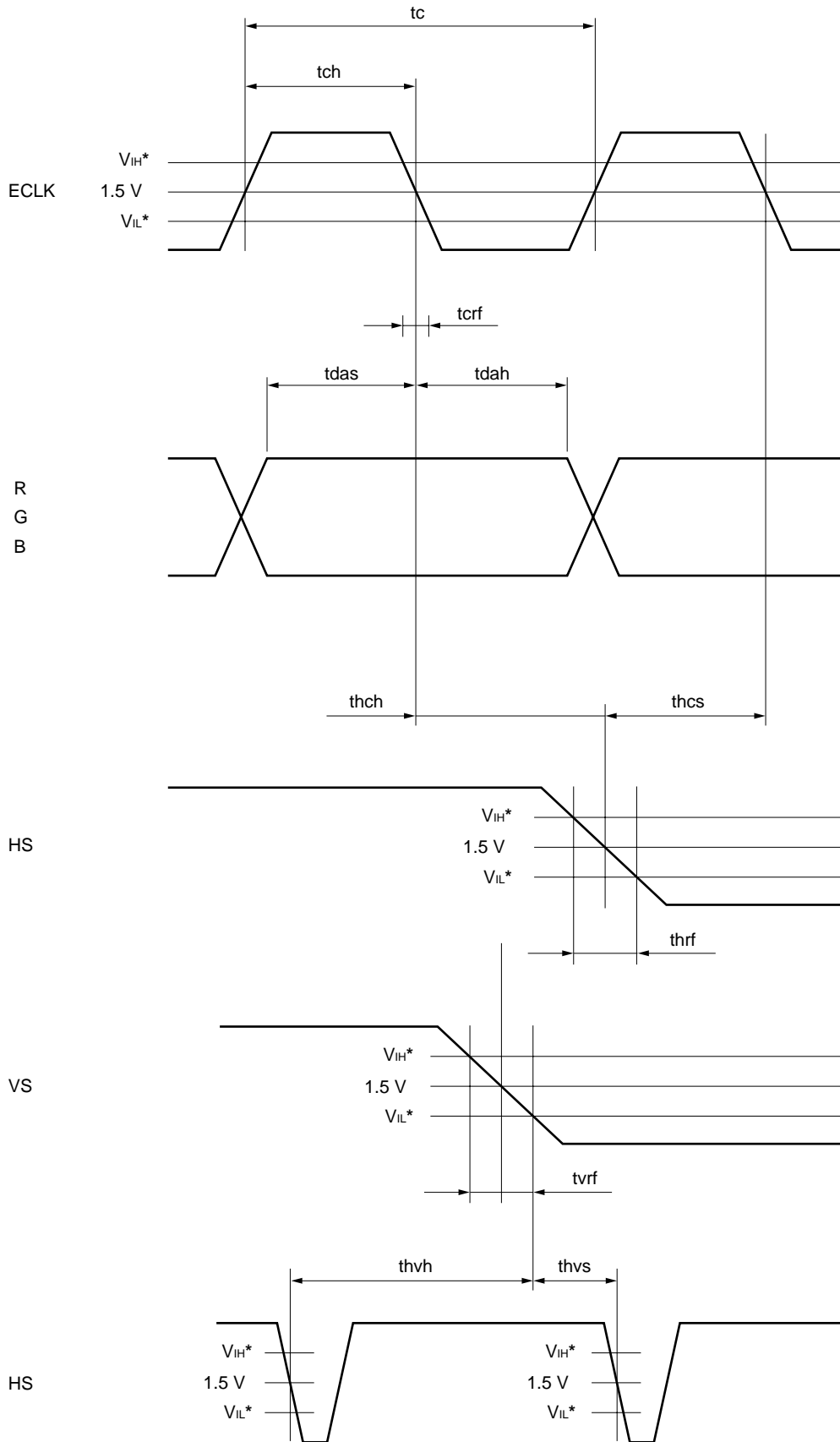

* $V_{IH} = 3.15 \text{ V (min.) to } 5.00 \text{ V (max.)}$
 $V_{IL} = 0.00 \text{ V (min.) to } 0.90 \text{ V (max.)}$

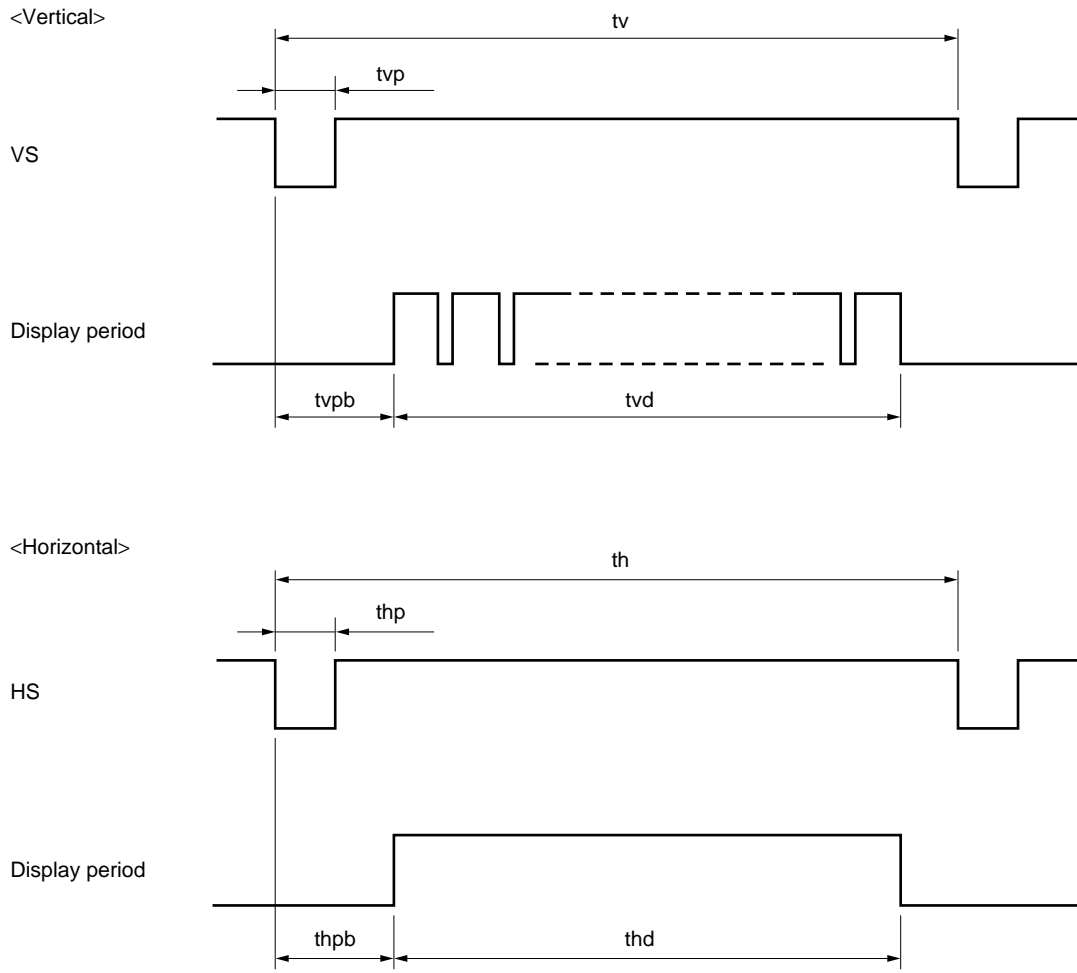

Note Refer to OPTICAL CHARACTERISTICS Note 6 about BPLS.

OPTICAL CHARACTERISTICS

(Ta = 25 °C, VDD = 12 V, VDDb = 12 V) **Note 1**

Item	Symbol	Condition	Min.	Typ.	Max.	Unit	Remark
Luminance	Lvmax	White	200	250	–	cd/m ²	Note 1
Contrast ratio	CR	Perpendicular	70	85	–	–	Note 2
Luminance control range	–	max. = 100 %	10	–	100	–	Note 6

Reference data

(Ta = 25 °C, VDD = 12 V, VDDb = 12 V)

Item	Symbol	Condition	Min.	Typ.	Max.	Unit	Remark
Contrast ratio	CR	$\theta R = 0^\circ, \theta L = 0^\circ, \theta U = 0^\circ, \theta D = 5^\circ$	80	100	–	–	Note 2
Color gamut	C	at center, to NTSC	40	50	–	–	–
Luminance uniformity	–	White	–	–	2.0	–	Note 3
Viewing angle range	θR	CR > 10, $\theta U = 0^\circ, \theta D = 5^\circ$	45	50	–	deg.	Note 4
	θL	white/black	45	50	–	deg.	
	θU	CR > 10, $\theta R = 30^\circ, \theta L = 30^\circ$	18	25	–	deg.	
	θD	white/black	18	25	–	deg.	
Response time	Ton	white to black	–	16	30	ms	Note 5
	Toff	black to white	–	44	60	ms	Note 5

- Notes 1.** The luminance is measured after 20 minutes from the module works, with all pixels in “white”. The typical value is measured after luminance saturation.
- 2.** The contrast ratio is calculated by using the following formula.

$$\text{Contrast ratio (CR)} = \frac{\text{Luminance with all pixels in "white"}}{\text{Luminance with all pixels in "black"}}$$

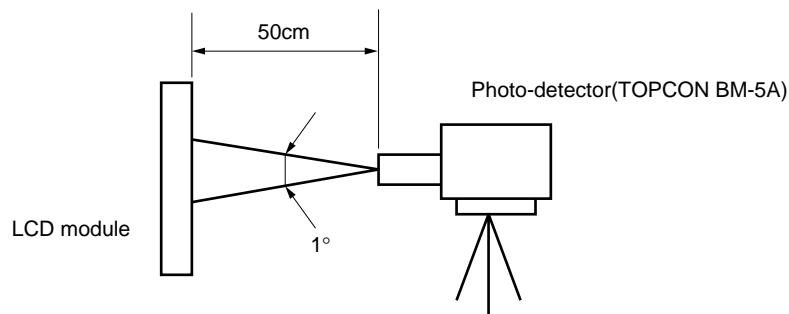

- 3.** Luminance uniformity is calculated by using the following formula.

$$\text{Luminance uniformity} = \frac{\text{Minimum Luminance}}{\text{Maximum Luminance}}$$

The luminance is measured at near the five points shown below.

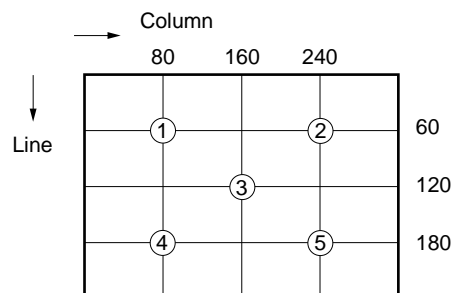

Notes 4. Definitions of viewing angle are as follows.

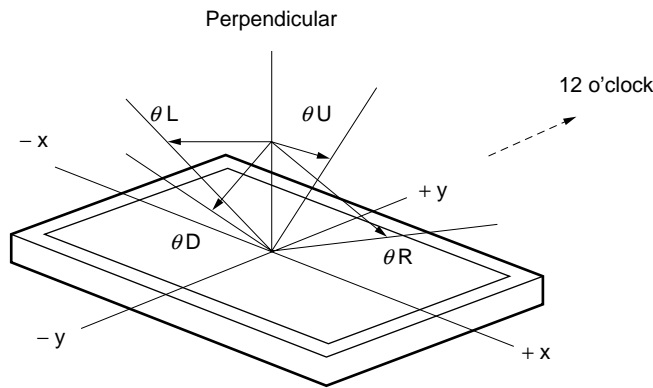

5. Definitions of response time is as follows.

Photo-detector output signal is measured when the luminance changes "white" to "black" and "black" to "white". Response time are T_{on} and T_{off} of the photo-detector output amplitude. T_{on} is the time between 100 % and 10 %. T_{off} is the time between 0 % and 90 %.

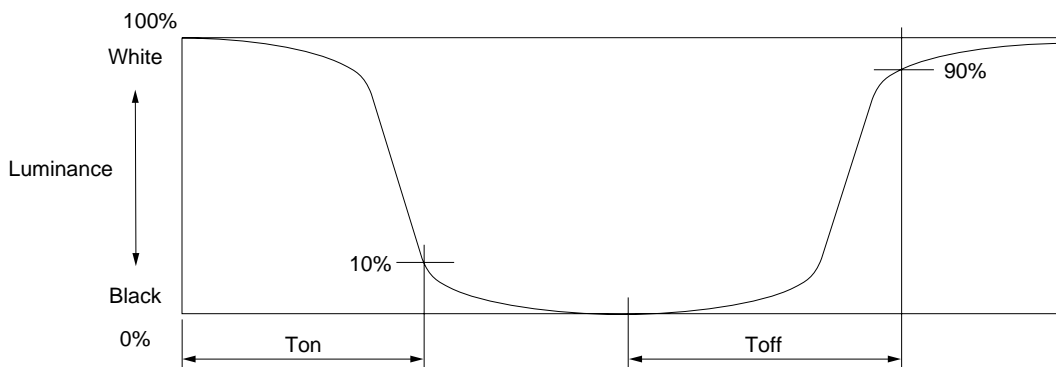

6. The pulse signal for luminous control needs to feed BPLS-pin in the white-color data. (CMOS level)

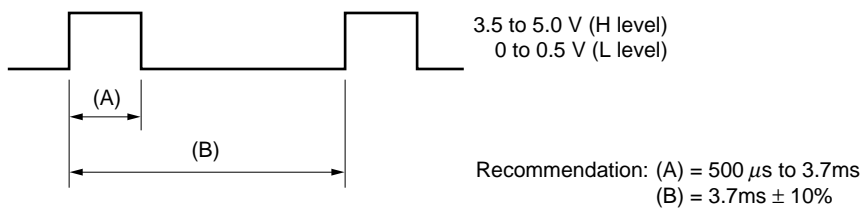

Pulse (A) duty 100 %: Relative luminance is 100 %
 Pulse (A) duty 20 %: Relative luminance is 10 % (reference value)

RELIABILITY TEST

Test item	Test condition	Judgment
High temperature (operation)	① 65±2 °C at the display aria ② 192 hours ③ Others are based on JASO-D001.	*1
Low temperature (operation)	① 0±4 °C at the display aria ② 192 hours ③ Others are based on JASO-D001.	*1
High temperature (non-operation)	① 65±2 °C at the display aria ② 192 hours ③ Others are based on JASO-D001.	*1
Low temperature (non-operation)	① -20±4 °C at the display aria ② 192 hours ③ Others are based on JASO-D001.	*1
High temperature/humidity (operation)	① 60±2 °C, 90 % relative humidity ② 192 hours ③ Others are based on JASO-D001.	*1
Thermal shock (non-operation)	① First step : 65±3 °C, 30 minutes Second step : -20±3 °C, 30 minutes ② 100 cycles ③ Others are based on JASO-D001.	*1
Vibration (non-operation)	① 5-200 Hz, 3G ② 10 minute/sweep, ③ X and Y direction : 2 hours Z direction : 4 hours ④ Others are based on JASO-D001.	*1, *2
Mechanical shock (non-operation)	① 100G, 11ms ② X, Y, Z direction: 3 times each direction ③ Others are based on JASO-D001.	*1, *2
ESD (operation)	① 150 pF, 150 Ω, ±10 KV ② 9 places on a panel *3 ③ 10 times each place at one-second intervals	*1

JASO: Japanese Automobile Standards Organization

*1: Display function is checked by the same condition as LCD module out-going inspection.

*2: Physical damage

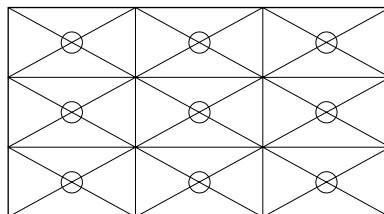

*3: Discharge points are shown in the figure.



GENERAL CAUTIONS

Next figures and sentence are very important. Please understand these contents as follows.

	CAUTION	This figure is a mark that you will get hurt and/or the module will have damages when you make a mistake to operate.
---	----------------	--

	This figure is a mark that you will get an electric shock when you make a mistake to operate.	
	This figure is a mark that you will get hurt when you make a mistake to operate	

 **CAUTION**

	Do not touch an inverter, on which is stuck a caution label, while the LCD module is under the operation, because of dangerous high voltage.
---	--

- (1) Caution when taking out the module
 - a) Pick the pouch only, in taking out module from a carrier box.

- (2) Cautions for handling the module
 - a) As the electrostatic discharges may break the LCD module, handle the LCD module with care against electrostatic discharges.
 - b)  As the LCD panel and backlight element are made from fragile glass material, impulse and pressure to the LCD module should be avoided.
 - c) As the surface of polarizer is very soft and easily scratched, use a soft dry cloth without chemicals for cleaning.
 - d) Do not pull the interface connectors in or out while the LCD module is operating.
 - e) Put the module display side down on a flat horizontal plane.
 - f) Handle connectors and cables with care.
 - g) When the module is operating, do not lose ECLK, Hsync, or Vsync signal. If any one of these signals is lost, the LCD panel would be damaged.
 - h) Don't push or rub the surface of LCD module please.
If you do, the scratches or the marks like rubbing may left on the surface of the module.

- (3) Cautions for the atmosphere
 - a) Dew drop atmosphere must be avoided.
 - b) Do not store and/or operate the LCD module in a high temperature and/or high humidity atmosphere. Storage in an Electro-conductive Polymer Packing Pouch and under relatively low temperature atmosphere is recommended.
 - c) This module uses a cold cathode fluorescent lamp. Therefore, the life time of the lamp becomes short conspicuously at low temperature.
 - d) Do not operate the LCD module in a high magnetic field.

- (4) Caution for the module characteristics
 - a) Do not apply the fixed pattern data signal to the LCD module at product aging. Applying fixed pattern for a long time may cause image sticking.
 - b) The noise from the inverter circuit may be observed in the luminance control mode. This is not defects not malfunctions.

(5) Other cautions

- a) Do not disassemble and/or reassemble LCD module.
- b) Do not readjust variable resistors nor switches etc.
- c) When returning the module for repair or etc., please pack the module not to be broken. We recommend the original shipping packages.

Liquid Crystal Display has the following specific characteristics. There are not defects or malfunctions.

The display condition of LCD module may be affected by the ambient temperature.

This module has cold cathode tube for backlight. Optical characteristics, like luminance or uniformity, will be changed during time.

Uneven brightness and/or small spots may be noticed depending on different display patterns.

OUTLINE DRAWING (Unit in mm) Front view

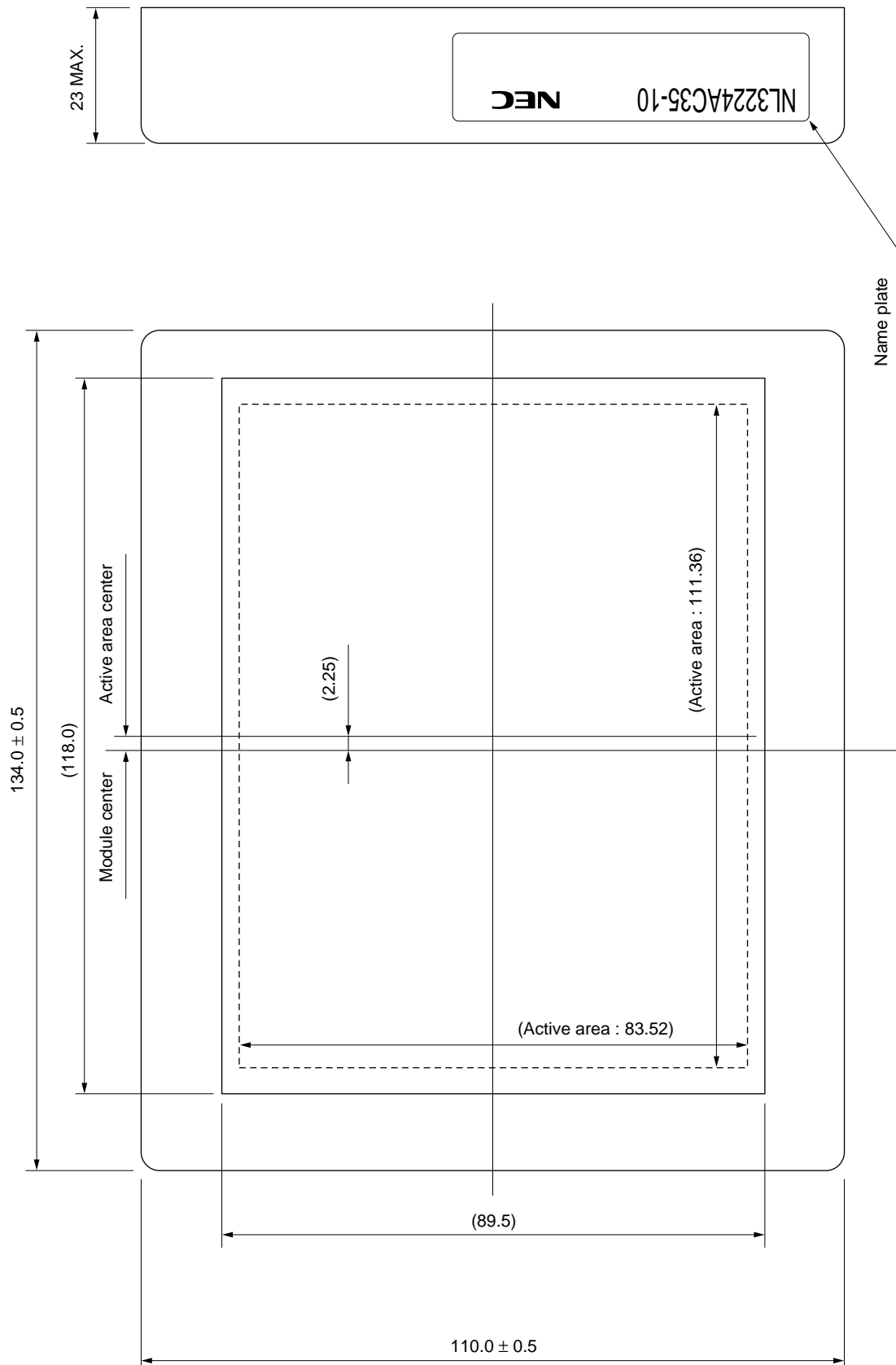

OUTLINE DRAWING (Unit in mm) Rear view

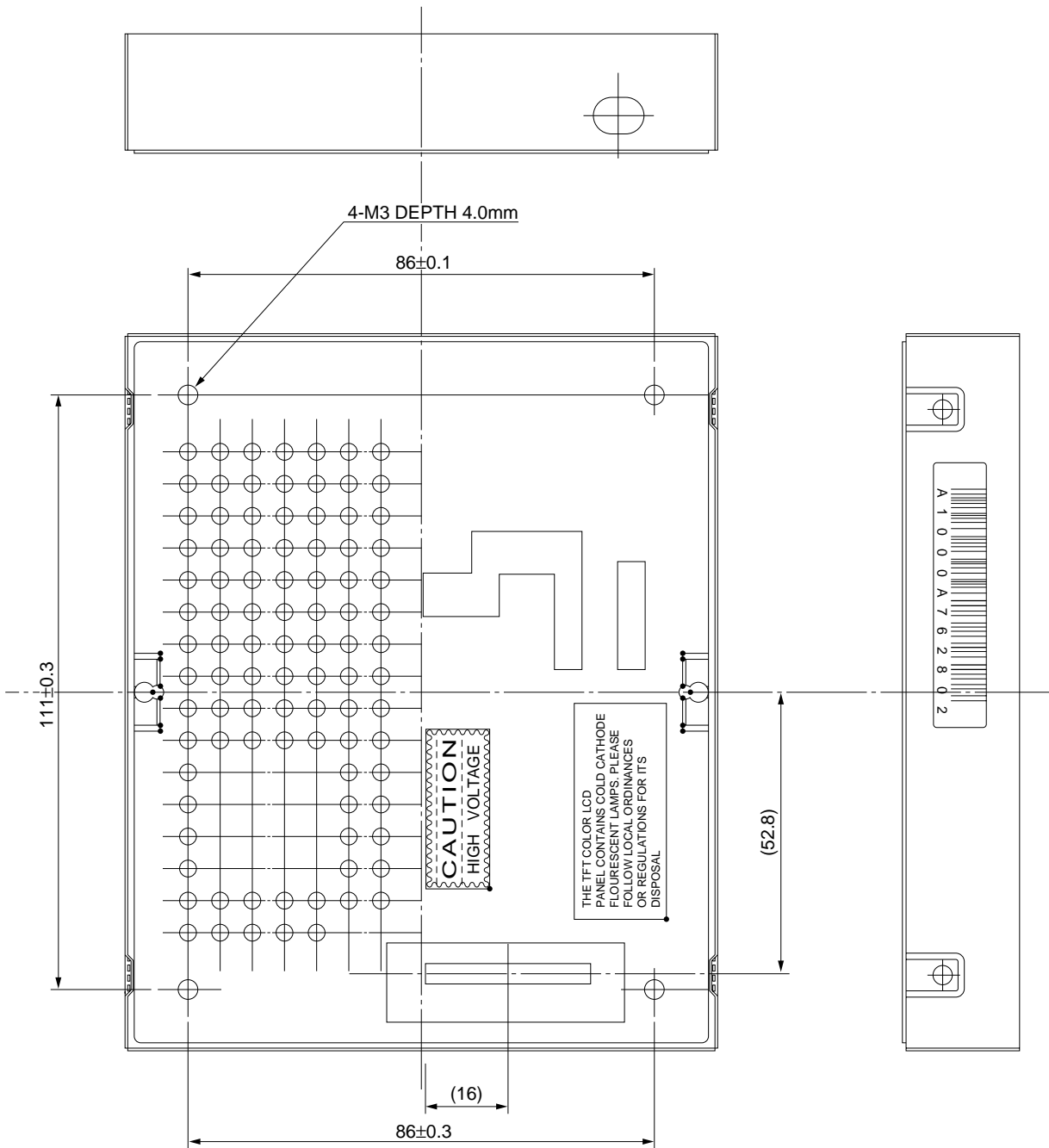

[MEMO]

[MEMO]

No part of this document may be copied or reproduced in any form or by any means without the prior written consent of NEC Corporation. NEC Corporation assumes no responsibility for any errors which may appear in this document.

NEC Corporation does not assume any liability for infringement of patents. Copyrights or other intellectual property rights of third parties by or arising from use of a device described herein or any other liability arising from use of such device. No license, either express, implied or otherwise, is granted under any patents, copyrights or other intellectual property rights of NEC Corporation or others.

While NEC Corporation has been making continuous effort to enhance the reliability of its Electronic components, the possibility of defects cannot be eliminated entirely. To minimize risks of damage or injury to persons or property arising from a defect in an NEC electronic components, customers must incorporate sufficient safety measures in its design, such as redundancy, fire-containment, and anti-failure features.

NEC devices are classified into the following three quality grades:

"Standard", "Special", and "Specific". The Specific quality grade applies only to devices developed based on a customer designated "quality assurance program" for a specific application. The recommended applications of a device depend on its quality grade, as indicated below. Customers must check the quality grade of each device before using it in a particular application.

Standard: Computers, office equipment, communications equipment, test and measurement equipment, audio and visual equipment, home electronic appliances, machine tools, personal electronic equipment and industrial robots

Special: Transportation equipment (automobiles, trains, ships, etc.), traffic control systems, anti-disaster systems, anti-crime systems, safety equipment and medical equipment (not specifically designed for life support)

Specific: Aircrafts, aerospace equipment, submersible repeaters, nuclear reactor control systems, life support systems or medical equipment for life support, etc.

The quality grade of NEC devices is "Standard" unless otherwise specified in NEC's Data Sheets or Data Books.

If customers intend to use NEC devices for applications other than those specified for Standard quality grade, they should contact an NEC sales representative in advance.

Anti-radioactive design is not implemented in this product.