

**Full - Bridge  
MOSFET Power Module**

**$V_{DSS} = 500V$**   
 **$R_{DSon} = 100m\Omega \text{ max @ } T_j = 25^\circ C$**   
 **$I_D = 37A \text{ @ } T_c = 25^\circ C$**

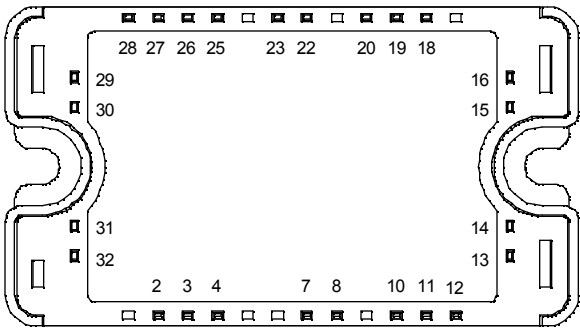
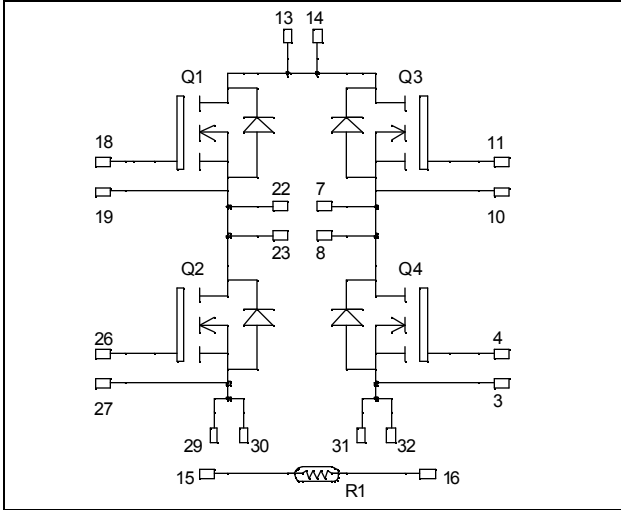

All multiple inputs and outputs must be shorted together  
 Example: 13/14 ; 29/30 ; 22/23 ...

**Application**

- Welding converters
- Switched Mode Power Supplies
- Uninterruptible Power Supplies

**Features**

- Power MOS 7<sup>®</sup> FREDFETs
  - Low  $R_{DSon}$
  - Low input and Miller capacitance
  - Low gate charge
  - Fast intrinsic reverse diode
  - Avalanche energy rated
  - Very rugged
- Kelvin source for easy drive
- Very low stray inductance
  - Symmetrical design
- Internal thermistor for temperature monitoring
- High level of integration

**Benefits**

- Outstanding performance at high frequency operation
- Direct mounting to heatsink (isolated package)
- Low junction to case thermal resistance
- Solderable terminals both for power and signal for easy PCB mounting
- Low profile
- Each leg can be easily paralleled to achieve a phase leg of twice the current capability

**Absolute maximum ratings**

Symbol	Parameter	Max ratings	Unit
$V_{DSS}$	Drain - Source Breakdown Voltage	500	V
$I_D$	Continuous Drain Current	$T_c = 25^\circ C$	37
		$T_c = 80^\circ C$	28
$I_{DM}$	Pulsed Drain current	140	A
$V_{GS}$	Gate - Source Voltage	$\pm 30$	V
$R_{DSon}$	Drain - Source ON Resistance	100	$m\Omega$
$P_D$	Maximum Power Dissipation	$T_c = 25^\circ C$	312
$I_{AR}$	Avalanche current (repetitive and non repetitive)	41	A
$E_{AR}$	Repetitive Avalanche Energy	50	mJ
$E_{AS}$	Single Pulse Avalanche Energy	1600	

**CAUTION:** These Devices are sensitive to Electrostatic Discharge. Proper Handling Procedures Should Be Followed.

All ratings @  $T_j = 25^\circ\text{C}$  unless otherwise specified

## Electrical Characteristics

Symbol	Characteristic	Test Conditions	Min	Typ	Max	Unit	
$I_{DSS}$	Zero Gate Voltage Drain Current	$V_{GS} = 0\text{V}$ $V_{DS} = 500\text{V}$	$T_j = 25^\circ\text{C}$			100	$\mu\text{A}$
			$T_j = 125^\circ\text{C}$			500	
$R_{DS(on)}$	Drain – Source on Resistance	$V_{GS} = 10\text{V}, I_D = 18.5\text{A}$			100	$\text{m}\Omega$	
$V_{GS(th)}$	Gate Threshold Voltage	$V_{GS} = V_{DS}, I_D = 1\text{mA}$	3		5	V	
$I_{GSS}$	Gate – Source Leakage Current	$V_{GS} = \pm 30\text{V}, V_{DS} = 0\text{V}$			$\pm 100$	nA	

## Dynamic Characteristics

Symbol	Characteristic	Test Conditions	Min	Typ	Max	Unit
$C_{iss}$	Input Capacitance	$V_{GS} = 0\text{V}$ $V_{DS} = 25\text{V}$ $f = 1\text{MHz}$		4367		pF
$C_{oss}$	Output Capacitance			894		
$C_{rss}$	Reverse Transfer Capacitance			61		
$Q_g$	Total gate Charge	$V_{GS} = 10\text{V}$ $V_{Bus} = 250\text{V}$ $I_D = 37\text{A}$		96		nC
$Q_{gs}$	Gate – Source Charge			24		
$Q_{gd}$	Gate – Drain Charge			49		
$T_{d(on)}$	Turn-on Delay Time	<b>Inductive switching @ <math>125^\circ\text{C}</math></b> $V_{GS} = 15\text{V}$ $V_{Bus} = 333\text{V}$ $I_D = 37\text{A}$ $R_G = 5\Omega$		15		ns
$T_r$	Rise Time			21		
$T_{d(off)}$	Turn-off Delay Time			73		
$T_f$	Fall Time			52		
$E_{on}$	Turn-on Switching Energy ❶	<b>Inductive switching @ <math>25^\circ\text{C}</math></b> $V_{GS} = 15\text{V}, V_{Bus} = 333\text{V}$ $I_D = 37\text{A}, R_G = 5\Omega$		566		$\mu\text{J}$
$E_{off}$	Turn-off Switching Energy ❷			545		
$E_{on}$	Turn-on Switching Energy ❶	<b>Inductive switching @ <math>125^\circ\text{C}</math></b> $V_{GS} = 15\text{V}, V_{Bus} = 333\text{V}$ $I_D = 37\text{A}, R_G = 5\Omega$		931		$\mu\text{J}$
$E_{off}$	Turn-off Switching Energy ❷			635		

## Source - Drain diode ratings and characteristics

Symbol	Characteristic	Test Conditions	Min	Typ	Max	Unit	
$I_S$	Continuous Source current (Body diode)		$T_c = 25^\circ\text{C}$		37	A	
			$T_c = 80^\circ\text{C}$		28		
$V_{SD}$	Diode Forward Voltage	$V_{GS} = 0\text{V}, I_S = -37\text{A}$			1.3	V	
dv/dt	Peak Diode Recovery ❸				15	V/ns	
$t_{rr}$	Reverse Recovery Time	$I_S = -37\text{A}$ $V_R = 250\text{V}$ $di/dt = 100\text{A}/\mu\text{s}$	$T_j = 25^\circ\text{C}$			280	ns
			$T_j = 125^\circ\text{C}$			600	
$Q_{rr}$	Reverse Recovery Charge		$T_j = 25^\circ\text{C}$			2.3	$\mu\text{C}$
			$T_j = 125^\circ\text{C}$			6.4	

❶  $E_{on}$  includes diode reverse recovery.

❷ In accordance with JEDEC standard JESD24-1.

❸ dv/dt numbers reflect the limitations of the circuit rather than the device itself.

$$I_S \leq -37\text{A} \quad di/dt \leq 100\text{A}/\mu\text{s} \quad V_R \leq V_{DSS} \quad T_j \leq 150^\circ\text{C}$$

**Thermal and package characteristics**

Symbol	Characteristic	Min	Typ	Max	Unit	
R <sub>thJC</sub>	Junction to Case			0.40	°C/W	
V <sub>ISOL</sub>	RMS Isolation Voltage, any terminal to case t =1 min, I <sub>isol</sub> <1mA, 50/60Hz	2500			V	
T <sub>J</sub>	Operating junction temperature range	-40		150	°C	
T <sub>STG</sub>	Storage Temperature Range	-40		125		
T <sub>C</sub>	Operating Case Temperature	-40		100		
Torque	Mounting torque		To heatsink	M4	4.7	N.m
Wt	Package Weight				110	g

**Temperature sensor NTC**

Symbol	Characteristic	Min	Typ	Max	Unit
R <sub>25</sub>	Resistance @ 25°C		68		kΩ
B <sub>25/85</sub>	T <sub>25</sub> = 298.16 K		4080		K

$$R_T = \frac{R_{25}}{\exp \left[ B_{25/85} \left( \frac{1}{T_{25}} - \frac{1}{T} \right) \right]}$$

T: Thermistor temperature  
R<sub>T</sub>: Thermistor value at T

**Package outline**

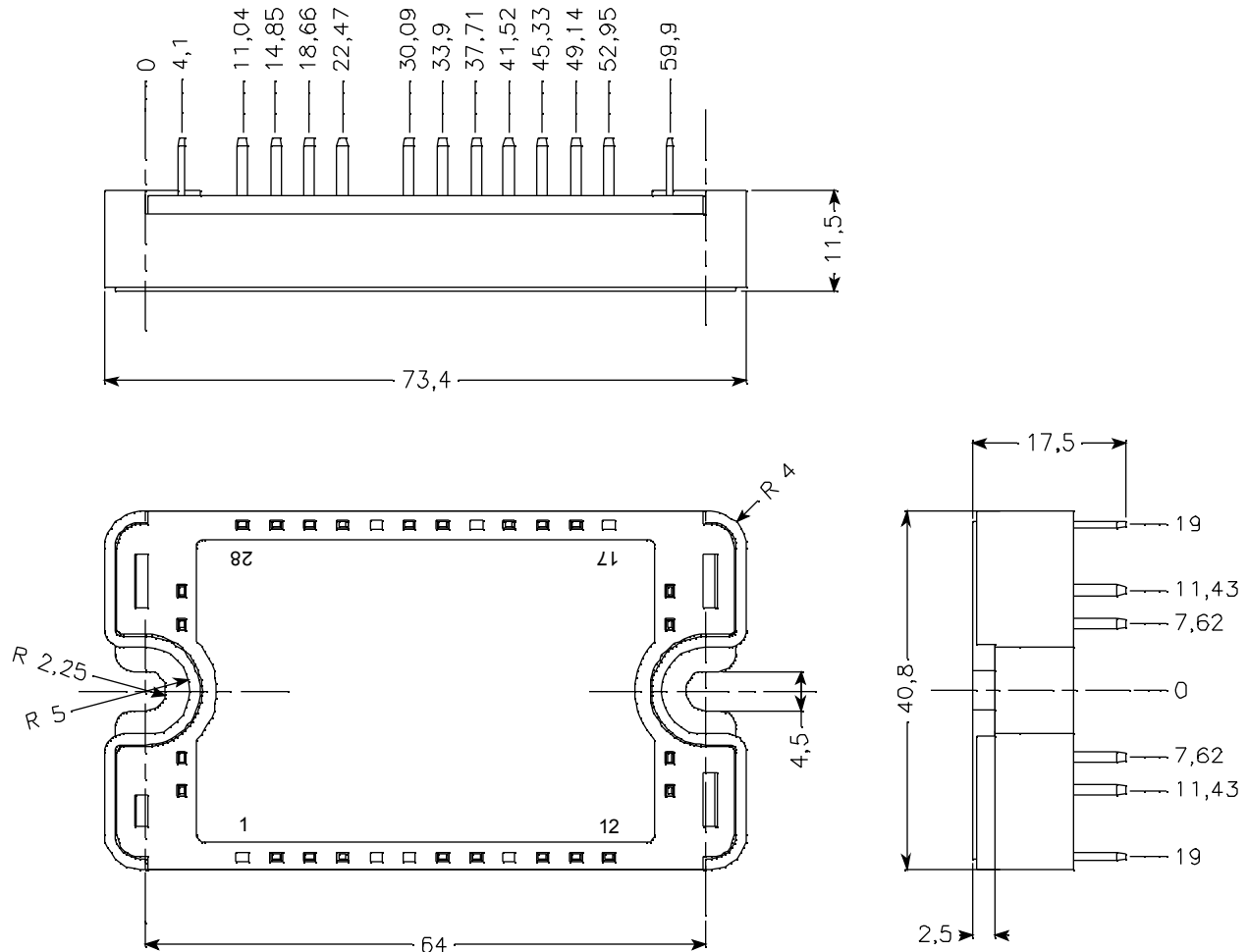

**Typical Performance Curve**

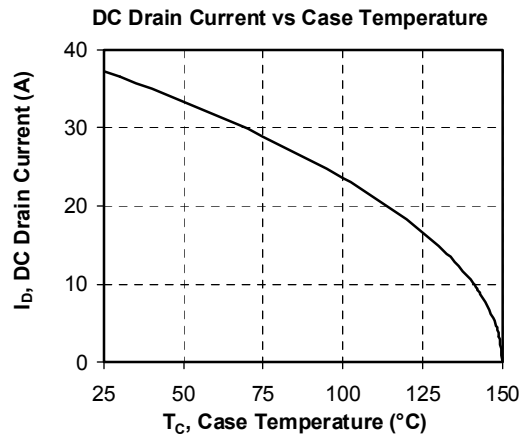
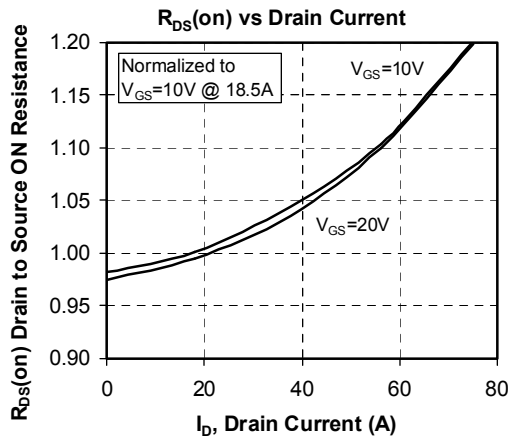
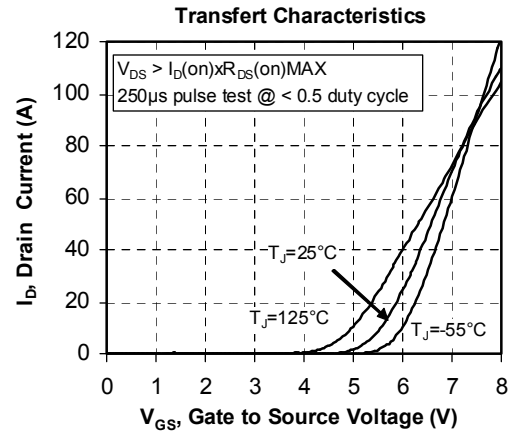
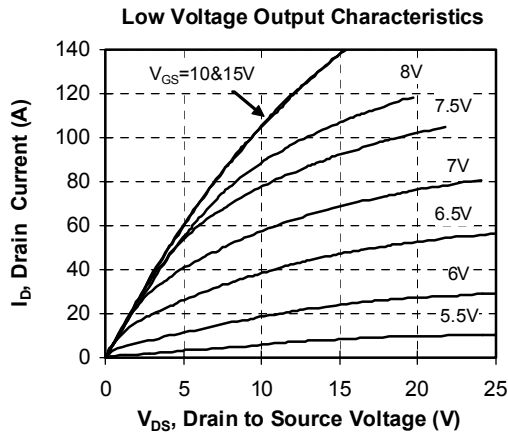
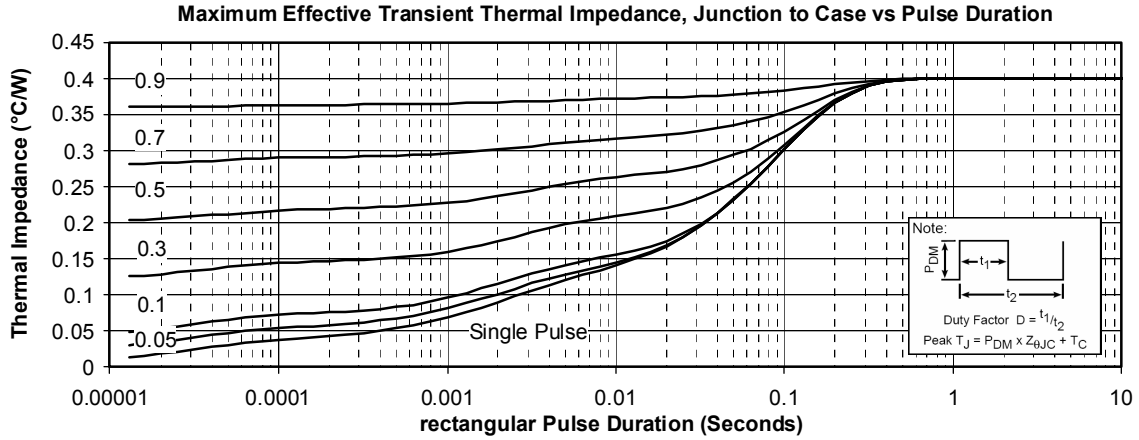

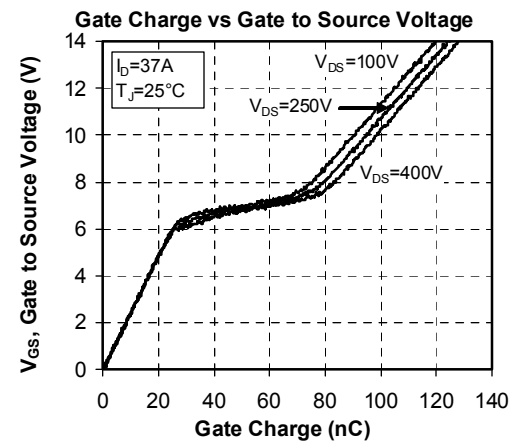
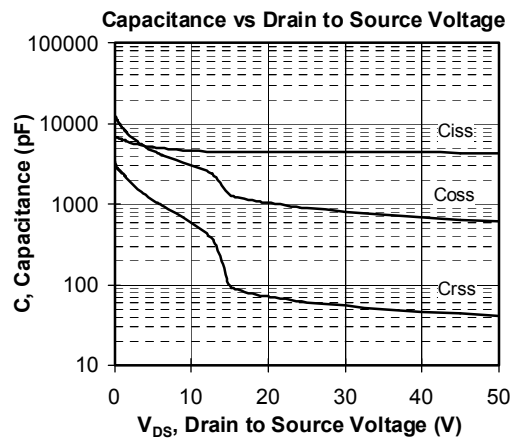
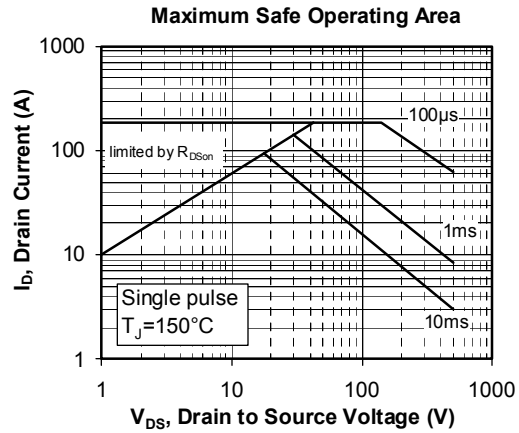
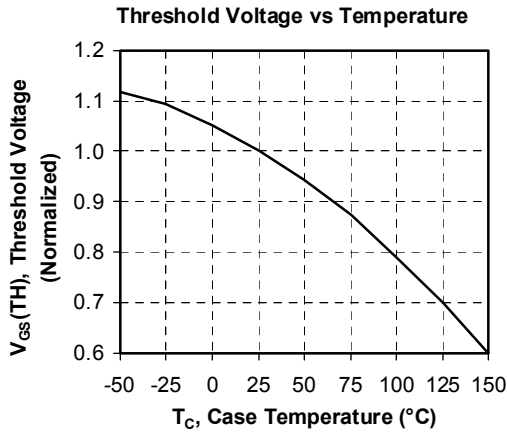
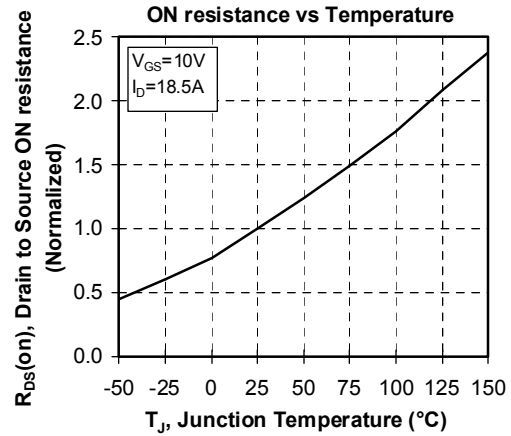
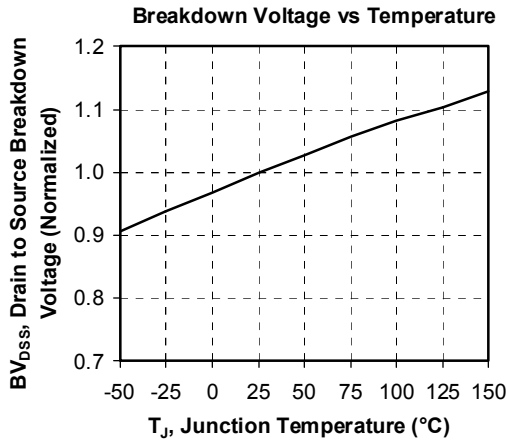

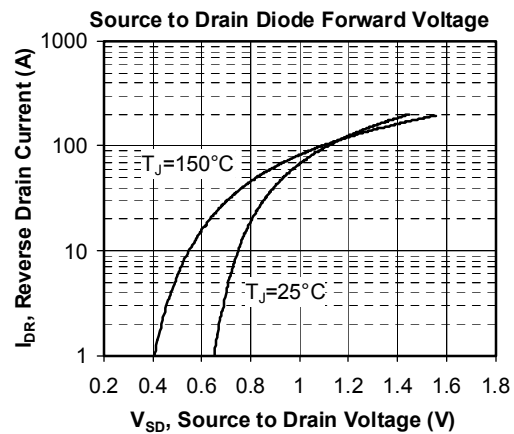
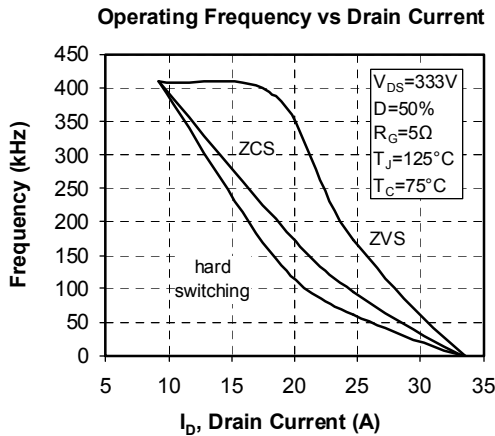
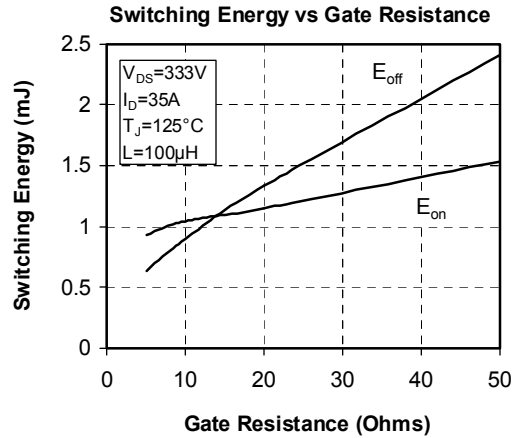
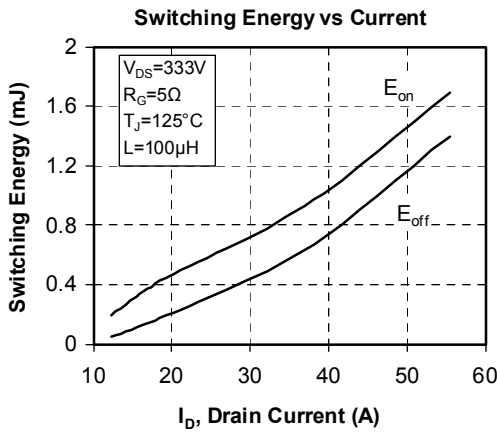
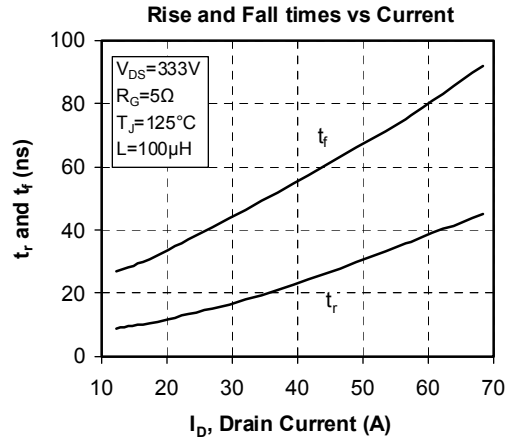
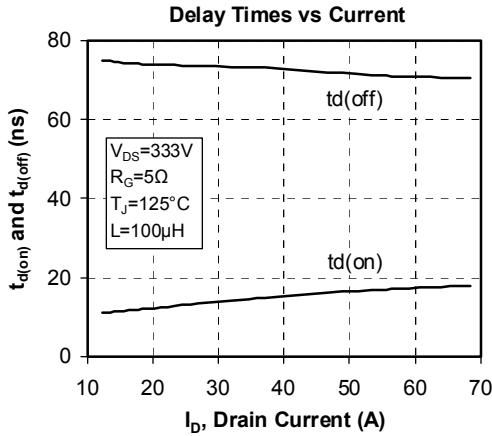

APT reserves the right to change, without notice, the specifications and information contained herein

APT's products are covered by one or more of U.S. patents 4,895,810 5,045,903 5,089,434 5,182,234 5,019,522 5,262,336 6,503,786 5,256,583 4,748,103 5,283,202 5,231,474 5,434,095 5,528,058 and foreign patents. U.S. and Foreign patents pending. All Rights Reserved.