

DATA SHEET

**MCS 0402; MCT 0603;
MCU 0805
Professional flat chip resistors**

Product specification
Supersedes data of 8th June 2001
File under BCcomponents, BC08

2002 Dec 19

Professional flat chip resistors



**MCS 0402; MCT 0603;
MCU 0805**

FEATURES

- Advanced thin film technology
- Advanced dissipation rating: 100 mW for 0603
- Excellent overall stability: Class 0,5
- Green product, supports lead-free soldering.

Case sizes

Imperial:	0402	0603	0805
Metric:	RR 1005M	RR 1608M	RR 2012M

APPLICATIONS

- Telecommunication
- Medical equipment
- Industrial equipment.

DESCRIPTION

MCS 0402, MCT 0603 and MCU 0805 Professional Thin Film Flat Chip Resistors are the perfect choice for most fields of modern professional electronics where reliability and stability is of major concern. Typical applications include telecommunication, medical equipment and high-end computer and audio/video electronics.

Production is strictly controlled and follows an extensive set of instructions established for reproducibility. A homogeneous film of metal alloy is deposited on a super high grade (96% Al₂O₃) ceramic substrate and conditioned to achieve the desired temperature coefficient. Specially designed inner contacts are deposited on both sides. A special laser is used to achieve the target value by smoothly cutting a meander groove in the resistive layer without damaging the ceramics. For the high ohmic range, optimized Cermet products provide comparable properties. The resistor elements are covered by a protective coating designed for electrical, mechanical and climatic protection. The terminations receive a final pure tin on nickel plating.

The result of the determined production is verified by an extensive testing procedure and optical inspection performed on 100% of the individual chip resistors. Only accepted products are laid directly into the paper tape in accordance with **EN 60286-3**.

The resistors are suitable for processing on automatic SMD assembly systems. They are suitable for automatic soldering using wave, reflow or vapour phase. The encapsulation is resistant to all cleaning solvents commonly used in the electronics industry, including alcohols, esters and aqueous solutions.

The resistors are lead-free, the pure tin plating provides compatibility with lead-free soldering processes. The immunity of the plating against tin whisker growth has been proven under extensive testing. All products comply with the CEFIC-EECA-EICTA list of legal restrictions on hazardous substances. Solderability is specified for 2 years after production or re-qualification. The permitted storage time is 20 years.

The resistors are tested in accordance with EN 140401-801 (superseding CECC 40401-801) which refers to **EN 60115-1** and **EN140400**. Approval of conformity is indicated by the CECC logo on the package label.

BCcomponents BEYSCHLAG has achieved "**Approval of Manufacturer**" in accordance with **EN 100114-1**. The release certificate for "**Technology Approval Schedule**" in accordance with **CECC 240 001** based on **EN 100114-6** is granted for the BCcomponents BEYSCHLAG manufacturing process.

This product family of thin film flat chip resistors is completed by **Zero Ohm Jumpers**.

On request, resistors are available with established reliability in accordance with **CECC 40 401-801 Version E**. Please refer to the special data sheet for information on failure rate level, available resistance ranges and order codes.

Professional flat chip resistors**MCS 0402; MCT 0603;
MCU 0805****QUICK REFERENCE DATA**

DESCRIPTION	MCS 0402		MCT 0603		MCU 0805	
Metric size	RR 1005M		RR 1608M		RR 2012M	
Resistance range	10 Ω to 4,99 M Ω		1 Ω to 10 M Ω		10 Ω to 332 k Ω	
Resistance tolerance	$\pm 1\%$; $\pm 0,5\%$				$\pm 0,5\%$	
Temperature coefficient	± 50 ppm/K; ± 25 ppm/K				± 25 ppm/K	
Operation mode	standard	power	standard	power	standard	power
Climatic category (LCT/UCT/days)	55/125/56	55/155/56	55/125/56	55/155/56	55/125/56	55/155/56
Rated dissipation, P_{70}	0,063 W	0,1 W	0,1 W	0,125 W	0,125 W	0,2 W
Operating voltage, U_{\max} AC/DC	50 V		75 V		150 V	
Film temperature	125 $^{\circ}$ C	155 $^{\circ}$ C	125 $^{\circ}$ C	155 $^{\circ}$ C	125 $^{\circ}$ C	155 $^{\circ}$ C
Max. resistance change at P_{70} for resistance range, $\Delta R/R$ max., after:	10 Ω to 4,99 M Ω		1 Ω to 10 M Ω		10 Ω to 332 k Ω	
1 000 h	$\leq 0,25\%$	$\leq 0,5\%$	$\leq 0,25\%$	$\leq 0,5\%$	$\leq 0,25\%$	$\leq 0,5\%$
8 000 h	$\leq 0,5\%$	$\leq 1,0\%$	$\leq 0,5\%$	$\leq 1,0\%$	$\leq 0,5\%$	$\leq 1,0\%$
225 000 h	$\leq 1,5\%$		$\leq 1,5\%$		$\leq 1,5\%$	
Specified lifetime	225 000 h	8 000 h	225 000 h	8 000 h	225 000 h	8 000 h
Insulation voltage:						
1 minute; U_{ins}	75 V		100 V		200 V	
continuous	75 V		75 V		75 V	
Failure rate	$\leq 2 \times 10^{-9}/\text{h}$		$\leq 2 \times 10^{-9}/\text{h}$		$\leq 2 \times 10^{-9}/\text{h}$	

Professional flat chip resistors**MCS 0402; MCT 0603;
MCU 0805****Table 1** Temperature coefficient and resistance range

DESCRIPTION		RESISTANCE VALUE ⁽¹⁾		
T.C.	TOLERANCE	MCS 0402	MCT 0603	MCU 0805
±50 ppm/K	±1%	10 Ω to 4,99 MΩ	1 Ω to 10 MΩ	–
	±0,5%	100 Ω to 100 kΩ	47 Ω to 221 kΩ	–
±25 ppm/K	±0,5%	100 Ω to 100 kΩ	47 Ω to 221 kΩ	10 Ω to 332 kΩ
Jumper		≤ 20 mΩ; $I_{max} = 0,63$ A	≤ 20 mΩ; $I_{max} = 1$ A	≤ 20 mΩ; $I_{max} = 1,5$ A

Note

1. Resistance values to be selected for ±1% tolerance from E24 and E96; for ±0,5% tolerance from E24 and E192.

Resistance ranges printed in bold are preferred T.C. / tolerance combinations with optimized availability.

Professional flat chip resistors

**MCS 0402; MCT 0603;
MCU 0805**

ORDERING INFORMATION

Components may be ordered by using either a simple clear text code; see "Type description and ordering code" or BCcomponents' unique 12NC.

Numeric ordering code (12NC)

- The resistors have a 12-digit ordering code starting with 2312.
- The subsequent 4 digits indicate the resistor type specification and packaging; see Table 2.
- The remaining 4 digits indicate the resistance value:
 - The first 3 digits indicate the resistance value.
 - The last digit indicates the resistance decade in accordance with Table 3.

Table 2 12NC ordering code indicating resistor type and packaging

DESCRIPTION			ORDERING CODE 2312		
			CARDBOARD TAPE ON REEL		
TYPE	T.C.	TOL.	P5 5 000 units	E0 10000 units	PW 20000 units
MCS 0402	±50 ppm/K	±1%	–	275 1....	–
		±0,5%	–	275 5....	–
	±25 ppm/K	±0,5%	–	276 5....	–
	jumper	–	–	275 90001	–
MCT 0603	±50 ppm/K	±1%	215 1....	–	205 1....
		±0,5%	215 5....	–	205 5....
	±25 ppm/K	±0,5%	216 5....	–	206 5....
	jumper	–	215 90001	–	205 90001
MCU 0805	±25 ppm/K	±0,5%	256 5....	–	246 5....
	jumper	–	255 90001	–	245 90001

Resistance ranges printed in bold are preferred T.C. / tolerance combinations with optimized availability.

Table 3 Last digit of 12NC indicating resistance decade

RESISTANCE DECADE	LAST DIGIT
1 to 9,99 Ω	8
10 to 99,9 Ω	9
100 to 999 Ω	1
1 to 9,99 kΩ	2
10 to 99,9 kΩ	3
100 to 999 kΩ	4
1 to 9,99 MΩ	5

ORDERING EXAMPLE

The ordering code of a MCT 0603 resistor, value 47 kΩ and TC 50 with ±1% tolerance, supplied in cardboard tape of 5 000 units per reel is: 2312 215 14703.

Professional flat chip resistors

**MCS 0402; MCT 0603;
MCU 0805**

Type description and ordering code

- We recommend to use a clear text ordering code to minimize the risk of errors in order handling.

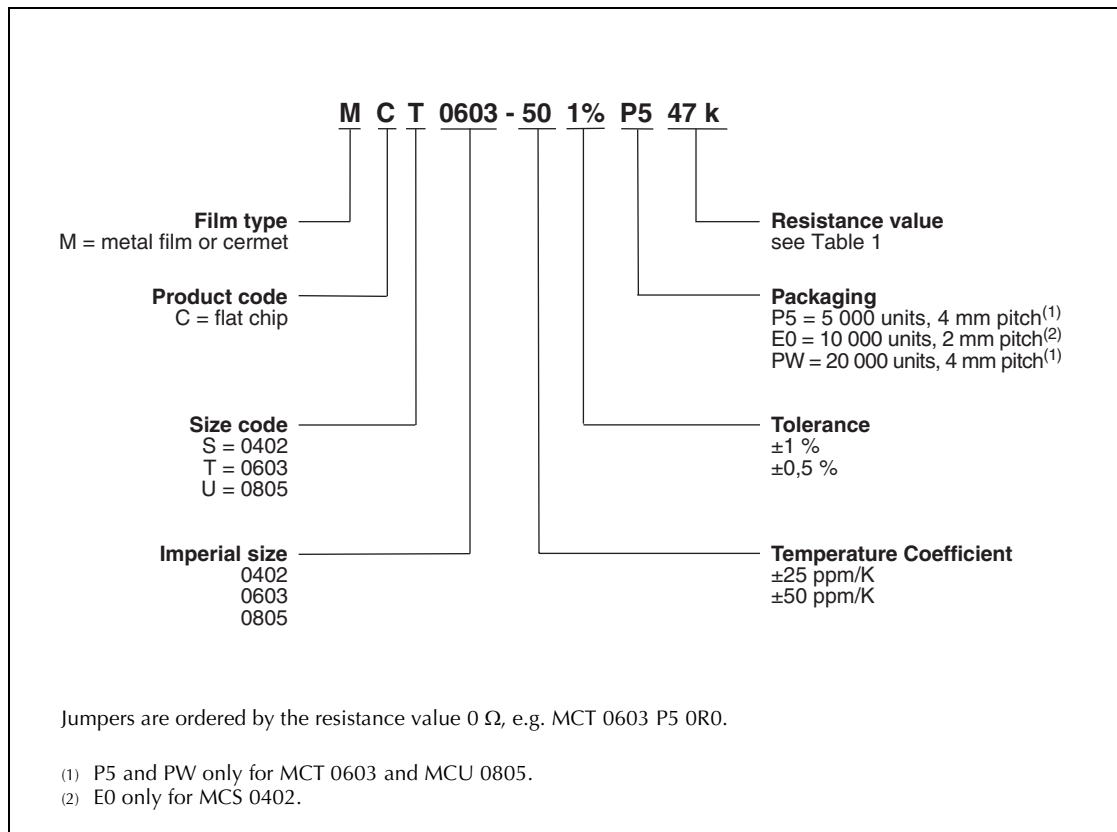

Professional flat chip resistors

**MCS 0402; MCT 0603;
MCU 0805**

FUNCTIONAL DESCRIPTION

Derating

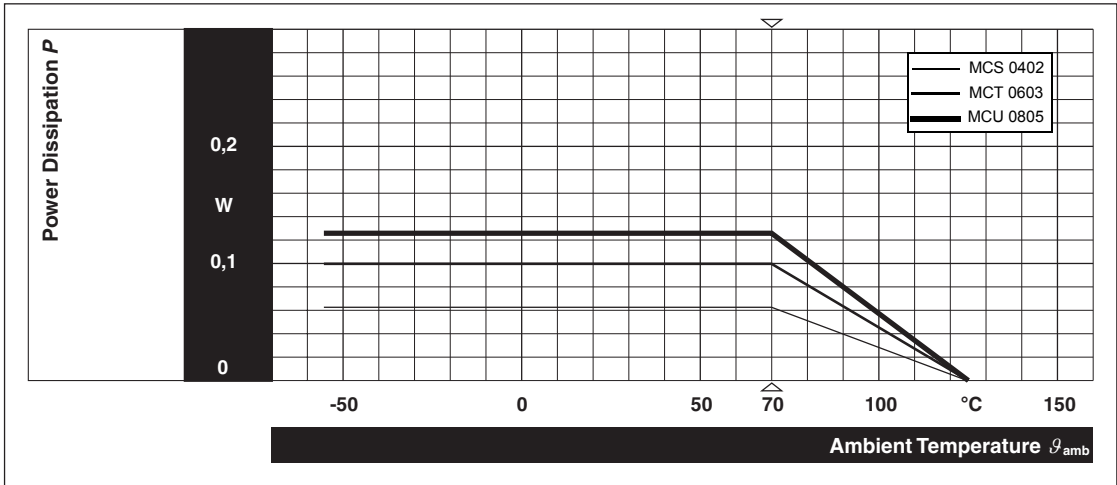

Fig.1 Derating, standard operation.

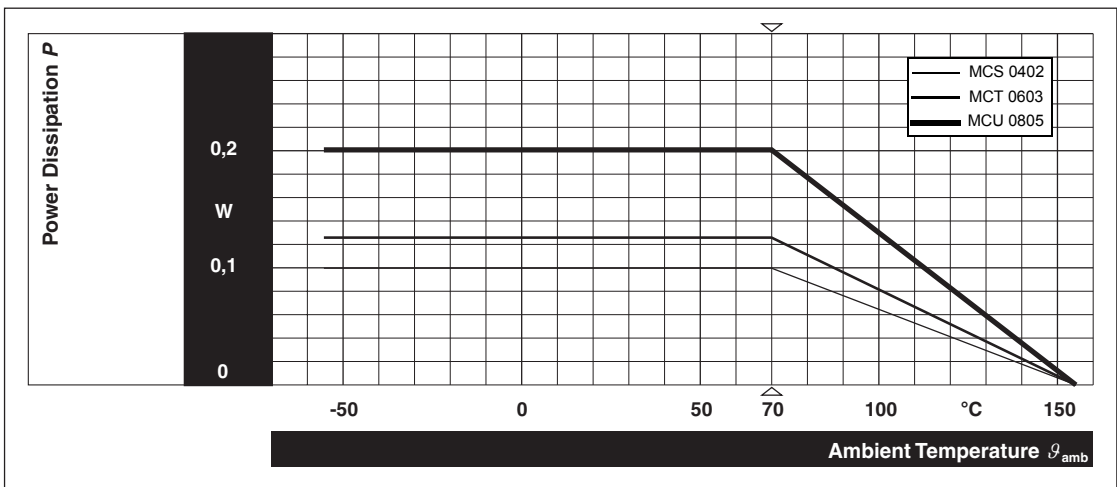

Fig.2 Derating, power operation.

Professional flat chip resistors

**MCS 0402; MCT 0603;
MCU 0805**

Single pulse

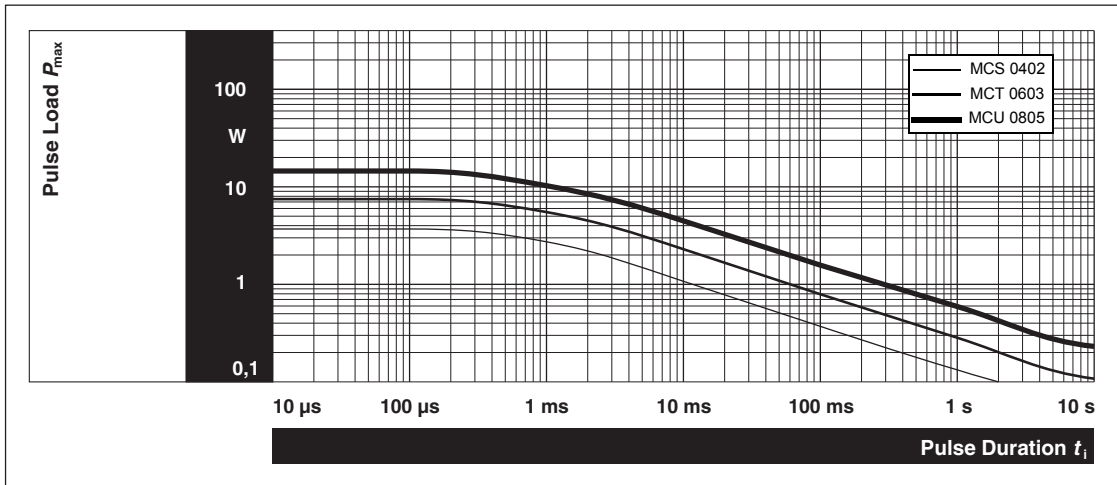

Fig.3 Maximum pulse load, single pulse; for permissible resistance change equivalent to 8000 h operation.

Continuous pulse

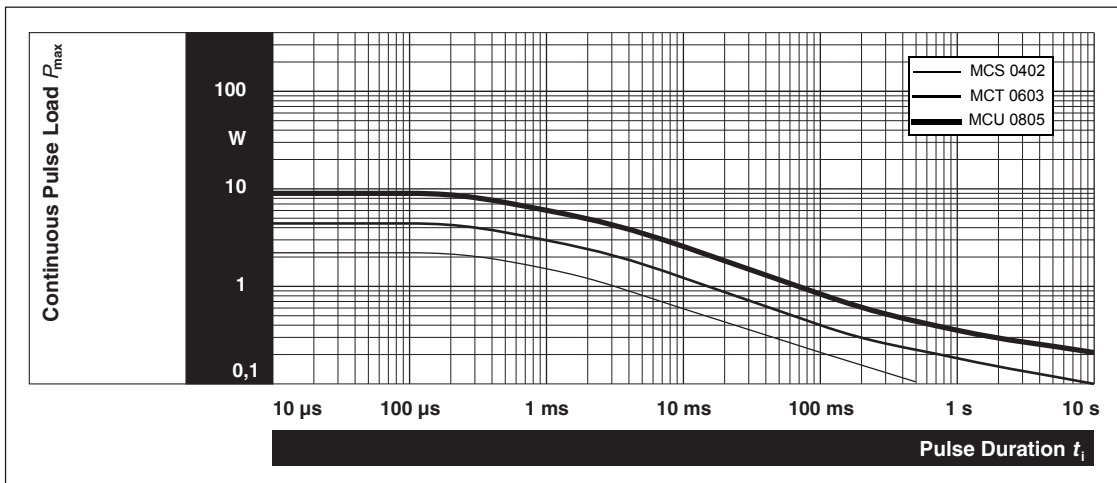

Fig.4 Maximum pulse load, continuous pulses; for permissible resistance change equivalent to 8000 h operation.

Professional flat chip resistors**MCS 0402; MCT 0603;
MCU 0805****Pulse voltage**

Fig.5 Maximum pulse voltage, single and continuous pulses; for permissible resistance change equivalent to 8000 h operation.

Professional flat chip resistors

MCS 0402; MCT 0603;
MCU 0805

1,2/50 pulse

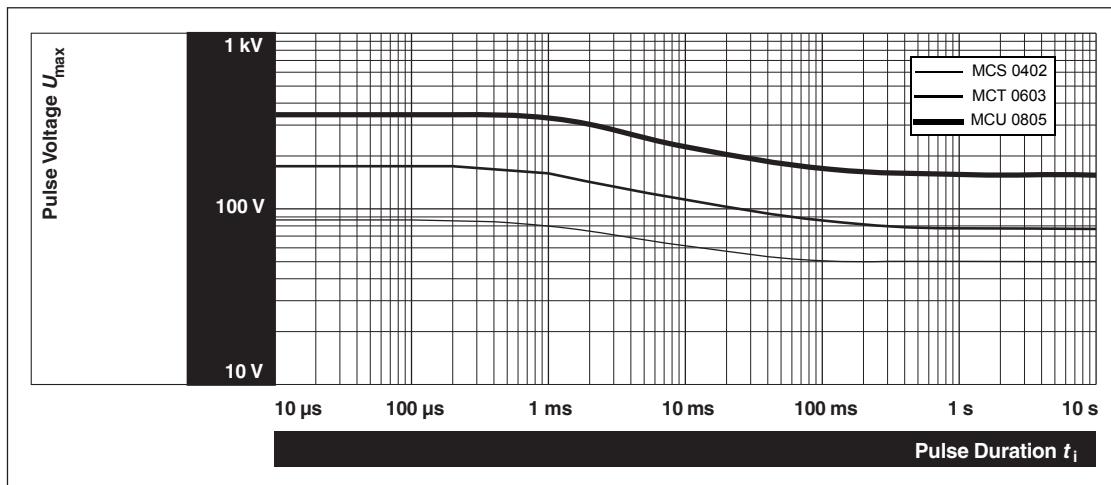
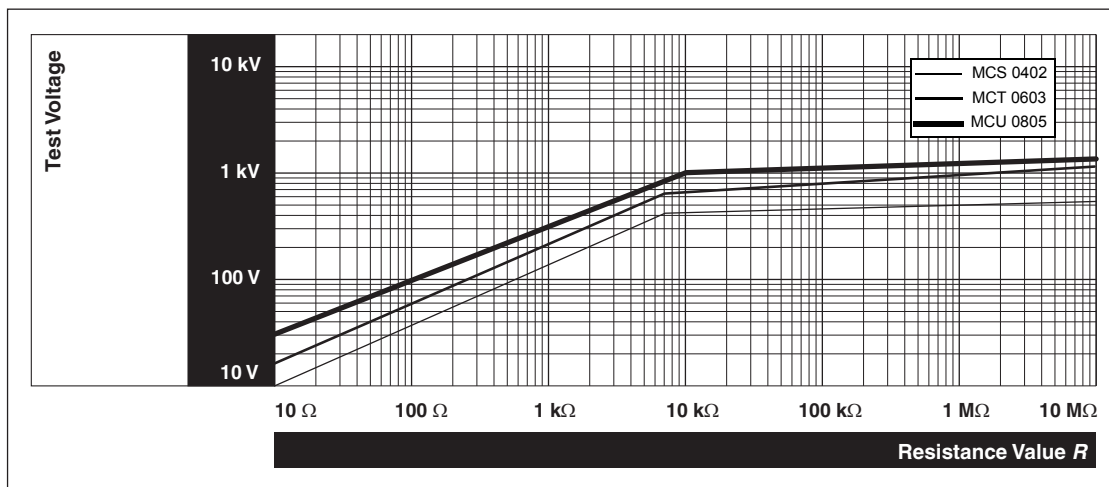

Fig.6 Pulse load rating in accordance with IEC 60115-1 clause 4.27; 1,2 μs / 50 μs; 5 pulses at 12 s interval; for permissible resistance change 0,5%.

10/700 pulse

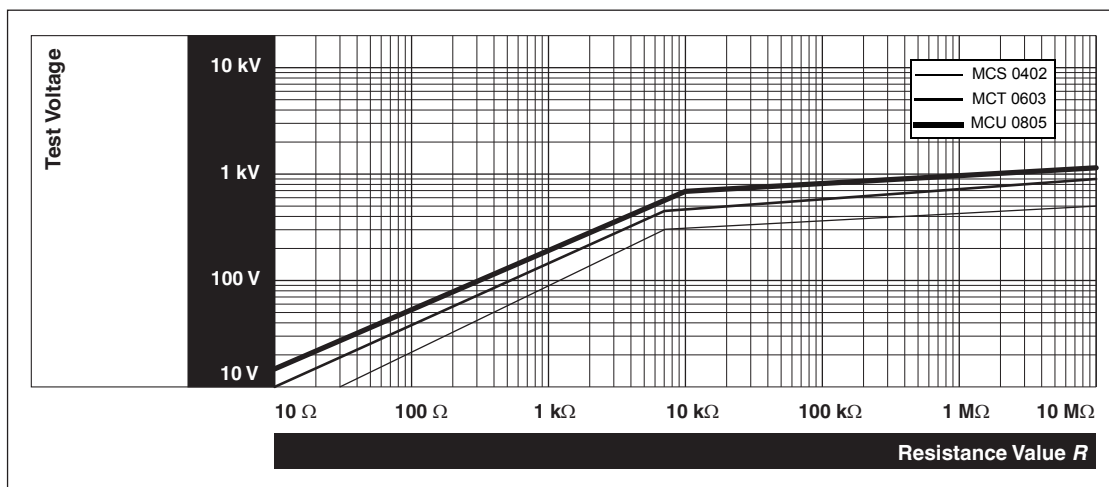

Fig.7 Pulse load rating in accordance with IEC 60115-1 clause 4.27; 10 μs / 700 μs; 10 pulses at 1 minute intervals; for permissible resistance change 0,5%.

Professional flat chip resistors

MCS 0402; MCT 0603;
MCU 0805

Current noise

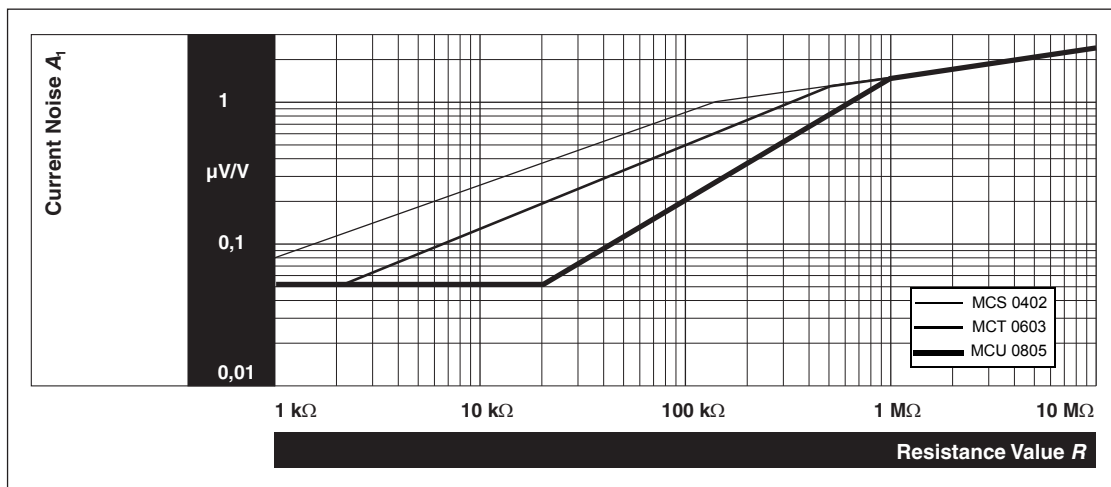

Fig.8 Current noise A_1 in accordance with IEC 60195.

RF-behaviour

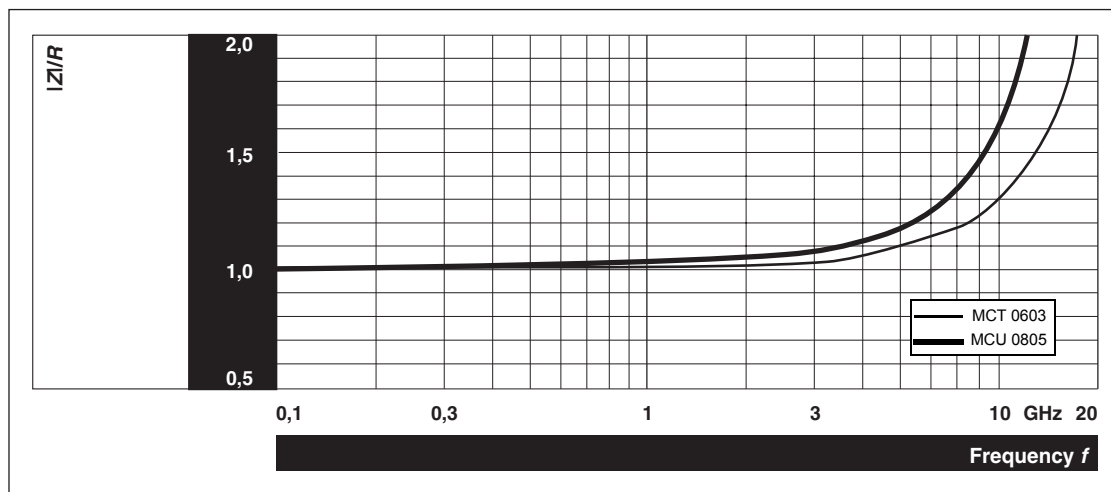

Fig.9 $|Z|/R$ for 49,9 Ω chip resistor.

Professional flat chip resistors

MCS 0402; MCT 0603;
MCU 0805

MECHANICAL DATA

Outlines

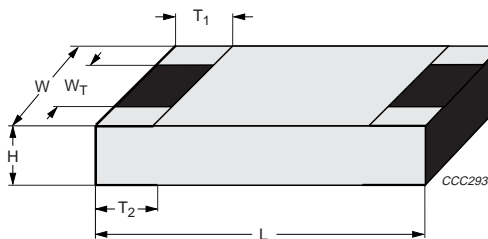

For dimensions see Table 4.

Fig.10 Outlines.

Table 4 Chip resistor types, mass and relevant physical dimensions; see Fig.10

TYPE	H (mm)	L (mm)	W (mm)	W _T (mm)	T ₁ (mm)	T ₂ (mm)	MASS (mg)
MCS 0402	0,32 ± 0,05	1,0 ± 0,05	0,5 ± 0,05	> 75% of W	0,2 +0,1/-0,15	0,2 ± 0,1	0,6
MCT 0603	0,45 +0,1/-0,05	1,55 ± 0,05	0,85 ± 0,1	> 75% of W	0,3 +0,15/-0,2	0,3 +0,15/-0,2	1,9
MCU 0805	0,45 +0,1/-0,05	2,0 ± 0,1	1,25 ± 0,15	> 75% of W	0,4 +0,1/-0,2	0,4 +0,1/-0,2	4,6

Professional flat chip resistors

**MCS 0402; MCT 0603;
MCU 0805**

TESTS AND REQUIREMENTS

All tests are carried out in accordance with the following specifications:

- EN 60115-1, Generic specification (includes tests)
- EN 140 400, Sectional specification (includes schedule for qualification approval)
- EN 140 401-801, Detail specification (includes schedule for conformance inspection)

The components are approved in accordance with the European CECC-system, where applicable. Table 5 contains only the most important tests. For the full test schedule refer to the documents listed above. The testing also covers most of the requirements specified by EIA/IS-703 and JIS-C-5202.

The tests are carried out in accordance with IEC 60068 and under standard atmospheric conditions in accordance with IEC 60068-1, 5.3. Climatic category LCT/UCT/56 (rated temperature range: Lower Category Temperature, Upper

Category Temperature; damp heat, long term, 56 days) is valid.

Unless otherwise specified the following values apply:

- Temperature: 15 °C to 35 °C
- Relative humidity: 45% to 75%
- Air pressure: 86 kPa to 106 kPa (860 mbar to 1 060 mbar).

The components are mounted for testing on boards in accordance with EN 60115-1, 4.31 unless otherwise specified.

The requirements stated in Table 5 are based on the required tests and permitted limits of EN 140 401-801. However, some additional tests and a number of improvements against those minimum requirements have been included.

Table 5 Test procedures and requirements

EN 60115-1 CLAUSE	IEC 60068-2 TEST METHOD	TEST	PROCEDURE	REQUIREMENTS PERMISSIBLE CHANGE ($\Delta R/R$)	
				STABILITY CLASS 0,5	STABILITY CLASS 1
			stability for product types:		
			MCS 0402	10 Ω to 33,2 k Ω	33,2 k Ω to 4,99 M Ω
			MCT 0603	10 Ω to 100 k Ω	1 Ω to <10 Ω ; 100 k Ω to 10 M Ω
			MCU 0805	10 Ω to 221 k Ω	221 k Ω to 332 k Ω
4.5	–	resistance		$\pm 1\%$; $\pm 0,5\%$	
4.8.4.2	–	temperature coefficient	at 20 / –55 / 20 °C and 20 / 125 / 20 °C	± 50 ppm/K; ± 25 ppm/K	
4.25.1	–	endurance at 70 °C: standard operation mode	$U = \sqrt{P_{70}} \times R$ or $U = U_{max}$; whichever is the less severe; 1,5 h on; 0,5 h off 70 °C; 1000 h 70 °C; 8000 h	$\pm(0,25\%R + 0,05 \Omega)$ $\pm(0,5\%R + 0,05 \Omega)$	
	–	endurance at 70 °C: power operation mode	$U = \sqrt{P_{70}} \times R$ or $U = U_{max}$; whichever is the less severe; 1,5 h on; 0,5 h off 70 °C; 1000 h 70 °C; 8000 h	$\pm(0,5\%R + 0,05 \Omega)$ $\pm(1\%R + 0,05 \Omega)$	

Professional flat chip resistors

MCS 0402; MCT 0603;
MCU 0805

EN 60115-1 CLAUSE	IEC 60068-2 TEST METHOD	TEST	PROCEDURE	REQUIREMENTS PERMISSIBLE CHANGE ($\Delta R/R$)	
				STABILITY CLASS 0,5	STABILITY CLASS 1
			stability for product types:		
			MCS 0402	10 Ω to 33,2 k Ω	33,2 k Ω to 4,99 M Ω
			MCT 0603	10 Ω to 100 k Ω	1 Ω to <10 Ω ; 100 k Ω to 10 M Ω
			MCU 0805	10 Ω to 221 k Ω	221 k Ω to 332 k Ω
4.25.3	–	endurance at upper category temperature	125 °C; 1000 h 155 °C; 1000 h	$\pm(0,25\%R + 0,05 \Omega)$ $\pm(0,5\%R + 0,05 \Omega)$	$\pm(0,5\%R + 0,05 \Omega)$ $\pm(1\%R + 0,05 \Omega)$
4.24	3 (Ca)	damp heat, steady state	40 \pm 2 °C; 56 days; 93 +2/-3% RH	$\pm(0,5\%R + 0,05 \Omega)$	$\pm(1\%R + 0,05 \Omega)$
4.23		climatic sequence:			
4.23.2	2 (Ba)	dry heat	UCT; 16 h		
4.23.3	30 (Db)	damp heat, cyclic	55 °C; 24 h; >90% RH; 1 cycle		
4.23.4	1 (Aa)	cold	LCT; 2 h		
4.23.5	13 (M)	low air pressure	8,5 kPa; 2 h; 25 \pm 10 °C		
4.23.6	30 (Db)	damp heat, cyclic	55 °C; 5 days; >90% RH; 5 cycles LCT = -55 °C; UCT = 125 °C	$\pm(0,5\%R + 0,05 \Omega)$	$\pm(1\%R + 0,05 \Omega)$
–	1 (Aa)	cold	-55 °C; 2 h	$\pm(0,1\%R + 0,01 \Omega)$	$\pm(0,25\%R + 0,05 \Omega)$
4.19	14 (Na)	rapid change of temperature	30 minutes at LCT and 30 minutes at UCT; LCT = -55 °C; UCT = 125 °C; 5 cycles	$\pm(0,1\%R + 0,01 \Omega)$ no visible damage	
			LCT = -55 °C; UCT = 125 °C; 1000 cycles	$\pm(0,25\%R + 0,05 \Omega)$ no visible damage	

Professional flat chip resistors

MCS 0402; MCT 0603;
MCU 0805

EN 60115-1 CLAUSE	IEC 60068-2 TEST METHOD	TEST	PROCEDURE	REQUIREMENTS PERMISSIBLE CHANGE ($\Delta R/R$)	
				STABILITY CLASS 0,5	STABILITY CLASS 1
			stability for product types:		
			MCS 0402	10 Ω to 33,2 k Ω	33,2 k Ω to 4,99 M Ω
			MCT 0603	10 Ω to 100 k Ω	1 Ω to <10 Ω ; 100 k Ω to 10 M Ω
			MCU 0805	10 Ω to 221 k Ω	221 k Ω to 332 k Ω
4.13	-	short time overload; standard operation mode	$U = 2,5 \times \sqrt{P_{70} \times R}$ or $U = 2 \times U_{max}$; whichever is the less severe; 5 s	$\pm(0,1\%R + 0,01 \Omega)$	$\pm(0,25\%R + 0,05 \Omega)$
		short time overload; power operation mode		$\pm(0,25\%R + 0,05 \Omega)$	$\pm(0,5\%R + 0,05 \Omega)$
4.27	-	single pulse high voltage overload; standard operation mode	severity no. 4: $U = 10 \times \sqrt{P_{70} \times R}$ or $U = 2 \times U_{max}$; whichever is the less severe; 10 pulses 10 μ s/700 μ s	$\pm(0,5\%R + 0,05 \Omega)$ no visible damage	
4.37	-	periodic electric overload; standard operation mode	$U = \sqrt{15 \times P_{70} \times R}$ or $U = 2 \times U_{max}$; whichever is the less severe; 0,1 s on; 2,5 s off; 1000 cycles	$\pm(0,5\%R + 0,05 \Omega)$ no visible damage	
		periodic electric overload; power operation mode		$\pm(1\%R + 0,05 \Omega)$ no visible damage	
4.22	6 (Fc)	vibration	endurance by sweeping; 10 to 2000 Hz; no resonance; amplitude $\leq 1,5$ mm or ≤ 200 m/s ² ; 6 h	$\pm(0,1\%R + 0,01 \Omega)$ no visible damage	

Professional flat chip resistors

MCS 0402; MCT 0603;
MCU 0805

EN 60115-1 CLAUSE	IEC 60068-2 TEST METHOD	TEST	PROCEDURE	REQUIREMENTS PERMISSIBLE CHANGE ($\Delta R/R$)	
				STABILITY CLASS 0,5	STABILITY CLASS 1
			stability for product types:		
			MCS 0402	10 Ω to 33,2 k Ω	33,2 k Ω to 4,99 M Ω
			MCT 0603	10 Ω to 100 k Ω	1 Ω to <10 Ω ; 100 k Ω to 10 M Ω
			MCU 0805	10 Ω to 221 k Ω	221 k Ω to 332 k Ω
4.17.2	58 (Td)	solderability	solder bath method; SnPb40; non-activated flux 215 \pm 3 $^{\circ}$ C; 3 \pm 0,3 s	good tinning (\geq 95% covered); no visible damage	
			solder bath method; SnAg3Cu0,5 or SnAg3,5; non-activated flux 235 \pm 3 $^{\circ}$ C; 2 \pm 0,2 s	good tinning (\geq 95% covered); no visible damage	
4.18.2	58 (Td)	resistance to soldering heat	solder bath method; 260 \pm 5 $^{\circ}$ C; 10 \pm 1 s	\pm (0,1%R + 0,01 Ω) no visible damage	\pm (0,25%R + 0,05 Ω) no visible damage
4.29	45 (XA)	component solvent resistance	isopropyl alcohol +50 $^{\circ}$ C; method 2	no visible damage	
4.32	21 (Ue ₃)	shear (adhesion)	RR 1005M and RR 1608 M; 9 N	no visible damage	
			RR 2012M; 45 N		
4.33	21 (Ue ₁)	substrate bending	depth 2 mm, 3 times	\pm (0,1%R + 0,01 Ω) no visible damage; no open circuit in bent position	
4.7	–	voltage proof	$U_{rms} = U_{ins}$; 60 \pm 5 s	no flashover or breakdown	
4.35	–	flammability	IEC 60695-2-2, needle flame test; 10 s	no burning after 30 s	