

Patent No. 4912620

[2 YEAR WARRANTY]

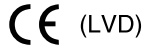

NFS200 SERIES

Triple and quad output

- 5.0 x 9.0 x 2.5 inch package
- Overvoltage and short circuit protection
- 200W with 30CFM
- Adjustable outputs
- Isolated outputs
- Power fail detect signals
- EN55022, EN55011 conducted emissions level A
- UL, VDE, CSA and BABT safety approvals

The NFS200 series is a 200W universal input AC/DC power supply in a 5 x 9 x 2.5 inch package. The NFS200 series has four multiple output models and has proven itself to be highly reliable and versatile product for a wide range of communication and industrial applications, with a very high peak capability on the auxiliary outputs for drive and motor applications. The NFS200 provides 200W of output power with 30CFM of air. Standard features include overvoltage and short circuit protection, adjustable outputs, isolated outputs and power fail detect. The series, with full international safety approval and the CE mark, meets conducted emissions EN55022 level A. The NFS200 series is designed for use in medium power data networking, computer, telecom and industrial applications such as servers, PABX's, printers and process automation.

SPECIFICATION All specifications are typical at nominal input, full load at 25°C unless otherwise stated

OUTPUT SPECIFICATIONS		
Voltage adjustability	+5V output	±5.0%
Line regulation	LL to HL, FL Main output	±0.1% max.
Load regulation	Main output Auxiliary outputs	±2.0% max. ±2.5% max.
Overshoot/undershoot	At turn-on	0%
Transient response	+5V (20A to 30A step)	±200mV max. dev. 500µs recovery to 1.0%
Temperature coefficient	All outputs	±0.02%/°C
Overvoltage protection	+5V output	6.25V±0.5V
Short circuit protection	Yes, with auto-recovery	
Fan output current (See Note 8)	J1: pins 3 and 4	12.1V @ 0.75A max.
INPUT SPECIFICATIONS		
Input voltage range	Universal input	90VAC to 264VAC 130VDC to 370VDC
Input frequency range	47Hz to 63Hz	
Input surge current	110VAC, 60Hz 230VAC, 50Hz	40A max. 80A max.
Safety ground leakage current	110VAC, 60Hz 230VAC, 50Hz	0.9mA max. 1.6mA max.

EMC CHARACTERISTICS		
Conducted emissions	EN55022, FCC part 15	Level A
Radiated emissions	EN55022, FCC part 15	Level A
ESD air	EN61000-4-2, level 3	Perf. criteria 1
ESD contact	EN61000-4-2, level 4	Perf. criteria 1
Surge	EN61000-4-5, level 3	Perf. criteria 1
Fast transients	EN61000-4-4, level 3	Perf. criteria 1
Radiated immunity	EN61000-4-3, level 3	Perf. criteria 1
Conducted immunity	EN61000-4-6, level 3	Perf. criteria 1
GENERAL SPECIFICATIONS		
Hold-up time	110VAC After PFD flag @ 200W	15ms 5ms
Efficiency	110/230VAC @ 200W	70% typ.
Isolation voltage	Input/output Input/chassis	3000VAC 1500VAC
Switching frequency	Variable	80 to 100kHz
Standards and approvals (See Note 9)	VDE0805, EN60950, IEC950 IEC1010, UL1950, BABT CSA C22.2 No. 950	
Weight	1.34kg (47.30oz)	
MTBF (See Note 1)	MIL-HDBK-217E	84,000 hours
ENVIRONMENTAL SPECIFICATIONS		
Thermal performance (See Notes 3, 10)	Operating Non-operating 0°C to 50°C ambient, 30CFM forced air 50°C to 70°C ambient, 30CFM forced air	0°C to +70°C -40°C to +85°C 200W Derate linearly to 100W at 70°C
Relative humidity	Non-condensing	5% to 95% RH
Altitude	Operating Non-operating	10,000 feet max. 40,000 feet max.
Vibration	Three orthogonal axes, random vibration, 10 minute test for each axis	2.4G rms 5 to 500Hz

200 Watt AC/DC universal input switch mode power supplies





OUTPUT VOLTAGE	OUTPUT CURRENTS			RIPPLE (4)	TOTAL REGULATION (5)	MODEL NUMBER (A)	
	MIN (1)	PEAK (2)	MAX (3)			OPEN FRAME	CASED
+5.1V	5.0A	30A	30.0A	50mV	±2%	NFS200-7601 (6)	NFS200-7601CF (6)
+12.1V	0A	12A	8.0A	120mV	±2.5%		
-12.1V	0A	5.0A	4.0A	120mV	±2.5%		
-5.2V (6)	0A	6.0A	6.0A	50mV	±2.5%		
+5.1V	5.0A	30A	30.0A	50mV	±2%	NFS200-7602 (7)	NFS200-7602CF (7)
+12.1V	0A	12A	8.0A	120mV	±2.5%		
-12.1V	0A	5.0A	4.0A	120mV	±2.5%		
24.0V (7)	0A	3.0A	3.0A	240mV	±2.5%		
+5.1V	5.0A	30A	30.0A	50mV	±2%	NFS200-7603 (7)	NFS200-7603CF (7)
+12.1V	0A	12A	8.0A	120mV	±2.5%		
-12.1V	0A	5.0A	4.0A	120mV	±2.5%		
12.0V (7)	0A	4.0A	4.0A	120mV	±2.5%		
+5.1V	5.0A	30A	30A	50mV	±2.5%	NFS200-7608	NFS200-7608CF
+12.1V	0A	12.0A	8.0A	120mV	±2.5%		
-12.1V	0A	5.0A	4.0A	120mV	±2.5%		

PIN CONNECTIONS				
TB1	NFS200-7601	NFS200-7602	NFS200-7603	NFS200-7608
Term 1	AC Line	AC Line	AC Line	AC Line
Term 2	AC Neutral	AC Neutral	AC Neutral	AC Neutral
Term 3	Safety Ground	Safety Ground	Safety Ground	Safety Ground
TB2				
Term 1	+5.1V	+5.1V	+5.1V	+5.1V
Term 2	+5.1V	+5.1V	+5.1V	+5.1V
Term 3	Return	Return	Return	Return
Term 4	Return	Return	Return	Return
Term 5	Return	Return	Return	Return
Term 6	+12.1V	+12.1V	+12.1V	+12.1V
Term 7	-12.1V	-12.1V	-12.1V	-12.1V
Term 8	-5.2V(6)	24V Return(7)	12V Return(7)	
Term 9	-5.2V Return(6)	+24V(7)	+12V(7)	
Term 10				
J1				
Pin 1	PFD	PFD	PFD	PFD
Pin 2	PFD Return	PFD Return	PFD Return	PFD Return
Pin 3	Fan Return	Fan Return	Fan Return	Fan Return
Pin 4(8)	Fan	Fan	Fan	Fan

Notes

- 25W minimum total output load required for reliable operation. Also, ±12V output peak current capability requires a +5.1V @ 5A minimum load.
- Peak output current lasting less than 30 seconds with duty cycle less than 10%. During peak loading, outputs may drift outside total regulation limits.
- Requires forced air, 30CFM minimum, or 350LFM.
- Figure is peak-to-peak. Output noise is measured across a 50MHz bandwidth using a 12 inch twisted pair, terminated with a 47µF capacitor.
- Total regulation is defined as the static output regulation at 25°C, including initial tolerance, line voltage within stated limits, load currents within stated limits, and output voltages adjusted to their factory settings.
- Although the -5.2V return is electrically connected to the 'main' return (terminals 3, 4 and 5, which are all connected together), Artesyn Technologies recommends that system cabling allow -5.2V return current flow to terminal 9.
- The auxiliary output is floating, and can be referenced as either positive or negative. The return is the negative terminal of the pair.
- Any fan current must be subtracted from the total available +12.1V current. Supplied fans draw 0.14A.
- This product is only for installation by professional installers within other equipment and must not be operated as a stand alone product.
- Derating curve is application specific for ambient temperatures >50°C, for optimum reliability no part of the heat sink should exceed 90°C and no semi-conductor temperature should exceed 100°C.

International Safety Standard Approvals

-  VDE0805/EN60950/IEC950/IEC1010
File No. 10401-3336-1058 Licence No. 3613
-  UL1950 File No. E136005
-  CSA C22.2 No. 950 File No. LR41062C
-  Certificate No. PS/603176

200 Watt AC/DC universal input switch mode power supplies

Mechanical notes

A A standard cover and fan assembly can be added during manufacturing. Details are on page 84. To order, add suffix 'CF' to the model number. e.g. NFS200-7601CF.

AC (TB1) connector

Kulka P/N 4597A-6/32-03 or equivalent

DC (TB2) connector

Kulka P/N 4597A-6/32-09 or equivalent

J1 mating connector

Molex 22-01-1043 or equivalent with 4809 series or equivalent crimp terminal

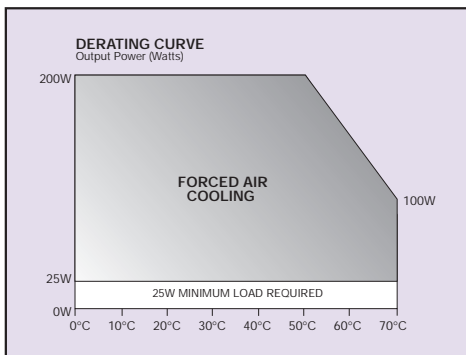
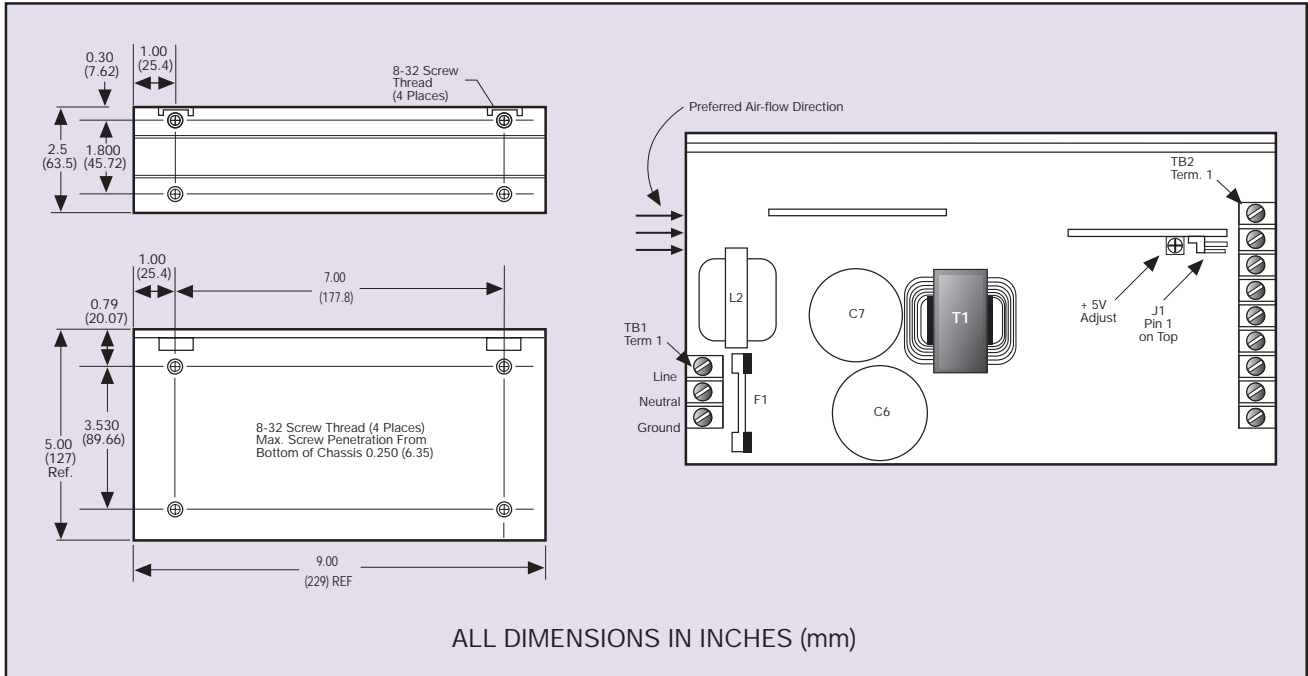

POWER FAIL DETECT SIGNAL

50ms ≤ T1 ≤ 200ms
T2 will vary with line and load
T3 ≥ 5ms
Pout: 200W
PFD output is an open collector which will sink ≤40mA in the low state

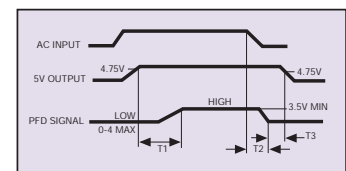

Data Sheet © Artesyn Technologies, "REG. U.S. Pat. & Tm. Off", 2000

The information and specifications contained in this data sheet are believed to be correct at time of publication. However, Artesyn Technologies accepts no responsibility for consequences arising from printing errors or inaccuracies. Specifications are subject to change without notice. No rights under any patent accompany the sale of any such product(s) or information contained herein.



<http://www.artesyn.com>