



64K x 4 Static RAM

Features

- High speed
— 12 ns
- Output enable (\overline{OE}) feature (7C195 and 7C196)
- CMOS for optimum speed/power
- Low active power
— 880 mW
- Low standby power
— 220 mW
- TTL-compatible inputs and outputs
- Automatic power-down when deselected

Functional Description

The CY7C194, CY7C195, and CY7C196 are high-performance CMOS static RAMs organized as 65,536 by 4 bits. Easy memory expansion is provided by active LOW Chip En-

able(s) (\overline{CE} on the CY7C194 and CY7C195, \overline{CE}_1 , \overline{CE}_2 on the CY7C196) and three-state drivers. They have an automatic power-down feature, reducing the power consumption by 75% when deselected.

Writing to the device is accomplished when the Chip Enable(s) (\overline{CE} on the CY7C194 and CY7C195, \overline{CE}_1 , \overline{CE}_2 on the CY7C196) and Write Enable (\overline{WE}) inputs are both LOW. Data on the four input pins (I/O_0 through I/O_3) is written into the memory location, specified on the address pins (A_0 through A_{15}).

Reading the device is accomplished by taking the Chip Enable(s) (\overline{CE} on the CY7C194 and CY7C195, \overline{CE}_1 , \overline{CE}_2 on the CY7C196) LOW, while Write Enable (\overline{WE}) remains HIGH. Under these conditions the contents of the memory location specified on the address pins will appear on the four data I/O pins.

A die coat is used to ensure alpha immunity.

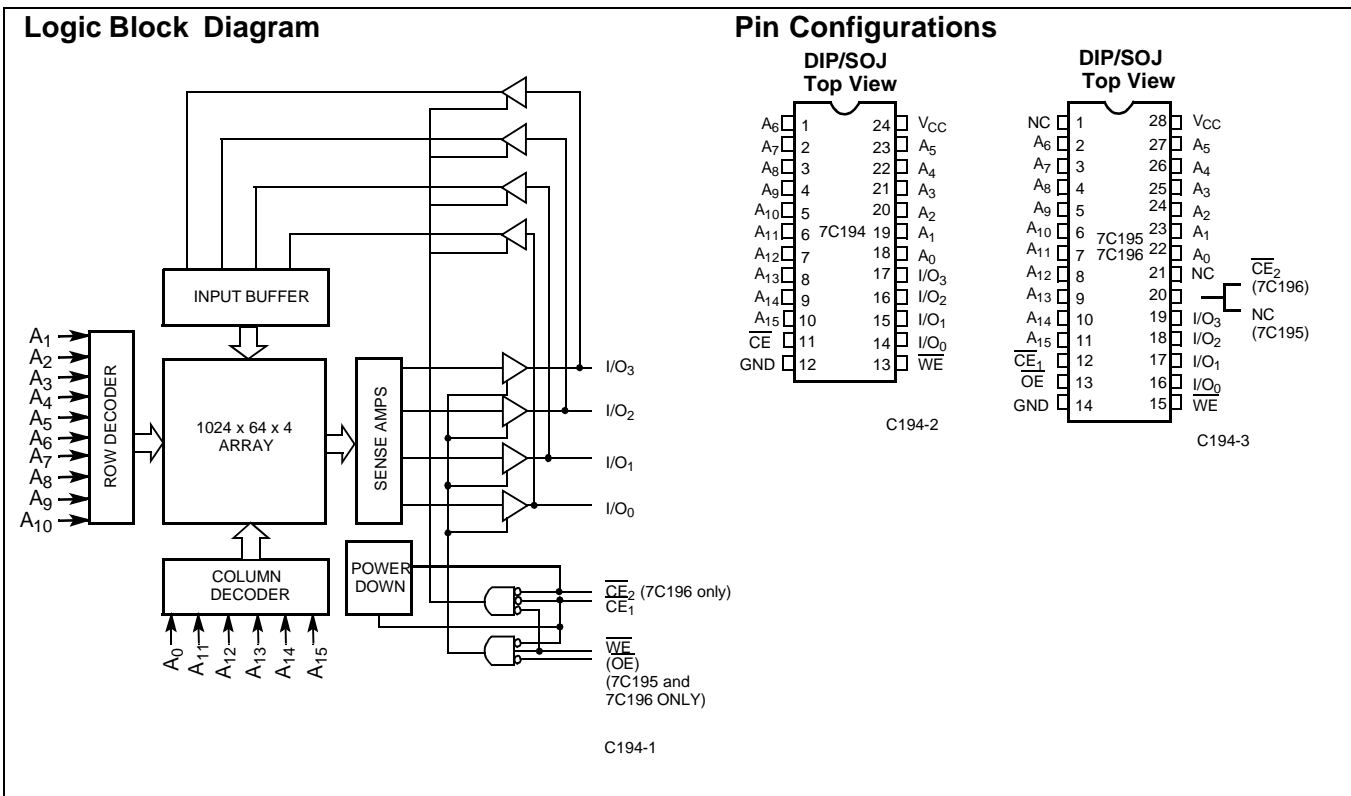

Selection Guide

	7C194-12 7C195-12 7C196-12	7C194-15 7C195-15 7C196-15	7C194-20 7C195-20 7C196-20	7C194-25 7C195-25 7C196-25	7C194-35 7C195-35 7C196-35	7C194-45 7C196-45
Maximum Access Time (ns)	12	15	20	25	35	45
Maximum Operating Current (mA)	155	145	135	115	115	
Maximum Standby Current (mA)	30	30	30	30	30	30



Maximum Ratings

(Above which the useful life may be impaired. For user guidelines, not tested.)

Storage Temperature -65°C to +150°C
 Ambient Temperature with Power Applied..... -55°C to +125°C
 Supply Voltage to Ground Potential -0.5V to +7.0V
 DC Voltage Applied to Outputs in High Z State^[1] -0.5V to V_{CC} + 0.5V
 DC Input Voltage^[1] -0.5V to V_{CC} + 0.5V

Output Current into Outputs (LOW)..... 20 mA
 Static Discharge Voltage >2001 V (per MIL-STD-883, Method 3015)
 Latch-Up Current..... >200 mA

Operating Range

Range	Ambient Temperature ^[2]	V _{CC}
Commercial	0°C to +70°C	5V ± 10%

Electrical Characteristics Over the Operating Range

Parameter	Description	Test Conditions	7C194-12 7C195-12 7C196-12		7C194-15 7C195-15 7C196-15		Unit
			Min.	Max.	Min.	Max.	
V _{OH}	Output HIGH Voltage	V _{CC} = Min., I _{OH} = -4.0 mA	2.4		2.4		V
V _{OL}	Output LOW Voltage	V _{CC} = Min., I _{OL} = 8.0 mA		0.4		0.4	V
V _{IH}	Input HIGH Voltage		2.2	V _{CC} + 0.3V	2.2	V _{CC} + 0.3V	V
V _{IL} ^[1]	Input LOW Voltage		-0.5	0.8	-0.5	0.8	V
I _{IX}	Input Load Current	GND ≤ V _I ≤ V _{CC}	-5	+5	-5	+5	μA
I _{OZ}	Output Leakage Current	GND ≤ V _O ≤ V _{CC} , Output Disabled	-5	+5	-5	+5	μA
I _{OS}	Output Short Circuit Current ^[3]	V _{CC} = Max., V _{OUT} = GND		-300		-300	mA
I _{CC}	V _{CC} Operating Supply Current	V _{CC} = Max., I _{OUT} = 0 mA, f = f _{MAX} = 1/t _{RC}		155		145	mA
I _{SB1}	Automatic \overline{CE} Power-Down Current —TTL Inputs ^[4]	Max. V _{CC} , $\overline{CE}_{1,2} \geq V_{IH}$, V _{IN} ≥ V _{IH} or V _{IN} ≤ V _{IL} , f = f _{MAX}		30		30	mA
I _{SB2}	Automatic \overline{CE} Power-Down Current —CMOS Inputs ^[4]	Max. V _{CC} , $\overline{CE}_{1,2} \geq V_{CC} - 0.3V$, V _{IN} ≥ V _{CC} - 0.3V or V _{IN} ≤ 0.3V, f = 0		10		10	mA

Notes:

1. Minimum voltage is equal to -2.0V for pulse durations of less than 20 ns.
2. T_A is the "Instant On" case temperature.
3. Not more than 1 output should be shorted at one time. Duration of the short circuit should not exceed 30 seconds.
4. A pull-up resistor to V_{CC} on the CE input is required to keep the device deselected during V_{CC} power-up, otherwise I_{SB} will exceed values given.

Electrical Characteristics Over the Operating Range (continued)

Parameter	Description	Test Conditions	7C194-20 7C195-20 7C196-20		7C194-25, 35, 45 7C195-25, 35 7C196-25, 35, 45		Unit
			Min.	Max.	Min.	Max.	
V _{OH}	Output HIGH Voltage	V _{CC} = Min., I _{OH} = -4.0 mA	2.4		2.4		V
V _{OL}	Output LOW Voltage	V _{CC} = Min., I _{OL} = 8.0 mA		0.4		0.4	V
V _{IH}	Input HIGH Voltage		2.2	V _{CC} + 0.3V	2.2	V _{CC} + 0.3V	V
V _{IL}	Input LOW Voltage		-0.5	0.8	-0.5	0.8	V
I _{IX}	Input Load Current	GND ≤ V _I ≤ V _{CC}	-5	+5	-5	+5	μA
I _{oZ}	Output Leakage Current	GND ≤ V _O ≤ V _{CC} , Output Disabled	-5	+5	-5	+5	μA
I _{OS}	Output Short Circuit Current ^[3]	V _{CC} = Max., V _{OUT} = GND		-300		-300	mA
I _{CC}	V _{CC} Operating Supply Current	V _{CC} = Max., I _{OUT} = 0 mA, f = f _{MAX} = 1/t _{RC}		135		115	mA
I _{SB1}	Automatic \overline{CE} Power-Down Current —TTL Inputs ^[4]	Max. V _{CC} , $\overline{CE}_{1,2} \geq V_{IH}$, V _{IN} ≥ V _{IH} or V _{IN} ≤ V _{IL} , f = f _{MAX}		30		30	mA
I _{SB2}	Automatic \overline{CE} Power-Down Current —CMOS Inputs ^[4]	Max. V _{CC} , $\overline{CE}_{1,2} \geq V_{CC} - 0.3V$, V _{IN} ≥ V _{CC} - 0.3V or V _{IN} ≤ 0.3V, f = 0		15		15	mA

Capacitance^[5]

Parameter	Description	Test Conditions	Max.	Unit
C _{IN}	Input Capacitance	T _A = 25°C, f = 1 MHz, V _{CC} = 5.0V	8	pF
C _{OUT}	Output Capacitance		10	pF

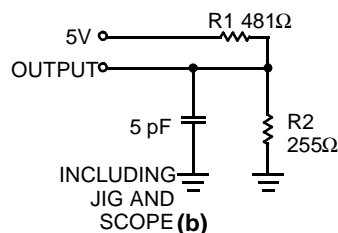
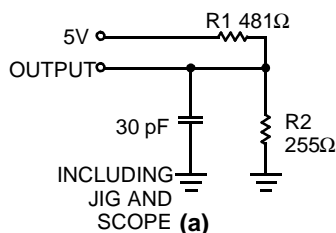
AC Test Loads and Waveforms^[6]

C194-4

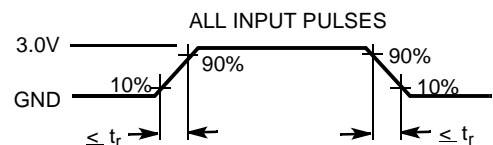

C194-5

Equivalent to: **THÉVENIN EQUIVALENT**
 167Ω
 OUTPUT $\text{---} \text{---} \text{---} 1.73V$

Notes:

- Tested initially and after any design or process changes that may affect these parameters.
- $t_r \leq 3$ ns for the -12 and -15 speeds. $T_r \leq 5$ ns for the -20 and slower speeds.

Switching Characteristics Over the Operating Range^[7]

Parameter	Description	7C194-12 7C195-12 7C196-12		7C194-15 7C195-15 7C196-15		7C194-20 7C195-20 7C196-20		7C194-25 7C195-25 7C196-25		7C194-35 7C195-35 7C196-35		7C194-45 7C196-45		Unit
		Min.	Max.	Min.	Max.	Min.	Max.	Min.	Max.	Min.	Max.	Min.	Max.	
READ CYCLE														
t _{RC}	Read Cycle Time	12		15		20		25		35		45		ns
t _{AA}	Address to Data Valid		12		15		20		25		35		45	ns
t _{OHA}	Output Hold from Address Change	3		3		3		3		3		3		ns
t _{ACE1} , t _{ACE2}	\overline{CE} LOW to Data Valid		12		15		20		25		35		45	ns
t _{DOE}	\overline{OE} LOW to Data Valid		5		7		9		10		16		16	ns
t _{LZOE}	\overline{OE} LOW to Low Z		0		0		0		3		3		3	ns
t _{HZOE}	\overline{OE} HIGH to High Z ^[8]		5		7		9		11		15		15	ns
t _{LZCE1} , t _{LZCE2}	\overline{CE} LOW to Low Z ^[8]	3		3		3		3		3		3		ns
t _{HZCE1} , t _{HZCE2}	\overline{CE} HIGH to High Z ^[8,8]		5		7		9		11		15		15	ns
t _{PU}	\overline{CE} LOW to Power-Up	0		0		0		0		0		0		ns
t _{PD}	\overline{CE} HIGH to Power-Down		12		15		20		25		35		45	ns
WRITE CYCLE^[10]														
t _{WC}	Write Cycle Time	12		15		20		25		35		45		ns
t _{SCE}	\overline{CE} LOW to Write End	9		10		15		18		22		22		ns
t _{AW}	Address Set-Up to Write End	9		10		15		20		25		35		ns
t _{HA}	Address Hold from Write End	0		0		0		0		0		0		ns
t _{SA}	Address Set-Up to Write Start	0		0		0		0		0		0		ns
t _{PWE}	\overline{WE} Pulse Width	8		9		15		18		22		22		ns
t _{SD}	Data Set-Up to Write End	8		9		10		10		15		15		ns
t _{HD}	Data Hold from Write End	0		0		0		0		0		0		ns
t _{LZWE}	\overline{WE} HIGH to Low Z ^[8]	3		3		3		3		3		3		ns
t _{HZWE}	\overline{WE} LOW to High Z ^[8,9]		7		7		10		13		15		20	ns

Notes:

- Test conditions assume signal transition time of 3 ns or less for -12 and -15 speeds and 5 ns or less for -20 and slower speeds, timing reference levels of 1.5V, input pulse levels of 0 to 3.0V, and output loading of the specified I_{OL}/I_{OH} and 30-pF load capacitance.
- t_{HZOE}, t_{HZCE}, and t_{HZWE} are specified with C_L = 5 pF as in part (b) of AC Test Loads. Transition is measured ±500 mV from steady-state voltage.
- At any given temperature and voltage condition, t_{HZCE} is less than t_{LZCE} and t_{HZWE} is less than t_{LZWE} for any given device.
- The internal write time of the memory is defined by the overlap of \overline{CE}_1 LOW, \overline{CE}_2 LOW, and \overline{WE} LOW. All signals must be LOW to initiate a write and any signal can terminate a write by going HIGH. The data input set-up and hold timing should be referenced to the rising edge of the signal that terminates the write.

Switching Waveforms

Read Cycle No. 1 [11, 12]

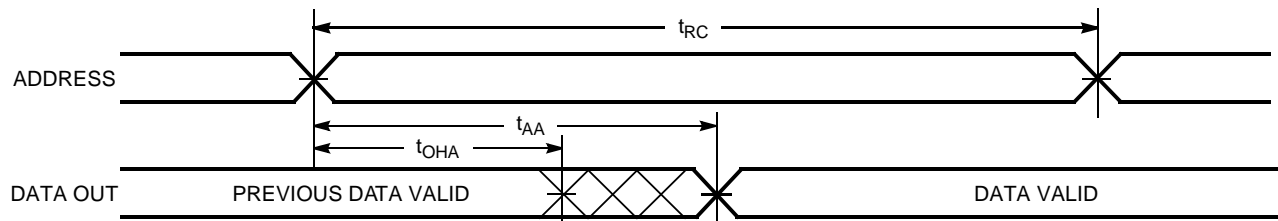

C194-8

Read Cycle No. 2 [11, 13]

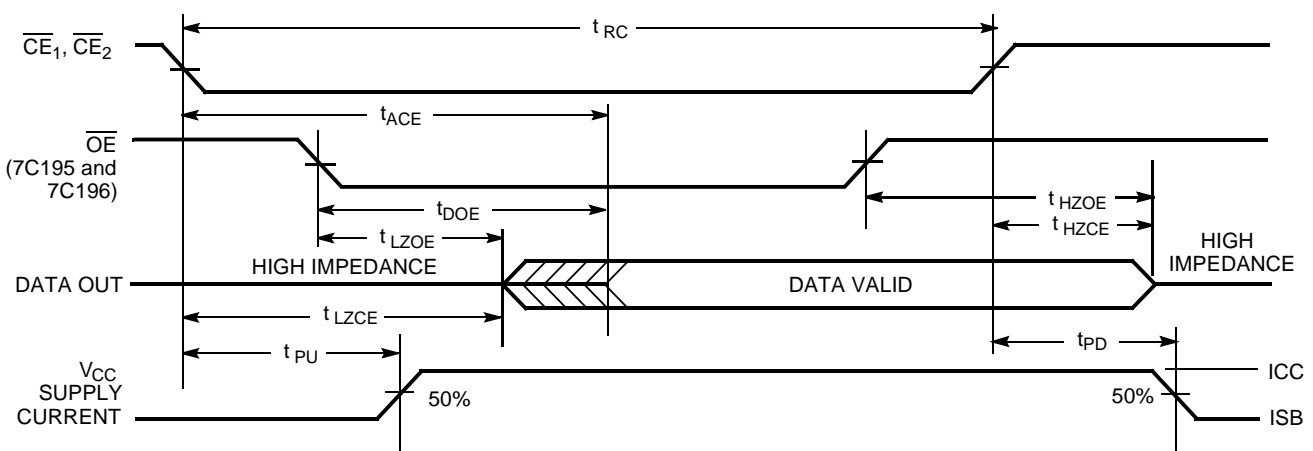

C194-6

Write Cycle No. 1 (CE Controlled) [10, 14, 15]

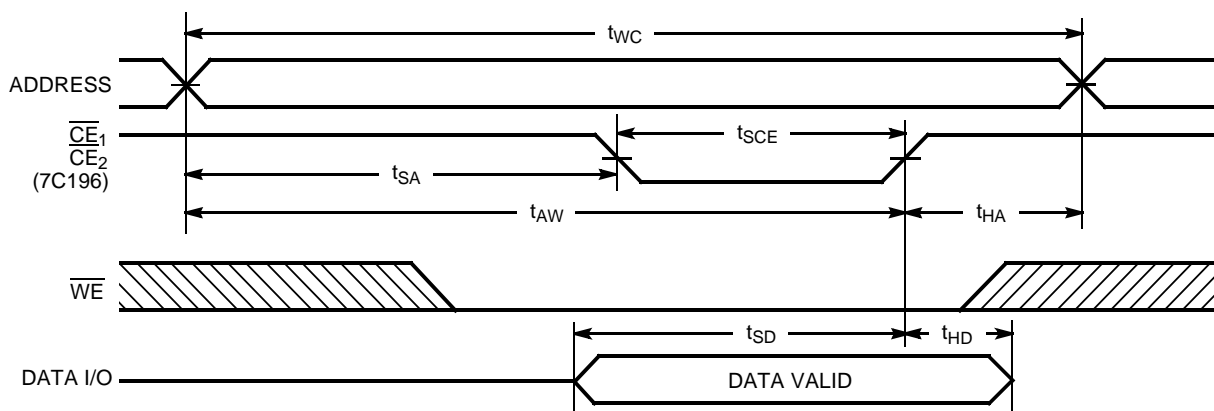

C194-7

Notes:

11. \overline{WE} is HIGH for read cycle.
12. Device is continuously selected: $\overline{CE}_1 = V_{IL}$, $\overline{CE}_2 = V_{IL}$ (7C196), and $\overline{OE} = V_{IL}$ (7C195 and 7C196).
13. Address valid prior to or coincident with \overline{CE}_1 and \overline{CE}_2 transition LOW.
14. Data I/O will be high impedance if $\overline{OE} = V_{IH}$ (7C195 and 7C196).
15. If any CE goes HIGH simultaneously with WE HIGH, the output remains in a high-impedance state.

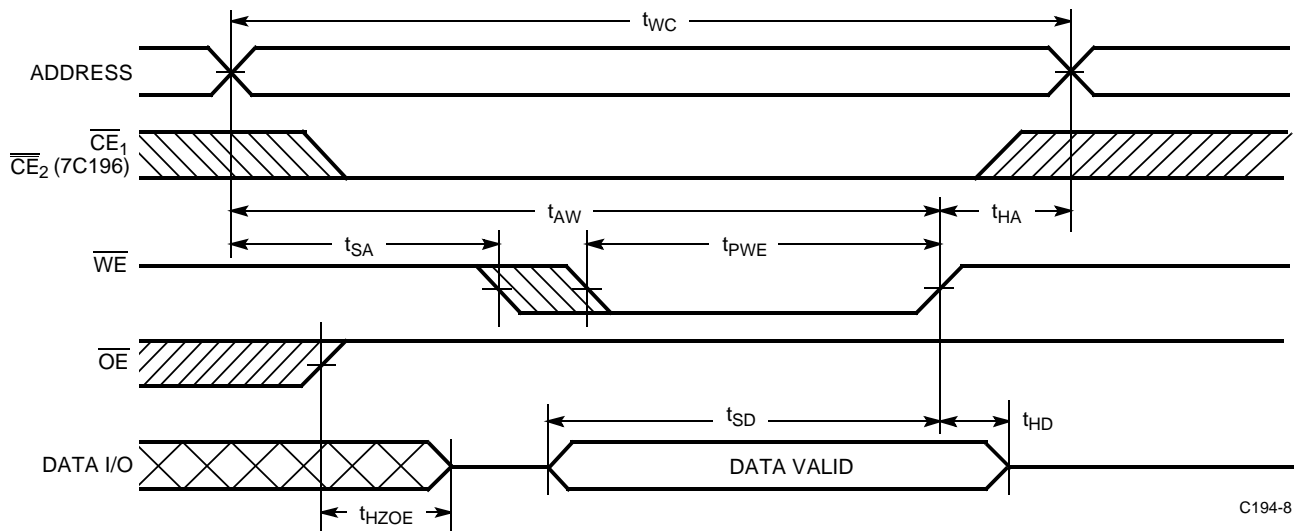
Switching Waveforms (continued)
Write Cycle No. 2 (\overline{WE} Controlled, \overline{OE} HIGH During Write for 7C195 and 7C196 only) ^[10, 14, 15]

C194-8

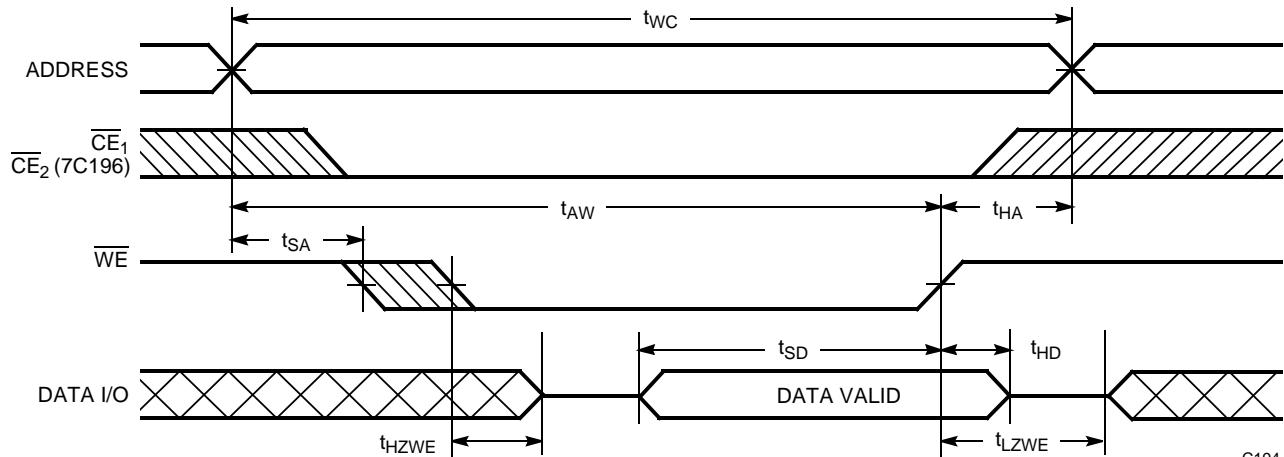
Write Cycle No. 3 (\overline{WE} Controlled, \overline{OE} LOW) ^[15, 16]

C194-9

Note:

 16. The minimum write cycle time for Write Cycle No. 3 (\overline{WE} controlled, \overline{OE} LOW) is the sum of t_{HZWE} and t_{SD} .

Typical DC and AC Characteristics

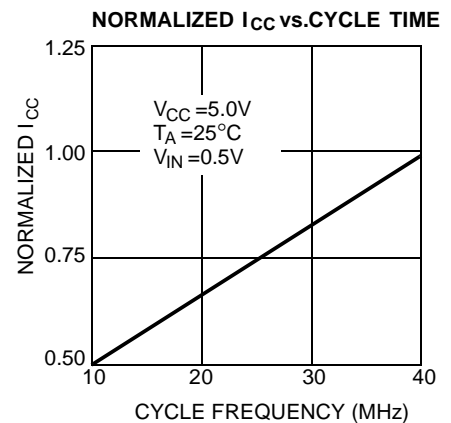
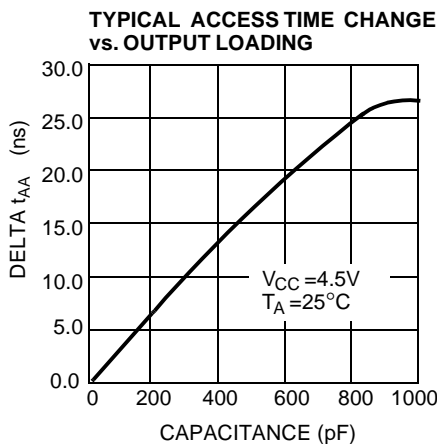
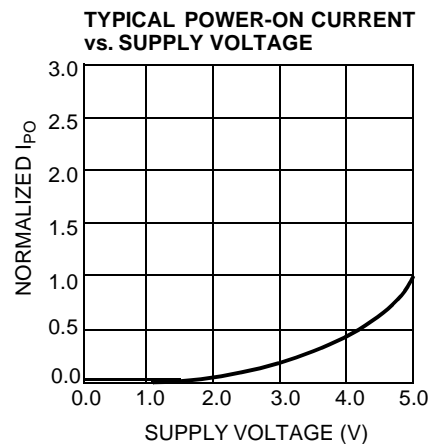
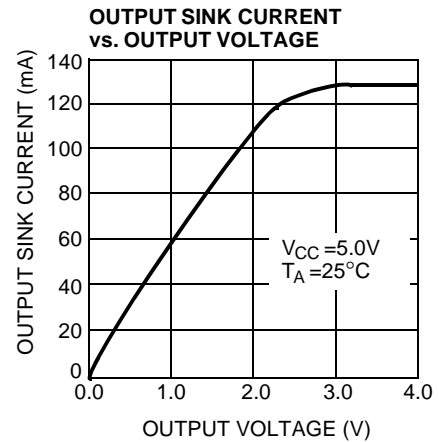
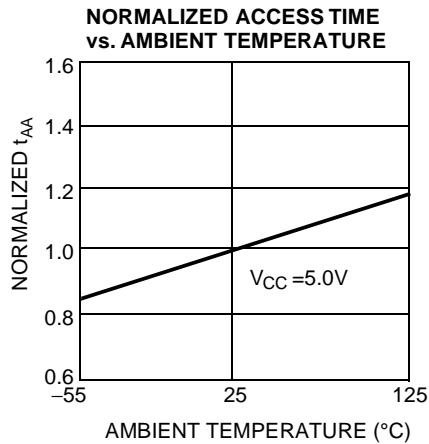
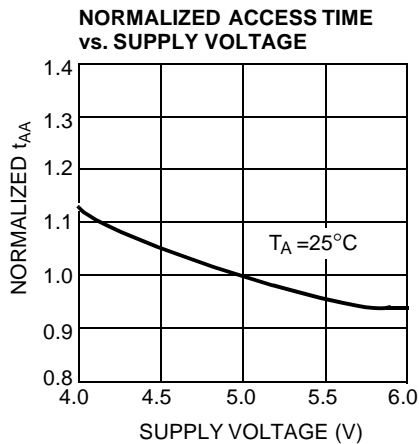
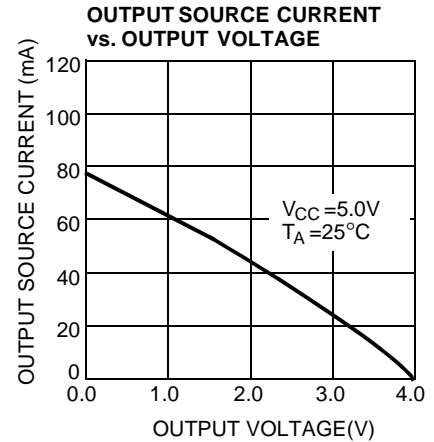
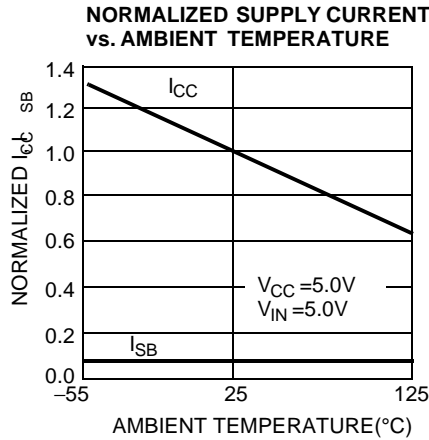
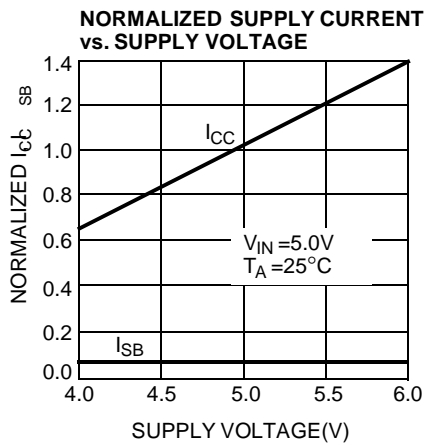

7C194 Truth Table

CE	WE	Data I/O	Mode	Power
H	X	High Z	Deselect/Power-Down	Standby (I_{SB})
L	H	Data Out	Read	Active (I_{CC})
L	L	Data In	Write	Active (I_{CC})

7C195 Truth Table

CE₁	WE	OE	Data I/O	Mode	Power
H	X	X	High Z	Deselect/Power-Down	Standby (I_{SB})
L	H	L	Data Out	Read	Active (I_{CC})
L	L	X	Data In	Write	Active (I_{CC})
L	H	H	High Z	Deselect	Active (I_{CC})

7C196 Truth Table

CE₁	CE₂	WE	OE	Data I/O	Mode	Power
H	X	X	X	High Z	Deselect/Power-Down	Standby (I_{SB})
X	H	X	X			
L	L	H	L	Data Out	Read	Active (I_{CC})
L	L	L	X	Data In	Write	Active (I_{CC})
L	L	H	H	High Z	Deselect	Active (I_{CC})



Ordering Information

Speed (ns)	Ordering Code	Package Name	Package Type	Operating Range
12	CY7C194-12PC	P13	24-Lead (300-Mil) Molded DIP	Commercial
	CY7C194-12VC	V13	24-Lead Molded SOJ	
15	CY7C194-15PC	P13	24-Lead (300-Mil) Molded DIP	Commercial
	CY7C194-15VC	V13	24-Lead Molded SOJ	
20	CY7C194-20PC	P13	24-Lead (300-Mil) Molded DIP	Commercial
	CY7C194-20VC	V13	24-Lead Molded SOJ	
25	CY7C194-25PC	P13	24-Lead (300-Mil) Molded DIP	Commercial
	CY7C194-25VC	V13	24-Lead Molded SOJ	
35	CY7C194-35PC	P13	24-Lead (300-Mil) Molded DIP	Commercial
	CY7C194-35VC	V13	24-Lead Molded SOJ	
45	CY7C194-45PC	P13	24-Lead (300-Mil) Molded DIP	Commercial
	CY7C194-45VC	V13	24-Lead Molded SOJ	

Speed (ns)	Ordering Code	Package Name	Package Type	Operating Range
12	CY7C195-12PC	P21	28-Lead (300-Mil) Molded DIP	Commercial
	CY7C195-12VC	V21	28-Lead Molded SOJ	
15	CY7C195-15PC	P21	28-Lead (300-Mil) Molded DIP	Commercial
	CY7C195-15VC	V21	28-Lead Molded SOJ	
20	CY7C195-20PC	P21	28-Lead (300-Mil) Molded DIP	Commercial
	CY7C195-20VC	V21	28-Lead Molded SOJ	
25	CY7C195-25PC	P21	28-Lead (300-Mil) Molded DIP	Commercial
	CY7C195-25VC	V21	28-Lead Molded SOJ	
35	CY7C195-35PC	P21	28-Lead (300-Mil) Molded DIP	Commercial
	CY7C195-35VC	V21	28-Lead Molded SOJ	
45	CY7C195-45PC	P21	28-Lead (300-Mil) Molded DIP	Commercial
	CY7C195-45VC	V21	28-Lead Molded SOJ	

Speed (ns)	Ordering Code	Package Name	Package Type	Operating Range
12	CY7C196-12PC	P21	28-Lead (300-Mil) Molded DIP	Commercial
	CY7C196-12VC	V21	28-Lead Molded SOJ	
15	CY7C196-15PC	P21	28-Lead (300-Mil) Molded DIP	Commercial
	CY7C196-15VC	V21	28-Lead Molded SOJ	
20	CY7C196-20PC	P21	28-Lead (300-Mil) Molded DIP	Commercial
	CY7C196-20VC	V21	28-Lead Molded SOJ	
25	CY7C196-25PC	P21	28-Lead (300-Mil) Molded DIP	Commercial
	CY7C196-25VC	V21	28-Lead Molded SOJ	
35	CY7C196-35PC	P21	28-Lead (300-Mil) Molded DIP	Commercial
	CY7C196-35VC	V21	28-Lead Molded SOJ	

Package Diagrams
24-Lead (300-Mil) Molded DIP P13/P13A

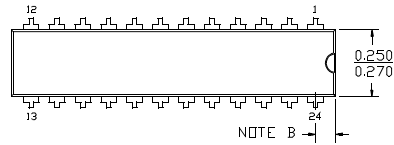
 DIMENSIONS IN INCHES MIN.
MAX.

	P 13	P 13A
NOTE A	1.170 1.200	1.230 1.260
NOTE B	0.030 0.050	0.060 0.080

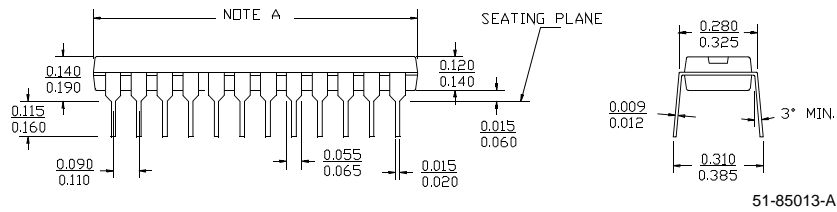
28-Lead (300-Mil) Molded DIP P21

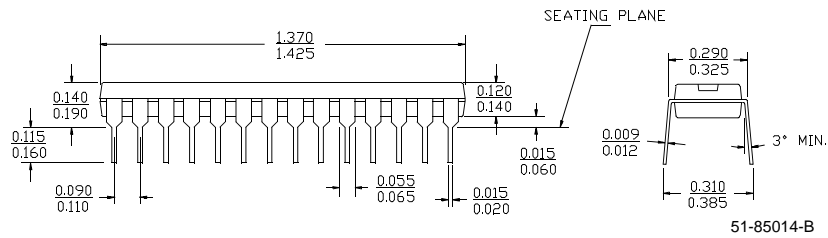
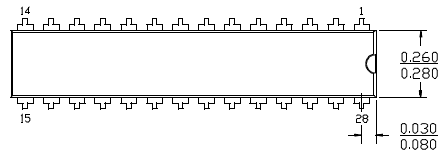
 DIMENSIONS IN INCHES MIN.
MAX.

Package Diagrams (continued)

24-Lead (300-Mil) Molded SOJ V13

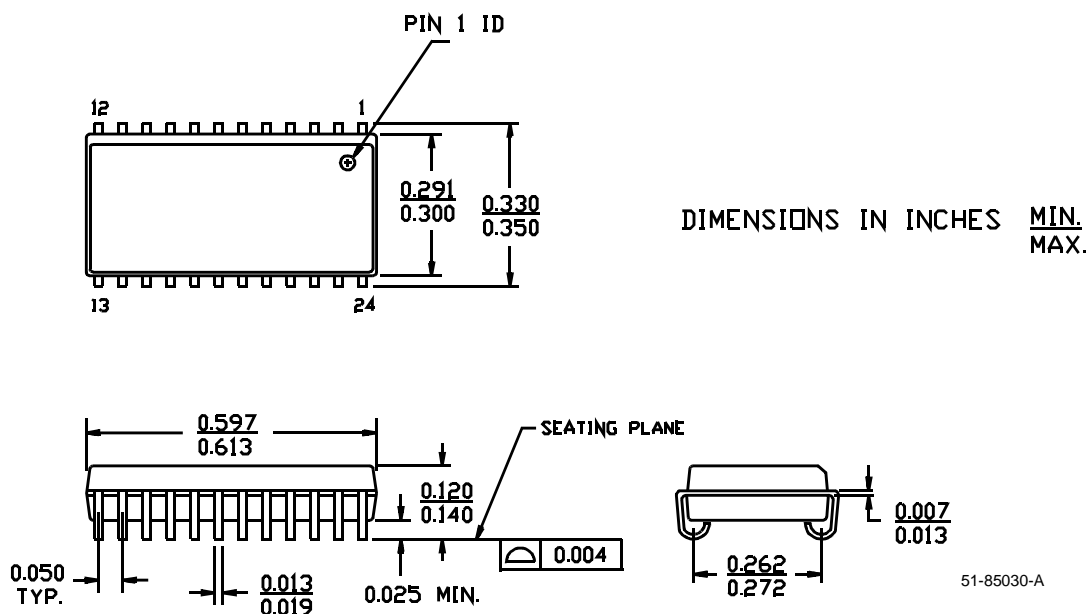

28-Lead (300-Mil) Molded SOJ V21

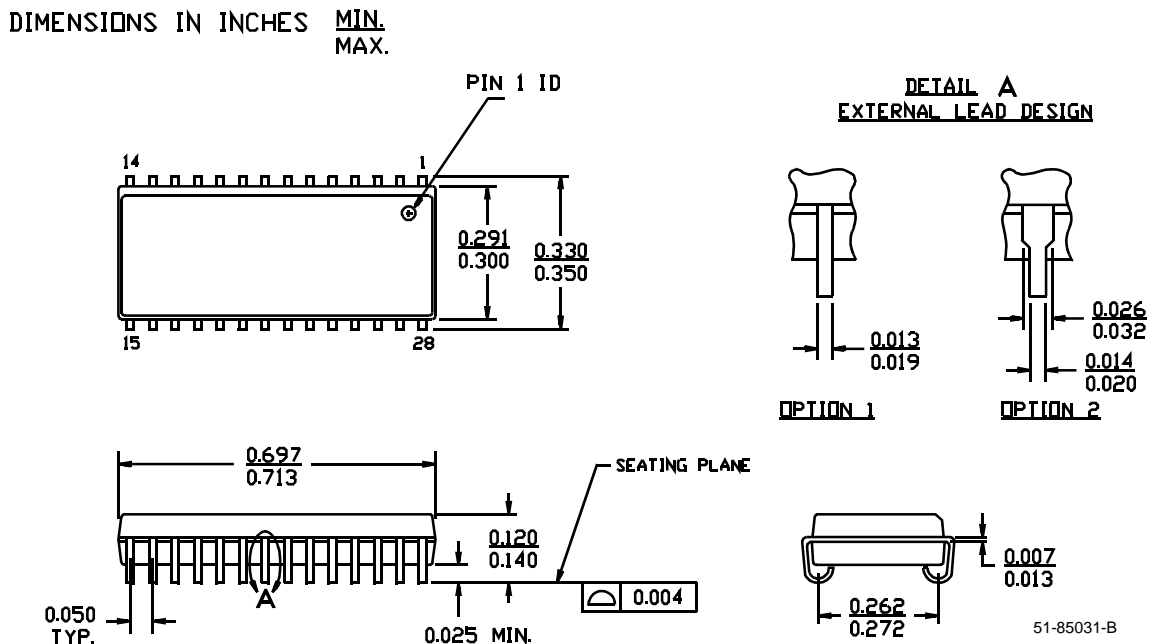



Document Title: CY7C194/CY7C195/CY7C196 64K x 4 Static RAM Document Number: 38-05162				
REV.	ECN NO.	Issue Date	Orig. of Change	Description of Change
**	110172	09/29/01	SZV	Change from Spec number: 38-00081 to 38-05162