

NEW Product

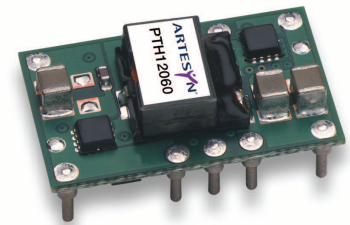

- 10 A output current
- 12 V input voltage
- Wide-output voltage adjust
  - 1.2 Vdc to 5.5 Vdc for suffix 'W' and 0.8 Vdc to 1.8 Vdc for suffix 'L'
- Auto-track™ sequencing\*
- Margin up/down controls
- Efficiencies up to 94%
- Output ON/OFF inhibit
- Output voltage sense
- Point-of-Load-Alliance (POLA) compatible
- Available RoHS compliant



The PTH12060 is a next generation series of non-isolated dc-dc converters offering some of the most advanced POL features available in the industry. The primary new feature provides for sequencing between multiple modules, a function, which is becoming a necessity for powering advanced silicon including DSP's, FPGA's and ASIC's requiring controlled power-up and power-down. Other industry leading features include margin up/down controls and efficiencies up to 94%. The PTH12060 has an input voltage of 10.8 Vdc to 13.2 Vdc and offers a wide output voltage range adjustable with external trim resistor, allowing for maximum design flexibility and a pathway for future upgrades.



2 YEAR WARRANTY

All specifications are typical at nominal input, full load at 25 °C unless otherwise stated  
 $C_{in} = 560 \mu F$ ,  $C_{out} = 0 \mu F$

## SPECIFICATIONS

### OUTPUT SPECIFICATIONS

Voltage adjustability (See Note 4)	Suffix 'W' Suffix 'L'	1.2-5.5 Vdc 0.8-1.8 Vdc
Setpoint accuracy		±2.0% $V_o$
Line regulation		±10 mV typ.
Load regulation		±12 mV typ.
Total regulation		±3.0% $V_o$
Minimum load		0 A
Ripple and noise 20 MHz bandwidth (See Note 8)	Suffix 'W' Suffix 'L'	$V_o > 2.5 V$ 25 mV pk-pk $V_o > 2.5 V$ 1% $V_o$ $V_o > 1.0 V$ 20 mV pk-pk $V_o > 1.0 V$ 30 mV pk-pk
Temperature co-efficient	-40 °C to +85 °C	±0.5% $V_o$
Transient response (See Note 5)		70 $\mu s$ recovery time Overshoot/undershoot 100 mV
Margin adjustment		±5.0% $V_o$

### INPUT SPECIFICATIONS

Input voltage range	(See Note 3)	10.8-13.2 Vdc
Input current	No load	10 mA typ.
Remote ON/OFF	(See Note 1)	Positive logic
Start-up time		1 V/ms
Undervoltage lockout		9.0-9.5 V typ.
Track input voltage	Pin 8 (See Note 6)	±0.3 $V_{in}$

### EMC CHARACTERISTICS

Electrostatic discharge	EN61000-4-2, IEC801-2
Conducted immunity	EN61000-4-6
Radiated immunity	EN61000-4-3

### GENERAL SPECIFICATIONS

Efficiency	See Tables on page 2	
Insulation voltage	Non-isolated	
Switching frequency Over $V_{in}$ and $I_o$ ranges	Suffix 'W' Suffix 'L'	350 kHz typ. 250 kHz typ.
Approvals and standards	EN60950 UL/cUL60950	
Material flammability	UL94V-0	
Dimensions	(L x W x H)	25.27 x 15.75 x 9.00 mm 0.995 x 0.620 x 0.354 in
Weight	5 g (0.18 oz)	
MTBF	Telcordia SR-332	7,092,000 hours

### ENVIRONMENTAL SPECIFICATIONS

Thermal performance (See Note 2)	Operating ambient, temperature Non-operating	-40 °C to +85 °C -40 °C to +125 °C
MSL ('Z' suffix only)	JEDEC J-STD-020C	Level 3

### PROTECTION

Short-circuit	Auto reset	20 A typ.
---------------	------------	-----------

### International Safety Standard Approvals



UL/cUL CAN/CSA-C22.2 No. 60950-1-03/UL 60950-1, File No. E174104



TÜV Product Service (EN60950) Certificate No. B 04 06 38572 044  
 CB Report and Certificate to IEC60950, Certificate No. US/8292/UL

\*Auto-track™ is a trade mark of Texas Instruments

OUTPUT POWER (MAX.)	INPUT VOLTAGE	OUTPUT VOLTAGE	OUTPUT CURRENT (MIN.)	OUTPUT CURRENT (MAX.)	EFFICIENCY (MAX.)	REGULATION		MODEL NUMBER
						LINE	LOAD	
55 W	10.8-13.2 Vdc	0.8-1.8 Vdc	0 A	10 A	88%	±10 mV	±12 mV	PTH12060L
55 W	10.8-13.2 Vdc	1.2-5.5 Vdc	0 A	10 A	94%	±10 mV	±12 mV	PTH12060W

Part Number System with Options

**PTH12060WAST**

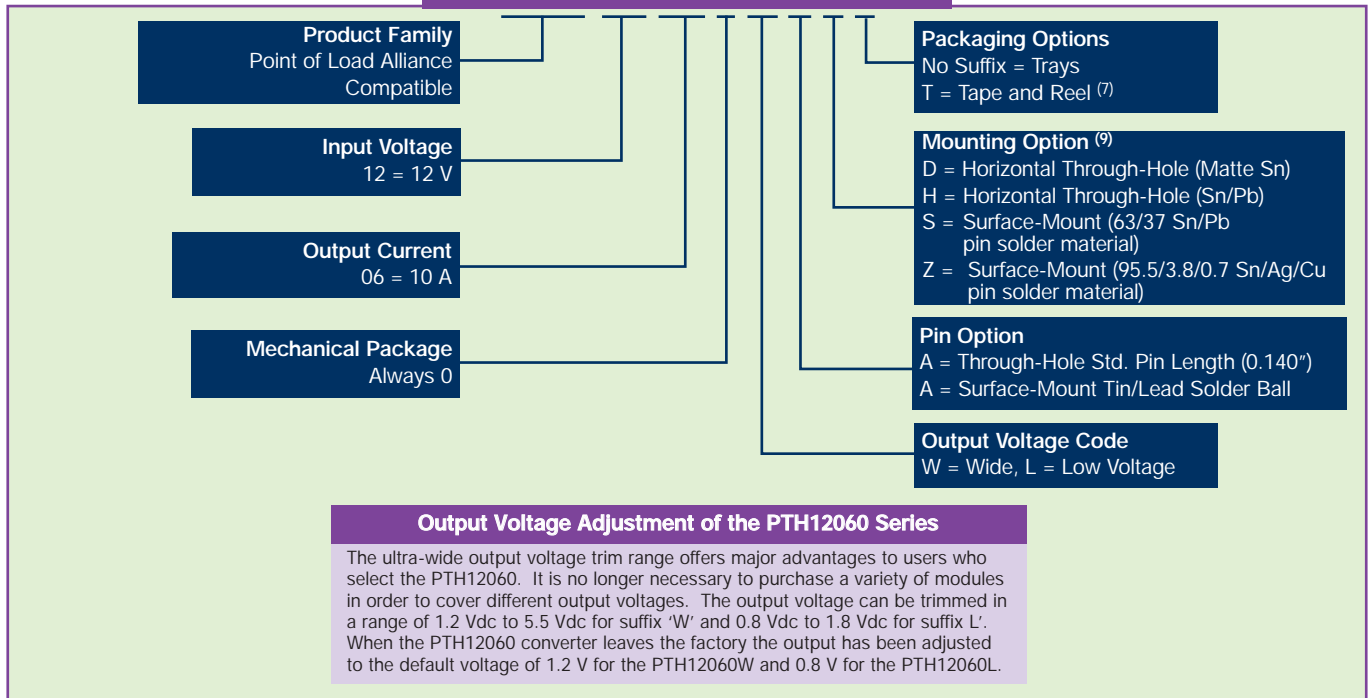

**Notes**

- Remote ON/OFF. Active High  
ON: Pin 3 open; or  $V > V_{in} - 0.5 V$   
OFF: Pin 3 GND; or  $V < 0.8 V$  (min - 0.2 V).
- See Figures 1, 2 and 3 for safe operating curves of PTH12060W and Figures 6, 7 and 8 for safe operating curves of PTH12060L.
- A 560  $\mu F$  electrolytic input capacitor is required for proper operation. The capacitor must be rated for a minimum of 800 mA rms of ripple current.
- An external output capacitor is not required for basic operation. Adding 330  $\mu F$  of distributed capacitance at the load will improve the transient response.
- 1 A/ $\mu s$  load step, 50 to 100%  $I_{Omax}$ ,  $C_{out} = 330 \mu F$ .
- If utilized  $V_{out}$  will track applied voltage by  $\pm 0.3 V$  (up to  $V_o$  set point).
- Tape and reel packaging only available on the surface-mount versions.
- The pk-pk output ripple voltage is measured with an external 10 $\mu F$  ceramic capacitor. See Figures 5 and 8 for Standard application schematic.
- To order Pb-free (RoHS compatible) surface-mount parts replace the mounting option 'S' with 'Z', e.g. PTH12060WAZ. To order Pb-free (RoHS compatible) through-hole parts replace the mounting option 'H' with 'D', e.g. PTH12060WAD.

**EFFICIENCY TABLE - PTH12060W ( $I_o = 8 A$ )**

OUTPUT VOLTAGE	EFFICIENCY
$V_o = 5.0 V$	94%
$V_o = 3.3 V$	92%
$V_o = 2.5 V$	90%
$V_o = 2.0 V$	88%
$V_o = 1.8 V$	87%
$V_o = 1.5 V$	85%
$V_o = 1.2 V$	83%

**EFFICIENCY TABLE - PTH12060L ( $I_o = 8 A$ )**

OUTPUT VOLTAGE	EFFICIENCY
$V_o = 1.8 V$	88%
$V_o = 1.5 V$	87%
$V_o = 1.2 V$	84%
$V_o = 1.0 V$	82%
$V_o = 0.8 V$	79%

PTH12060W Characteristic Data

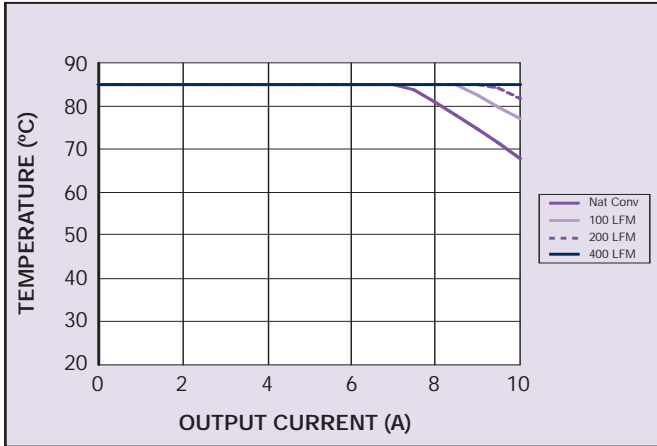

Figure 1 - Safe Operating Area for PTH12060W  
Vin = 12 V, Output Voltage = 5 V (See Note A)

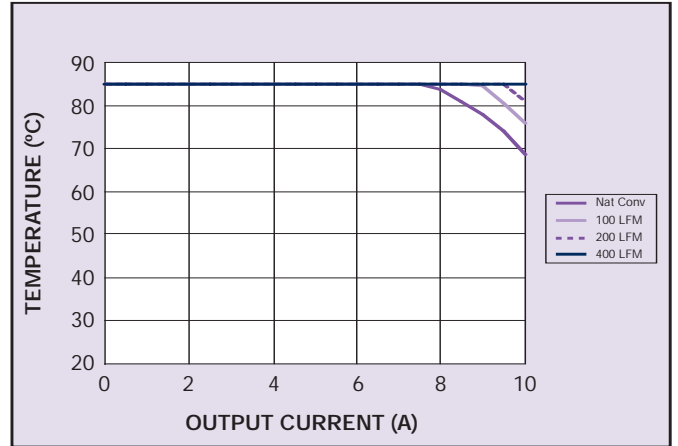

Figure 2 - Safe Operating Area for PTH12060W  
Vin = 12 V, Output Voltage = 3.3 V (See Note A)

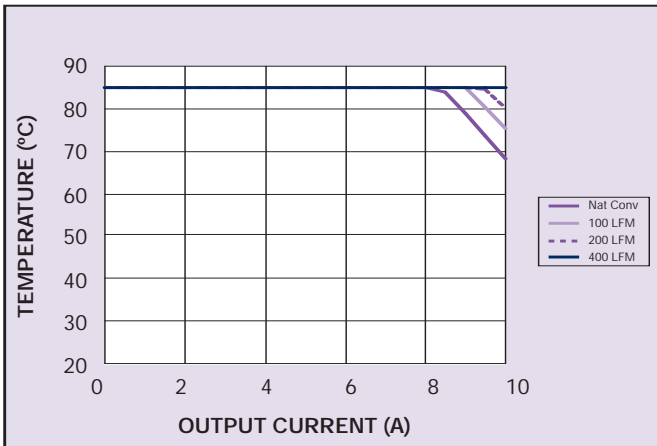

Figure 3 - Safe Operating Area for PTH12060W  
Vin = 12 V, Output Voltage = 1.8 V (See Note A)

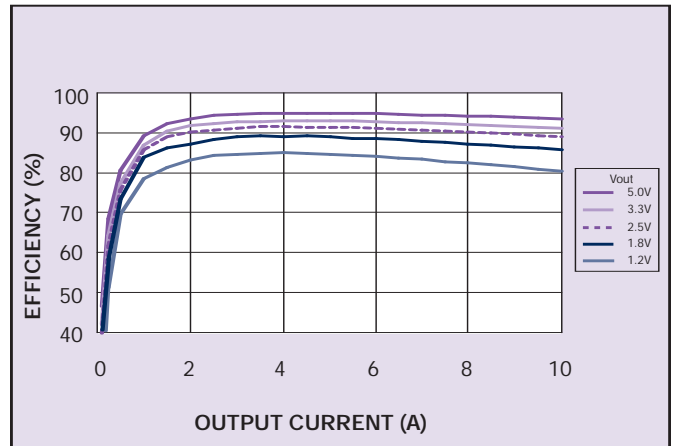

Figure 4 - Efficiency vs Load Current for PTH12060W  
Vin = 12 V (See Note B)

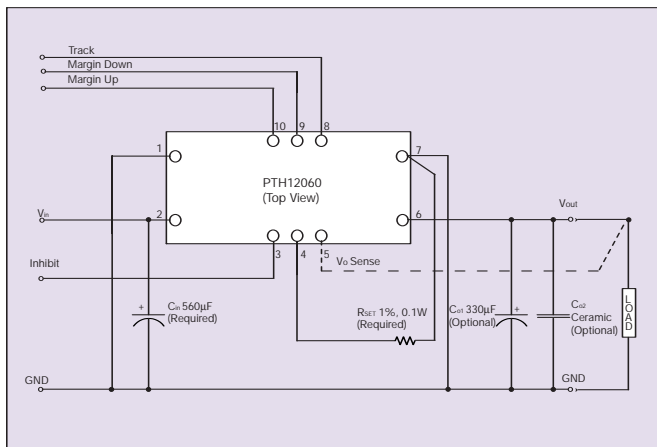

Figure 5 - Standard Application - All Models

**Notes**

- A SOA curves represent the conditions at which internal components are within the Artesyn derating guidelines.
- B Characteristic data has been developed from actual products tested at 25 °C. This data is considered typical data for the converter.

PTH12060L Characteristic Data

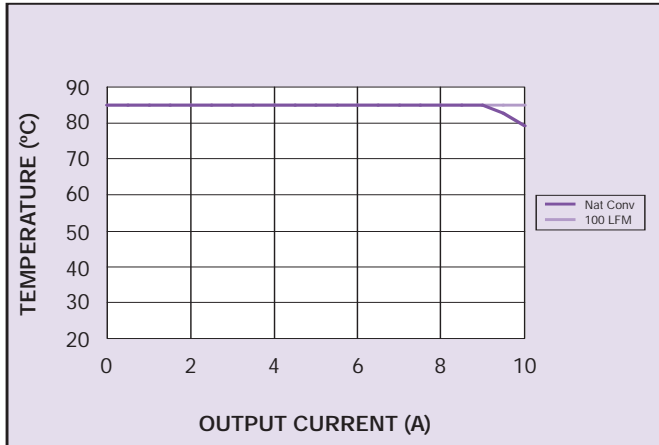

Figure 6 - Safe Operating Area for PTH12060L  
Vin = 12 V, Output Voltage = 1.8 V (See Note A)

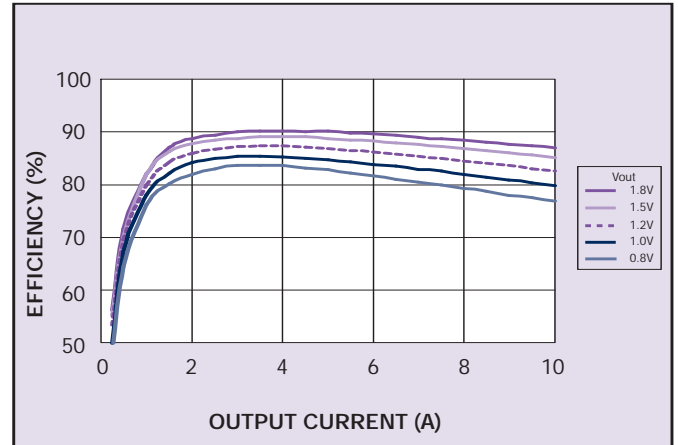

Figure 7 - Efficiency vs Load Current for PTH12060L  
Vin = 12 V (See Note B)

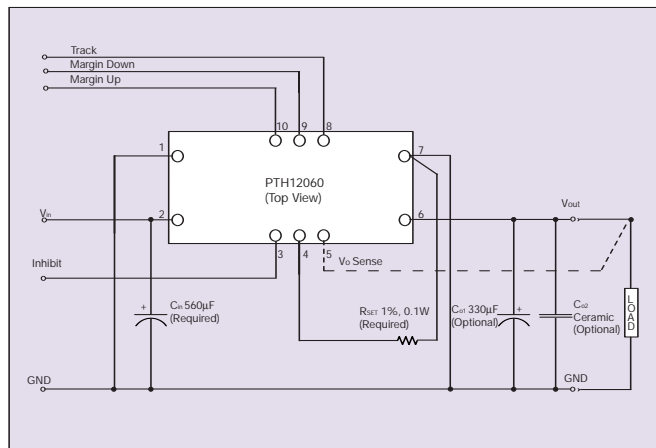

Figure 8 - Standard Application - All Models

Notes

- A SOA curves represent the conditions at which internal components are within the Artesyn derating guidelines.
- B Characteristic data has been developed from actual products tested at 25 °C. This data is considered typical data for the converter.

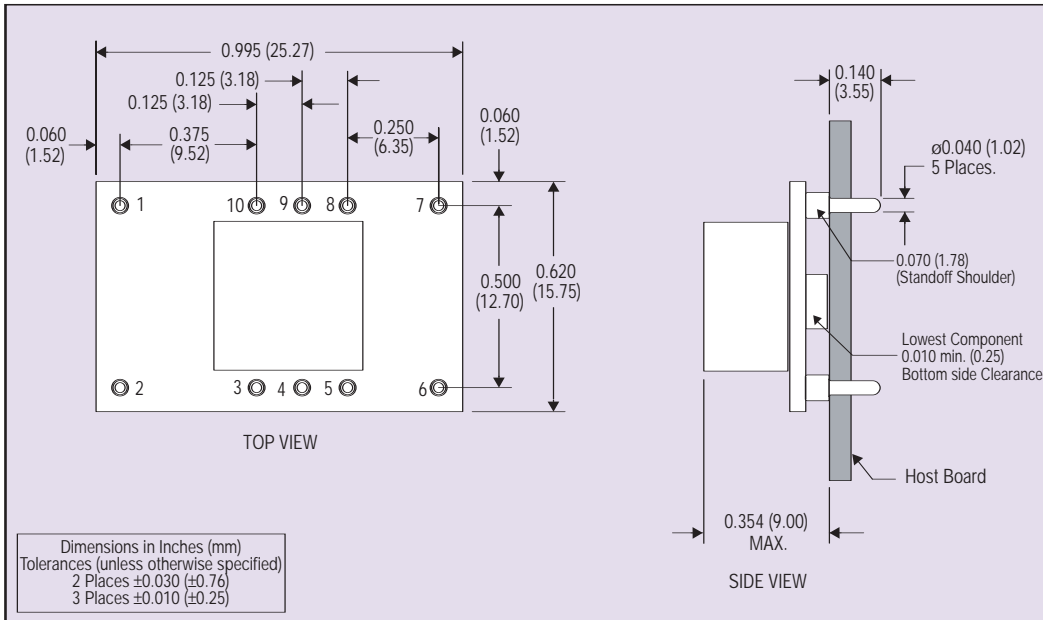

Figure 9 - Plated Through-Hole Mechanical Drawing

PIN CONNECTIONS	
PIN NO.	FUNCTION
1	Ground
2	Vin
3	Inhibit*
4	Vo adjust
5	Vo sense
6	Vout
7	Ground
8	Track
9	Margin down*
10	Margin up*

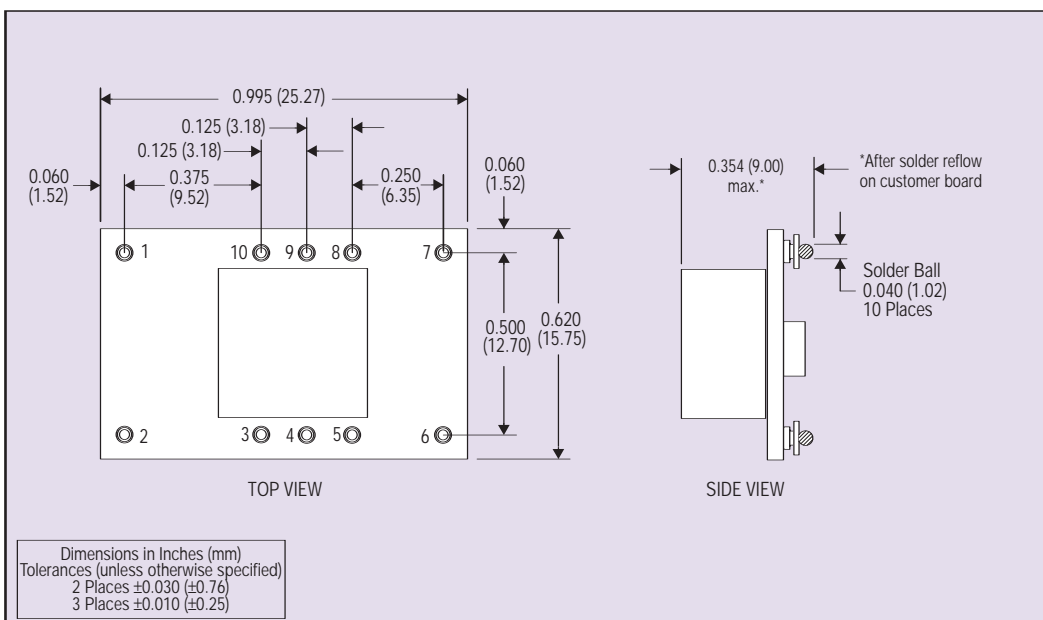

Figure 10 - Surface-Mount Mechanical Drawing

\*Denotes negative logic:  
Open = Normal operation  
Ground = Function active