



# STD90NH02L STD90NH02L-1

N-channel 24V - 0.0052Ω - 60A - DPAK/IPAK  
STripFET™ II Power MOSFET

## General features

Type	V <sub>DSS</sub>	R <sub>DS(on)</sub>	I <sub>D</sub>
STD90NH02L-1	24V	<0.006Ω	60A <sup>(1)</sup>
STD90NH02L	24V	<0.006Ω	60A <sup>(1)</sup>

1. Value limited by wire bonding

- R<sub>DS(ON)</sub> \* Q<sub>g</sub> industry's benchmark
- Conduction losses reduced
- Switching losses reduced
- Low threshold device

## Description

The device utilizes the latest advanced design rules of ST's proprietary STripFET™ technology. This is suitable for the most demanding DC-DC converter application where high efficiency is to be achieved.

## Applications

- Switching application

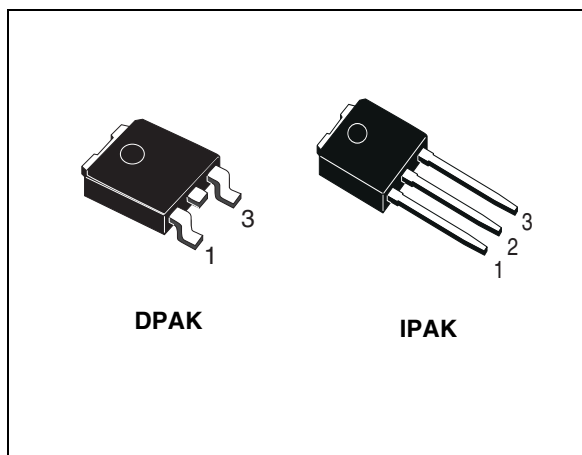

## Internal schematic diagram

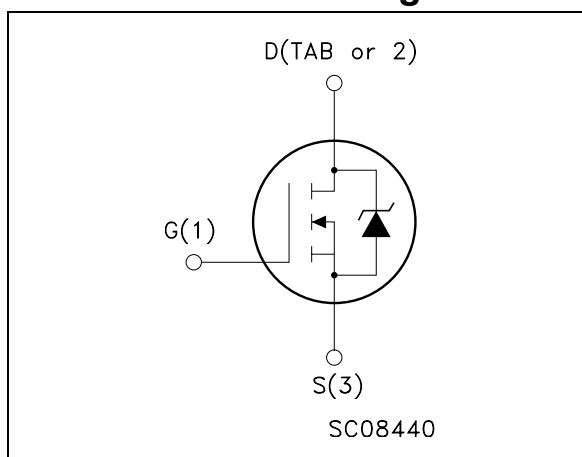

## Order codes

Part number	Marking	Package	Packaging
STD90NH02LT4	D90NH02L	DPAK	Tape & reel
STD90NH02L-1	D90NH02L	IPAK	Tube

---

# Contents

<b>1</b>	<b>Electrical ratings</b> .....	<b>3</b>
<b>2</b>	<b>Electrical characteristics</b> .....	<b>4</b>
	2.1 Electrical characteristics (curves) .....	6
<b>3</b>	<b>Test circuit</b> .....	<b>8</b>
<b>4</b>	<b>Appendix A</b> .....	<b>9</b>
<b>5</b>	<b>Package mechanical data</b> .....	<b>11</b>
<b>6</b>	<b>Packing mechanical data</b> .....	<b>14</b>
<b>7</b>	<b>Revision history</b> .....	<b>15</b>

# 1 Electrical ratings

**Table 1. Absolute maximum ratings**

Symbol	Parameter	Value	Unit
$V_{\text{spike}}^{(1)}$	Drain-source voltage rating	30	V
$V_{\text{DS}}$	Drain-source voltage ( $V_{\text{GS}} = 0$ )	24	V
$V_{\text{DGR}}$	Drain-gate voltage ( $R_{\text{GS}} = 20\text{k}\Omega$ )	24	V
$V_{\text{GS}}$	Gate-source voltage	$\pm 20$	V
$I_{\text{D}}^{(2)}$	Drain current (continuous) at $T_{\text{C}} = 25^{\circ}\text{C}$	60	A
$I_{\text{D}}^{(2)}$	Drain current (continuous) at $T_{\text{C}} = 100^{\circ}\text{C}$	60	A
$I_{\text{DM}}^{(3)}$	Drain current (pulsed)	240	A
$P_{\text{TOT}}$	Total dissipation at $T_{\text{C}} = 25^{\circ}\text{C}$	95	W
	Derating factor	0.63	W/ $^{\circ}\text{C}$
$E_{\text{AS}}^{(4)}$	Single pulse avalanche energy	600	mJ
$T_{\text{j}}$ $T_{\text{stg}}$	Operating junction temperature storage temperature	-55 to 175	$^{\circ}\text{C}$

1. Guaranteed when external  $R_{\text{g}} = 4.7\Omega$  and  $T_{\text{f}} < T_{\text{fmax}}$
2. Value limited by wire bonding
3. Pulse width limited by safe operating area
4. Starting  $T_{\text{j}} = 25^{\circ}\text{C}$ ,  $I_{\text{d}} = 30\text{A}$ ,  $V_{\text{dd}} = 15\text{V}$

**Table 2. Thermal data**

$R_{\text{thj-case}}$	Thermal resistance junction-case max	1.58	$^{\circ}\text{C}/\text{W}$
$R_{\text{thj-amb}}$	Thermal resistance junction-to ambient max	100	$^{\circ}\text{C}/\text{W}$
$T_{\text{j}}$	Maximum lead temperature for soldering purpose	275	$^{\circ}\text{C}$

## 2 Electrical characteristics

( $T_{CASE}=25^{\circ}C$  unless otherwise specified)

**Table 3. On/off states**

Symbol	Parameter	Test conditions	Min.	Typ.	Max.	Unit
$V_{(BR)DSS}$	Drain-source breakdown voltage	$I_D = 25mA, V_{GS} = 0$	24			V
$I_{DSS}$	Zero gate voltage drain current ( $V_{GS} = 0$ )	$V_{DS} = 20V$ $V_{DS} = 20V, T_C = 125^{\circ}C$			1 10	$\mu A$ $\mu A$
$I_{GSS}$	Gate-body leakage current ( $V_{DS} = 0$ )	$V_{GS} = \pm 20V$			$\pm 100$	nA
$V_{GS(th)}$	Gate threshold voltage	$V_{DS} = V_{GS}, I_D = 250\mu A$	1	1.8	2.5	V
$R_{DS(on)}$	Static drain-source on resistance	$V_{GS} = 10V, I_D = 30A$ $V_{GS} = 5V, I_D = 15A$		0.0052 0.007	0.006 0.011	$\Omega$ $\Omega$

**Table 4. Dynamic**

Symbol	Parameter	Test conditions	Min.	Typ.	Max.	Unit
$g_{fs}^{(1)}$	Forward transconductance	$V_{DS} = 10V, I_D = 30A$		40		S
$C_{iss}$ $C_{oss}$ $C_{rss}$	Input capacitance Output capacitance Reverse transfer capacitance	$V_{DS} = 15V, f = 1MHz,$ $V_{GS} = 0$		2850 800 120		pF pF pF
$t_{d(on)}$ $t_r$ $t_{d(off)}$ $t_f$	Turn-on delay time Rise time Turn-off delay time Fall time	$V_{DD} = 10V, I_D = 30A$ $R_G = 4.7\Omega, V_{GS} = 10V$ (see <a href="#">Figure 13</a> )		13 75 50 18	24.3	ns ns ns ns
$Q_g$ $Q_{gs}$ $Q_{gd}$	Total gate charge Gate-source charge Gate-drain charge	$V_{DD} = 10V, I_D = 60A,$ $V_{GS} = 10V, R_G = 4.7\Omega$ (see <a href="#">Figure 14</a> )		47.5 10 7	64	nC nC nC
$Q_{oss}^{(2)}$	Output charge	$V_{DS} = 16V, V_{GS} = 0V$		18.8		nC
$Q_{gls}^{(3)}$	Third-quadrant gate charge	$V_{DS} < 0V, V_{GS} = 10V$		44		nC
$R_G$	Gate input resistance	f=1MHz Gate DC Bias =0 Test Signal Level =20mV Open Drain		1		$\Omega$

1. Pulsed: Pulse duration = 300  $\mu s$ , duty cycle 1.5 %.

2.  $Q_{oss} = C_{oss} * \Delta V_{in}$ ,  $C_{oss} = C_{gd} + C_{gd}$ . See [Chapter 4: Appendix A](#)

3. Gate charge for synchronous operation

**Table 5. Source drain diode**

Symbol	Parameter	Test conditions	Min.	Typ.	Max.	Unit
$I_{SD}$	Source-drain current				60	A
$I_{SDM}^{(1)}$	Source-drain current (pulsed)				240	A
$V_{SD}^{(2)}$	Forward on voltage	$I_{SD} = 30A, V_{GS} = 0$			1.3	V
$t_{rr}$	Reverse recovery time	$I_{SD} = 60A, di/dt = 100A/\mu s,$		35	47	ns
$Q_{rr}$	Reverse recovery charge	$V_{DD} = 16V, T_j = 150^\circ C$		35	47	nC
$I_{RRM}$	Reverse recovery current	(see <a href="#">Figure 15</a> )		2		A

1. Pulse width limited by safe operating area.
2. Pulsed: Pulse duration = 300  $\mu s$ , duty cycle 1.5 %

## 2.1 Electrical characteristics (curves)

Figure 1. Safe operating area

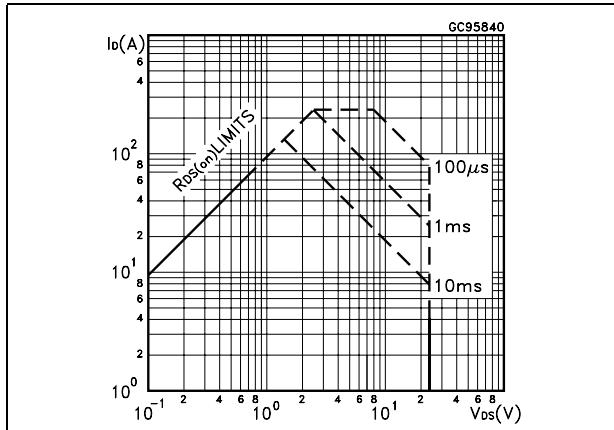

Figure 2. Thermal impedance

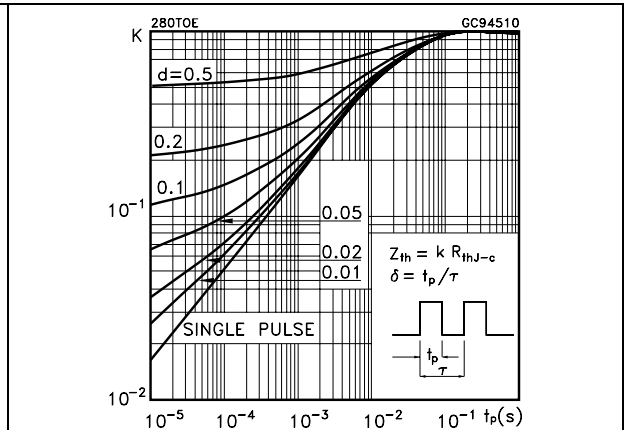

Figure 3. Output characteristics

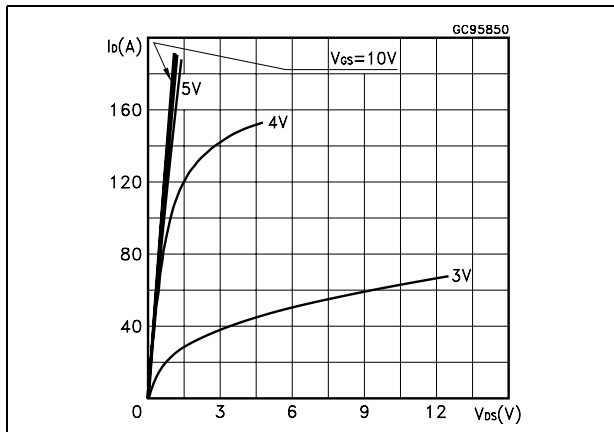

Figure 4. Transfer characteristics

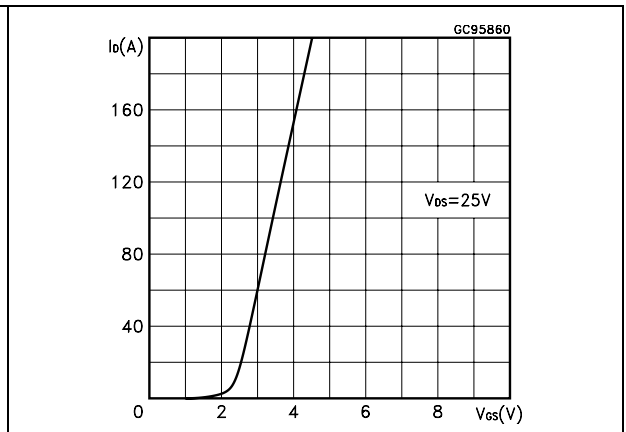

Figure 5. Transconductance

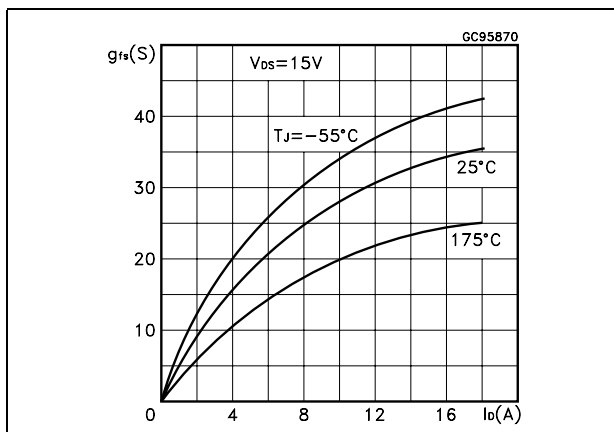

Figure 6. Static drain-source on resistance

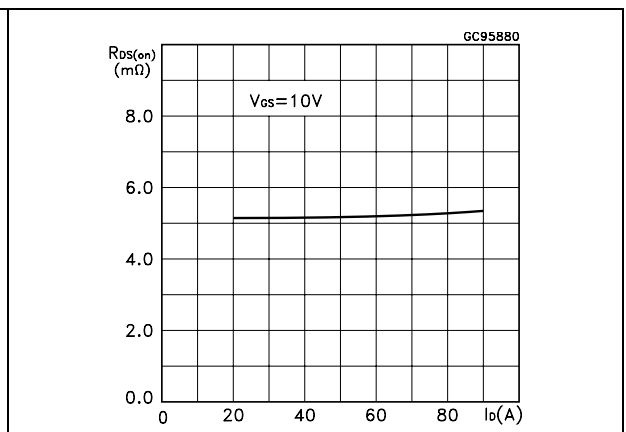

Figure 7. Gate charge vs gate-source voltage Figure 8. Capacitance variations

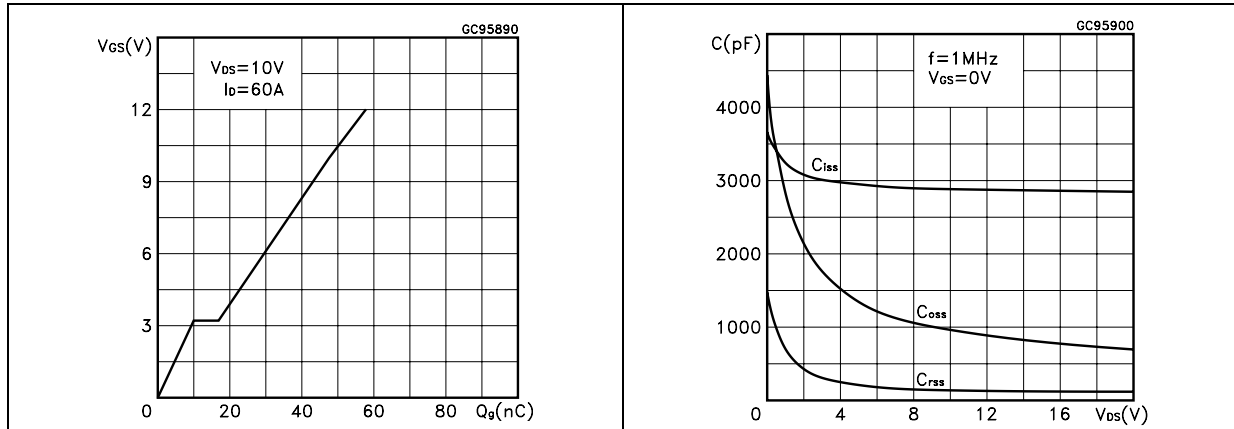

Figure 9. Normalized gate threshold voltage vs temperature Figure 10. Normalized on resistance vs temperature

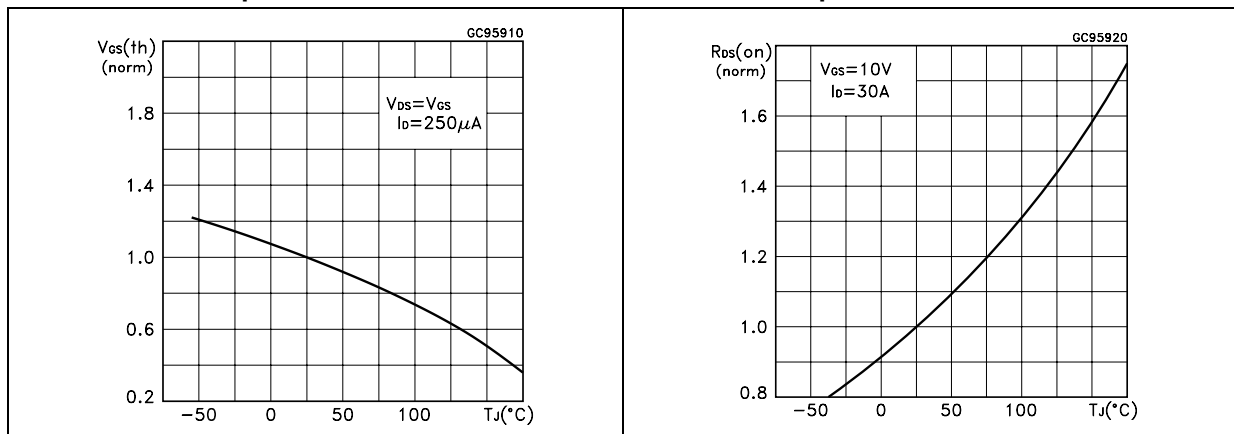
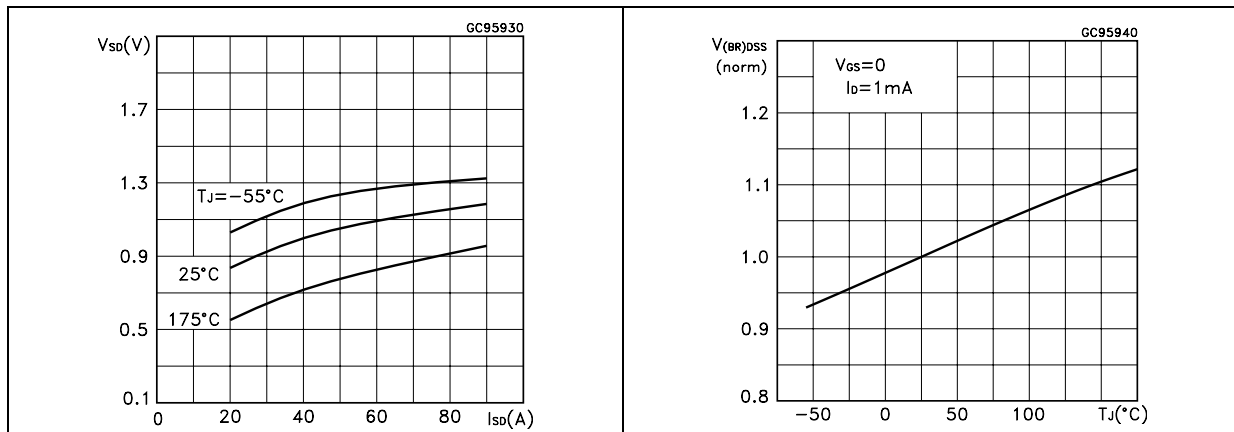

Figure 11. Source-drain diode forward characteristics Figure 12. Normalized  $BV_{DSS}$  vs temperature



### 3 Test circuit

Figure 13. Switching times test circuit for resistive load



Figure 14. Gate charge test circuit



Figure 15. Test circuit for inductive load switching and diode recovery times



Figure 16. Unclamped Inductive load test circuit



Figure 17. Unclamped inductive waveform



Figure 18. Switching time waveform





# 4 Appendix A

**Figure 19. Buck converter: power losses estimation**

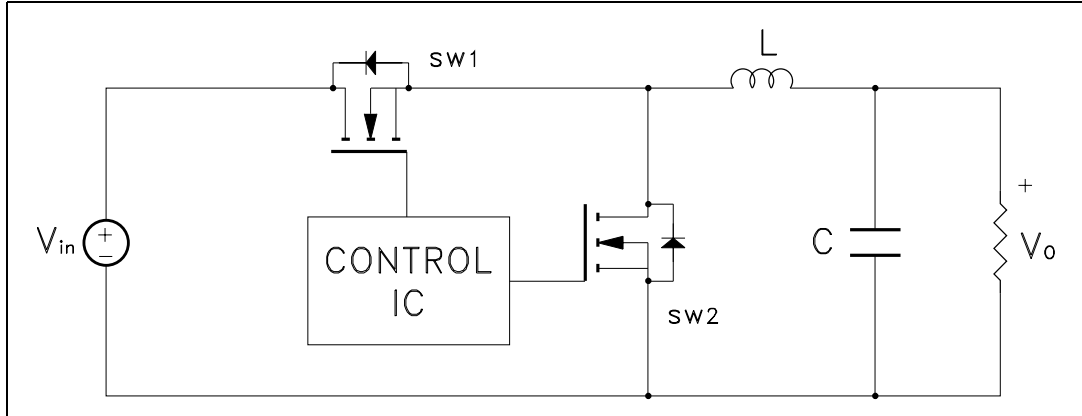

The power losses associated with the FETs in a synchronous buck converter can be estimated using the equations shown in the table below. The formulas give a good approximation, for the sake of performance comparison, of how different pairs of devices affect the converter efficiency. However a very important parameter, the working temperature, is not considered. The real device behavior is really dependent on how the heat generated inside the devices is removed to allow for a safer working junction temperature.

- The low side (SW2) device requires:
- Very low  $R_{DS(on)}$  to reduce conduction losses
- Small  $Q_{gl}$  to reduce the gate charge losses
- Small  $C_{oss}$  to reduce losses due to output capacitance
- Small  $Q_{rr}$  to reduce losses on SW1 during its turn-on
- The  $C_{gd}/C_{gs}$  ratio lower than  $V_{th}/V_{gg}$  ratio especially with low drain to source voltage to avoid the cross conduction phenomenon;
- The high side (SW1) device requires:
- Small  $R_g$  and  $L_s$  to allow higher gate current peak and to limit the voltage feedback on the gate
- Small  $Q_g$  to have a faster commutation and to reduce gate charge losses
- Low  $R_{DS(on)}$  to reduce the conduction losses.

**Table 6. Power losses calculation**

	High side switching (SW1)	Low side switch (SW2)
Pconduction	$R_{DS(on)SW1} * I_L^2 * \delta$	$R_{DS(on)SW2} * I_L^2 * (1 - \delta)$
Pswitching	$V_{in} * (Q_{gsth(SW1)} + Q_{gd(SW1)}) * f * \frac{I_L}{I_g}$	Zero Voltage Switching

**Table 6. Power losses calculation**

		High side switching (SW1)	Low side switch (SW2)
P <sub>diode</sub>	Recovery <sup>(1)</sup>	Not applicable	$V_{in} * Q_{rr(SW2)} * f$
	Conduction	Not applicable	$V_{f(SW2)} * I_L * t_{deadtime} * f$
P <sub>gate(Q<sub>G</sub>)</sub>		$Q_{g(SW1)} * V_{gg} * f$	$Q_{gls(SW2)} * V_{gg} * f$
P <sub>Qoss</sub>		$\frac{V_{in} * Q_{oss(SW1)} * f}{2}$	$\frac{V_{in} * Q_{oss(SW2)} * f}{2}$

1. Dissipated by SW1 during turn-on

**Table 7. Parameters meaning**

Parameter	Meaning
d	Duty-cycle
Q <sub>gsth</sub>	Post threshold gate charge
Q <sub>gls</sub>	Third quadrant gate charge
P <sub>conduction</sub>	On state losses
P <sub>switching</sub>	On-off transition losses
P <sub>diode</sub>	Conduction and reverse recovery diode losses
P <sub>gate</sub>	Gate drive losses
P <sub>Qoss</sub>	Output capacitance losses

## 5 Package mechanical data

In order to meet environmental requirements, ST offers these devices in ECOPACK® packages. These packages have a Lead-free second level interconnect . The category of second level interconnect is marked on the package and on the inner box label, in compliance with JEDEC Standard JESD97. The maximum ratings related to soldering conditions are also marked on the inner box label. ECOPACK is an ST trademark. ECOPACK specifications are available at: [www.st.com](http://www.st.com)

**DPAK MECHANICAL DATA**

DIM.	mm.			inch		
	MIN.	TYP.	MAX.	MIN.	TYP.	MAX.
A	2.2		2.4	0.086		0.094
A1	0.9		1.1	0.035		0.043
A2	0.03		0.23	0.001		0.009
B	0.64		0.9	0.025		0.035
b4	5.2		5.4	0.204		0.212
C	0.45		0.6	0.017		0.023
C2	0.48		0.6	0.019		0.023
D	6		6.2	0.236		0.244
D1		5.1			0.200	
E	6.4		6.6	0.252		0.260
E1		4.7			0.185	
e		2.28			0.090	
e1	4.4		4.6	0.173		0.181
H	9.35		10.1	0.368		0.397
L	1			0.039		
(L1)		2.8			0.110	
L2		0.8			0.031	
L4	0.6		1	0.023		0.039
R		0.2			0.008	
V2	0°		8°	0°		8°

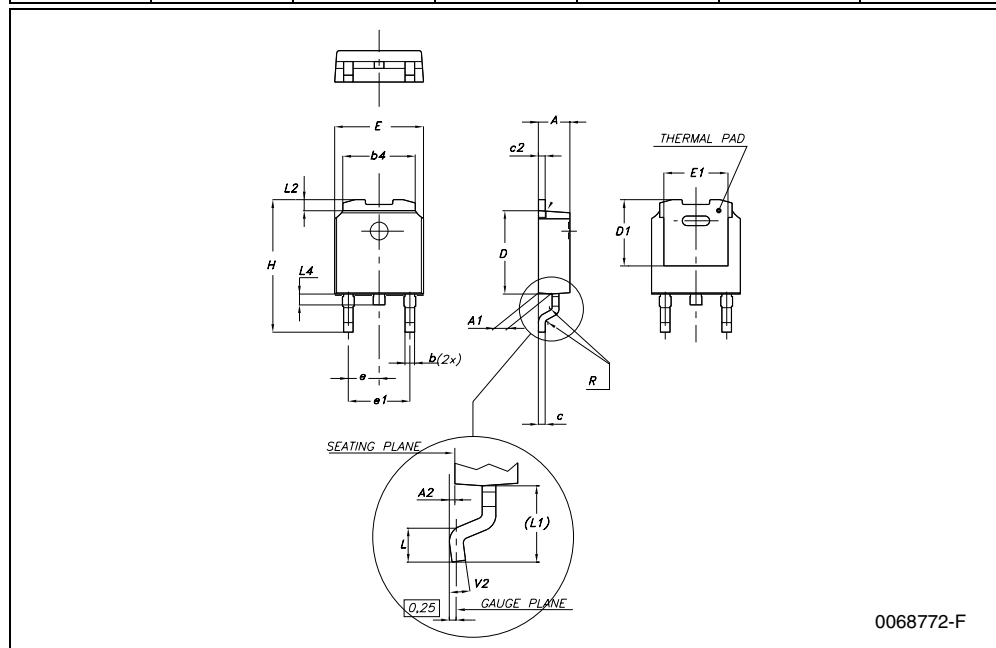

**TO-251 (IPAK) MECHANICAL DATA**

DIM.	mm			inch		
	MIN.	TYP.	MAX.	MIN.	TYP.	MAX.
A	2.2		2.4	0.086		0.094
A1	0.9		1.1	0.035		0.043
A3	0.7		1.3	0.027		0.051
B	0.64		0.9	0.025		0.031
B2	5.2		5.4	0.204		0.212
B3			0.85			0.033
B5		0.3			0.012	
B6			0.95			0.037
C	0.45		0.6	0.017		0.023
C2	0.48		0.6	0.019		0.023
D	6		6.2	0.236		0.244
E	6.4		6.6	0.252		0.260
G	4.4		4.6	0.173		0.181
H	15.9		16.3	0.626		0.641
L	9		9.4	0.354		0.370
L1	0.8		1.2	0.031		0.047
L2		0.8	1		0.031	0.039

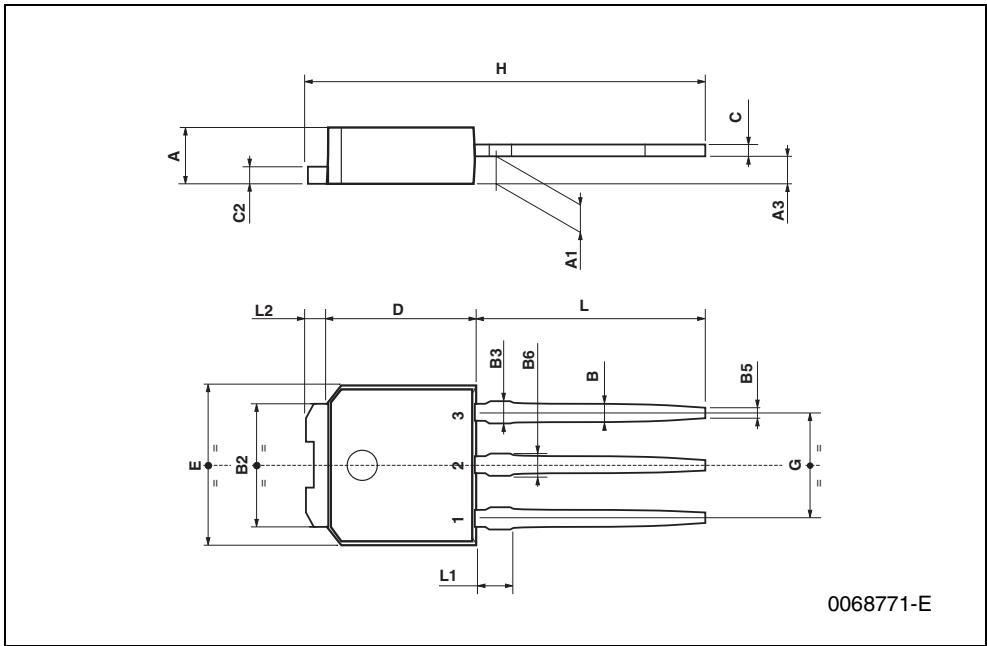

# 6 Packing mechanical data

## DPAK FOOTPRINT

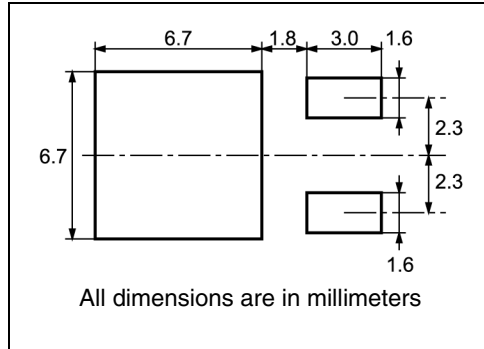

## TAPE AND REEL SHIPMENT

40 mm min. Access hole at slot location

Full radius

Tape slot in core for tape start 2.5mm min. width

G measured at hub

### REEL MECHANICAL DATA

DIM.	mm		inch	
	MIN.	MAX.	MIN.	MAX.
A		330		12.992
B	1.5		0.059	
C	12.8	13.2	0.504	0.520
D	20.2		0.795	
G	16.4	18.4	0.645	0.724
N	50		1.968	
T		22.4		0.881

### TAPE MECHANICAL DATA

DIM.	mm		inch	
	MIN.	MAX.	MIN.	MAX.
A0	6.8	7	0.267	0.275
B0	10.4	10.6	0.409	0.417
B1		12.1		0.476
D	1.5	1.6	0.059	0.063
D1	1.5		0.059	
E	1.65	1.85	0.065	0.073
F	7.4	7.6	0.291	0.299
K0	2.55	2.75	0.100	0.108
P0	3.9	4.1	0.153	0.161
P1	7.9	8.1	0.311	0.319
P2	1.9	2.1	0.075	0.082
R	40		1.574	
W	15.7	16.3	0.618	0.641

TOP COVER TAPE

User Direction of Feed

Center line of cavity

Bending radius R min.

FEED DIRECTION

TRL

For machine ref. only including draft and radii concentric around B0

10 pitches cumulative tolerance on tape +/- 0.2 mm

## 7 Revision history

**Table 8. Revision history**

<b>Date</b>	<b>Revision</b>	<b>Changes</b>
097-Sep-2004	5	Complete document
03-Aug-2006	6	New template, no content change

**Please Read Carefully:**

Information in this document is provided solely in connection with ST products. STMicroelectronics NV and its subsidiaries ("ST") reserve the right to make changes, corrections, modifications or improvements, to this document, and the products and services described herein at any time, without notice.

All ST products are sold pursuant to ST's terms and conditions of sale.

Purchasers are solely responsible for the choice, selection and use of the ST products and services described herein, and ST assumes no liability whatsoever relating to the choice, selection or use of the ST products and services described herein.

No license, express or implied, by estoppel or otherwise, to any intellectual property rights is granted under this document. If any part of this document refers to any third party products or services it shall not be deemed a license grant by ST for the use of such third party products or services, or any intellectual property contained therein or considered as a warranty covering the use in any manner whatsoever of such third party products or services or any intellectual property contained therein.

**UNLESS OTHERWISE SET FORTH IN ST'S TERMS AND CONDITIONS OF SALE ST DISCLAIMS ANY EXPRESS OR IMPLIED WARRANTY WITH RESPECT TO THE USE AND/OR SALE OF ST PRODUCTS INCLUDING WITHOUT LIMITATION IMPLIED WARRANTIES OF MERCHANTABILITY, FITNESS FOR A PARTICULAR PURPOSE (AND THEIR EQUIVALENTS UNDER THE LAWS OF ANY JURISDICTION), OR INFRINGEMENT OF ANY PATENT, COPYRIGHT OR OTHER INTELLECTUAL PROPERTY RIGHT.**

**UNLESS EXPRESSLY APPROVED IN WRITING BY AN AUTHORIZED ST REPRESENTATIVE, ST PRODUCTS ARE NOT RECOMMENDED, AUTHORIZED OR WARRANTED FOR USE IN MILITARY, AIR CRAFT, SPACE, LIFE SAVING, OR LIFE SUSTAINING APPLICATIONS, NOR IN PRODUCTS OR SYSTEMS WHERE FAILURE OR MALFUNCTION MAY RESULT IN PERSONAL INJURY, DEATH, OR SEVERE PROPERTY OR ENVIRONMENTAL DAMAGE. ST PRODUCTS WHICH ARE NOT SPECIFIED AS "AUTOMOTIVE GRADE" MAY ONLY BE USED IN AUTOMOTIVE APPLICATIONS AT USER'S OWN RISK.**

Resale of ST products with provisions different from the statements and/or technical features set forth in this document shall immediately void any warranty granted by ST for the ST product or service described herein and shall not create or extend in any manner whatsoever, any liability of ST.

ST and the ST logo are trademarks or registered trademarks of ST in various countries.

Information in this document supersedes and replaces all information previously supplied.

The ST logo is a registered trademark of STMicroelectronics. All other names are the property of their respective owners.

© 2006 STMicroelectronics - All rights reserved

STMicroelectronics group of companies

Australia - Belgium - Brazil - Canada - China - Czech Republic - Finland - France - Germany - Hong Kong - India - Israel - Italy - Japan - Malaysia - Malta - Morocco - Singapore - Spain - Sweden - Switzerland - United Kingdom - United States of America

[www.st.com](http://www.st.com)