

Features

- Epitaxial Planar Die Construction
- Complementary PNP Type Available (DMMT5401)
- Ideal for Low Power Amplification and Switching
- Intrinsically Matched NPN Pair (Note 1)
- 2% Matched Tolerance, h_{FE} , $V_{CE(SAT)}$, $V_{BE(SAT)}$
- **Lead Free/RoHS Compliant (Note 4)**
- **"Green" Device (Note 5 and 6)**

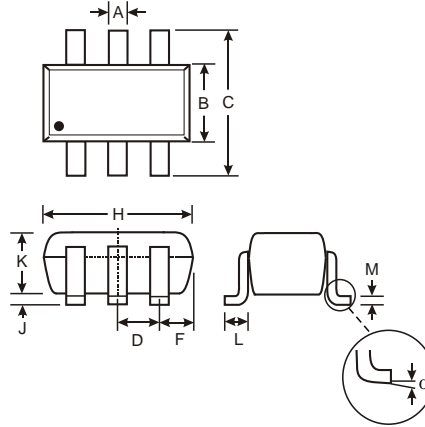

| SOT-26 | | | |
|----------------------|-------|------|------|
| Dim | Min | Max | Typ |
| A | 0.35 | 0.50 | 0.38 |
| B | 1.50 | 1.70 | 1.60 |
| C | 2.70 | 3.00 | 2.80 |
| D | | | 0.95 |
| F | | | 0.55 |
| H | 2.90 | 3.10 | 3.00 |
| J | 0.013 | 0.10 | 0.05 |
| K | 1.00 | 1.30 | 1.10 |
| L | 0.35 | 0.55 | 0.40 |
| M | 0.10 | 0.20 | 0.15 |
| | 0° | 8° | |
| All Dimensions in mm | | | |

Mechanical Data

- Case: SOT-26
- Case Material: Molded Plastic, "Green" Molding Compound, Note 7. UL Flammability Classification Rating 94V-0
- Moisture Sensitivity: Level 1 per J-STD-020C
- Terminal Connections: See Diagram
- Terminals: Solderable per MIL-STD-202, Method 208
- Lead Free Plating (Matte Tin Finish annealed over Copper leadframe).
- Marking (See Page 2): K4R & K4T
- Ordering & Date Code Information: See Page 2
- Weight: 0.006 grams (approximate)

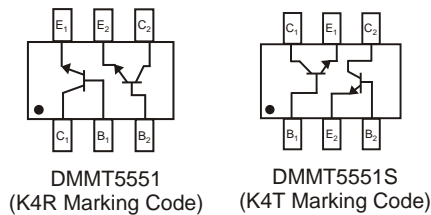

Maximum Ratings @ $T_A = 25^\circ\text{C}$ unless otherwise specified

| Characteristic | Symbol | Value | Unit |
|--|----------------|-------------|---------------------------|
| Collector-Base Voltage | V_{CBO} | 180 | V |
| Collector-Emitter Voltage | V_{CEO} | 160 | V |
| Emitter-Base Voltage | V_{EBO} | 6.0 | V |
| Collector Current - Continuous (Note 2) | I_C | 200 | mA |
| Power Dissipation (Note 2, 3) | P_d | 300 | mW |
| Thermal Resistance, Junction to Ambient (Note 2) | R_{JA} | 417 | $^\circ\text{C}/\text{W}$ |
| Operating and Storage and Temperature Range | T_j, T_{STG} | -55 to +150 | $^\circ\text{C}$ |

- Notes:
1. Built with adjacent die from a single wafer.
 2. Device mounted on FR-4 PCB, 1 inch x 0.85 inch x 0.062 inch; pad layout as shown on Diodes Inc. suggested pad layout document AP02001, which can be found on our website at <http://www.diodes.com/datasheets/ap02001.pdf>.
 3. Maximum combined dissipation.
 4. No purposefully added lead.
 5. Diodes Inc.'s "Green" policy can be found on our website at http://www.diodes.com/products/lead_free/index.php.
 6. Product manufactured with Date Code 0627 (week 27, 2006) and newer are built with Green Molding Compound. Product manufactured prior to Date Code 0627 are built with Non-Green Molding Compound and may contain Halogens or Sb2O3 Fire Retardants.

Electrical Characteristics @ $T_A = 25^\circ\text{C}$ unless otherwise specified

| Characteristic | Symbol | Min | Max | Unit | Test Condition |
|--------------------------------------|---------------|----------------|--------------|---------------------|--|
| OFF CHARACTERISTICS (Note 7) | | | | | |
| Collector-Base Breakdown Voltage | $V_{(BR)CBO}$ | 180 | | V | $I_C = 100\mu\text{A}, I_E = 0$ |
| Collector-Emitter Breakdown Voltage | $V_{(BR)CEO}$ | 160 | | V | $I_C = 1.0\text{mA}, I_B = 0$ |
| Emitter-Base Breakdown Voltage | $V_{(BR)EBO}$ | 6.0 | | V | $I_E = 10\mu\text{A}, I_C = 0$ |
| Collector Cutoff Current | I_{CBO} | | 50 | nA μA | $V_{CB} = 120\text{V}, I_E = 0$ $V_{CB} = 120\text{V}, I_E = 0, T_A = 100^\circ\text{C}$ |
| Emitter Cutoff Current | I_{EBO} | | 50 | nA | $V_{EB} = 4.0\text{V}, I_C = 0$ |
| ON CHARACTERISTICS (Note 7) | | | | | |
| DC Current Gain (Note 8) | h_{FE} | 80 80 30 | 250 | | $I_C = 1.0\text{mA}, V_{CE} = 5.0\text{V}$ $I_C = 10\text{mA}, V_{CE} = 5.0\text{V}$ $I_C = 50\text{mA}, V_{CE} = 5.0\text{V}$ |
| Collector-Emitter Saturation Voltage | $V_{CE(SAT)}$ | | 0.15 0.20 | V | $I_C = 10\text{mA}, I_B = 1.0\text{mA}$ $I_C = 50\text{mA}, I_B = 5.0\text{mA}$ |
| Base-Emitter Saturation Voltage | $V_{BE(SAT)}$ | | 1.0 | V | $I_C = 10\text{mA}, I_B = 1.0\text{mA}$ $I_C = 50\text{mA}, I_B = 5.0\text{mA}$ |
| SMALL SIGNAL CHARACTERISTICS | | | | | |
| Output Capacitance | C_{obo} | | 6.0 | pF | $V_{CB} = 10\text{V}, f = 1.0\text{MHz}, I_E = 0$ |
| Small Signal Current Gain | h_{FE} | 50 | 250 | | $V_{CE} = 10\text{V}, I_C = 1.0\text{mA}, f = 1.0\text{kHz}$ |
| Current Gain-Bandwidth Product | f_T | 100 | 300 | MHz | $V_{CE} = 10\text{V}, I_C = 10\text{mA}, f = 100\text{MHz}$ |
| Noise Figure | NF | | 8.0 | dB | $V_{CE} = 5.0\text{V}, I_C = 200\mu\text{A}, R_S = 1.0\text{k}\Omega, f = 1.0\text{kHz}$ |

Ordering Information (Note 6 & 9)

| Device | Packaging | Shipping |
|---------------|-----------|------------------|
| DMMT5551-7-F | SOT-26 | 3000/Tape & Reel |
| DMMT5551S-7-F | SOT-26 | 3000/Tape & Reel |

- Notes:
- Product manufactured with Date Code 0627 (week 27, 2006) and newer are built with Green Molding Compound. Product manufactured prior to Date Code 0627 are built with Non-Green Molding Compound and may contain Halogens or Sb2O3 Fire Retardants.
 - Short duration pulse test used to minimize self-heating effect.
 - The DC Current Gain, h_{FE} , (matched at $I_C = 10\text{mA}$ and $V_{CE} = 5\text{V}$) Collector Emitter Saturation Voltage, $V_{CE(SAT)}$, and Base Emitter Saturation Voltage, $V_{BE(SAT)}$ are matched with typical matched tolerances of 1% and maximum of 2%.
 - For Packaging Details, go to our website at <http://www.diodes.com/datasheets/ap02007.pdf>.

Marking Information

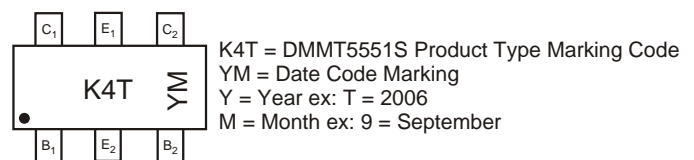
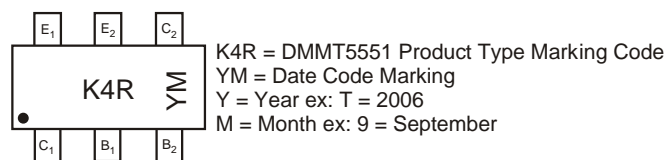

Date Code Key

| Year | 2003 | 2004 | 2005 | 2006 | 2007 | 2008 | 2009 | 2010 | 2011 | 2012 |
|------|------|------|------|------|------|------|------|------|------|------|
| Code | Q | R | S | T | U | V | W | X | Y | Z |

| Month | Jan | Feb | Mar | Apr | May | Jun | Jul | Aug | Sep | Oct | Nov | Dec |
|-------|-----|-----|-----|-----|-----|-----|-----|-----|-----|-----|-----|-----|
| Code | 1 | 2 | 3 | 4 | 5 | 6 | 7 | 8 | 9 | O | N | D |

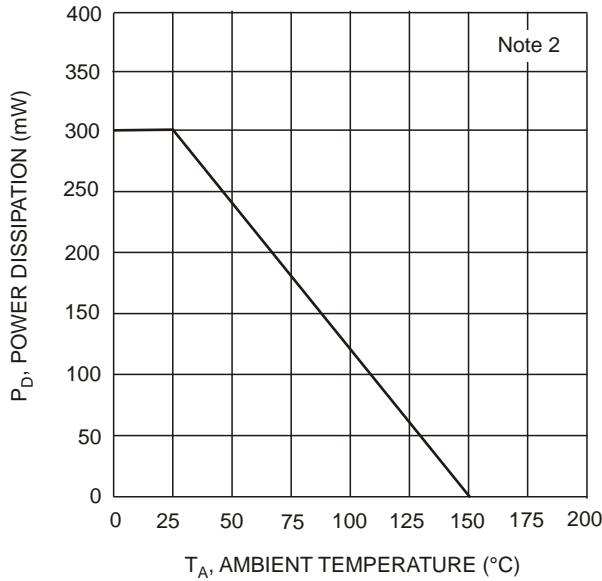

T_A , AMBIENT TEMPERATURE (°C)
Fig. 1, Max Power Dissipation vs Ambient Temperature

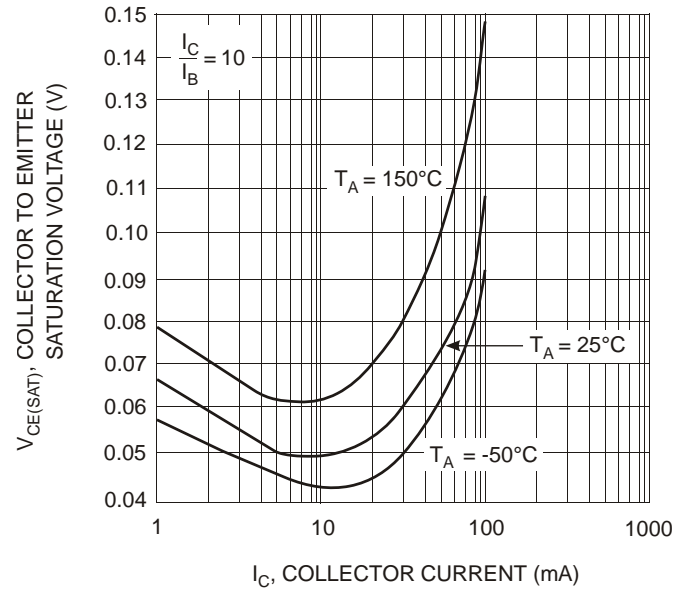

I_C , COLLECTOR CURRENT (mA)
Fig. 2, Collector Emitter Saturation Voltage vs. Collector Current

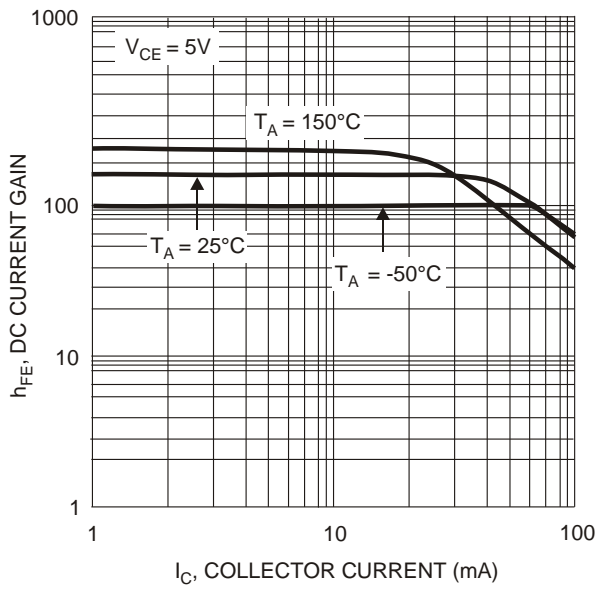

I_C , COLLECTOR CURRENT (mA)
Fig. 3, DC Current Gain vs Collector Current

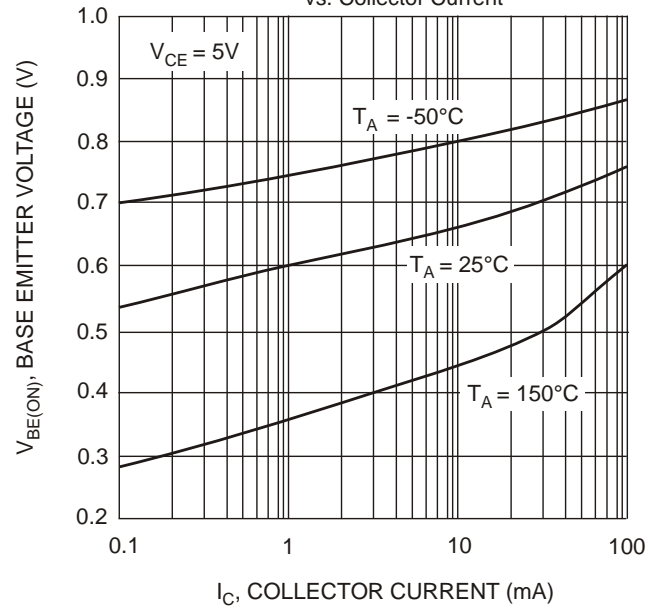

I_C , COLLECTOR CURRENT (mA)
Fig. 4, Base Emitter Voltage vs. Collector Current

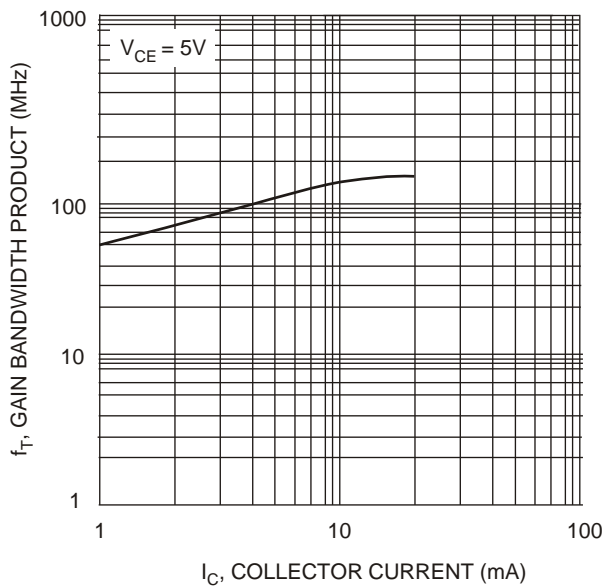

I_C , COLLECTOR CURRENT (mA)
Fig. 5, Gain Bandwidth Product vs. Collector Current

IMPORTANT NOTICE

Diodes Incorporated and its subsidiaries reserve the right to make modifications, enhancements, improvements, corrections or other changes without further notice to any product herein. Diodes Incorporated does not assume any liability arising out of the application or use of any product described herein; neither does it convey any license under its patent rights, nor the rights of others. The user of products in such applications shall assume all risks of such use and will agree to hold Diodes Incorporated and all the companies whose products are represented on our website, harmless against all damages.

LIFE SUPPORT

Diodes Incorporated products are not authorized for use as critical components in life support devices or systems without the expressed written approval of the President of Diodes Incorporated.