

STEERING DIODE/TVS ARRAY COMBO

APPLICATIONS

- ✓ Ethernet - 10/100 Base T
- ✓ FireWire
- ✓ Wireless Communications
- ✓ USB Interface

IEC COMPATIBILITY (EN61000-4)

- ✓ 61000-4-2 (ESD): Air - 15kV, Contact - 8kV
- ✓ 61000-4-4 (EFT): 40A - 5/50ns
- ✓ 61000-4-5 (Surge): 24A, 8/20 μ s - Level 2(Line-Gnd) & Level 3(Line-Line)

FEATURES

- ✓ 200 Watts Peak Power per Line (tp = 8/20 μ s)
- ✓ ESD Protection > 25 kilovolts
- ✓ Low Clamping Voltage
- ✓ Unidirectional Configuration
- ✓ Protects 2 I/O Ports & Power Supply
- ✓ Ultra-Low Capacitance: 0.6pF
- ✓ RoHS Compliant

MECHANICAL CHARACTERISTICS

- ✓ Molded JEDEC SOT-543
- ✓ Weight 3 milligrams (Approximate)
- ✓ Available in Lead-Free Pure-Tin Plating(Annealed)
- ✓ Solder Reflow Temperature:
Pure-Tin - Sn, 100: 260-270°C
- ✓ Consult Factory for Leaded Device Availability
- ✓ Flammability Rating UL 94V-0
- ✓ 8mm Tape and Reel Per EIA Standard 481
- ✓ Marking: Marking Code

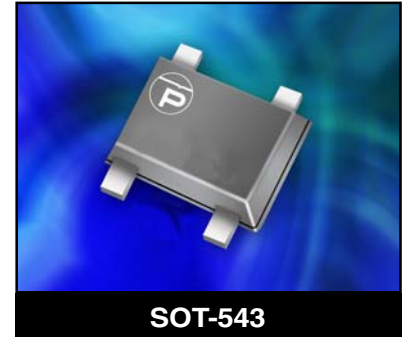

PIN CONFIGURATION

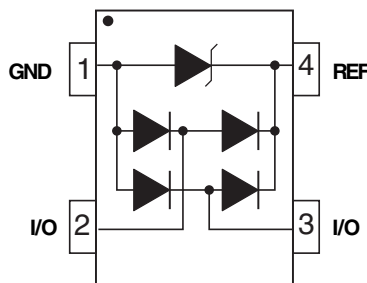

DEVICE CHARACTERISTICS

MAXIMUM RATINGS @ 25°C Unless Otherwise Specified

PARAMETER	SYMBOL	VALUE	UNITS
Peak Pulse Power (tp = 8/20μs) - See Figure 1	P _{PP}	200	Watts
Operating Temperature	T _L	-55 to 150	°C
Storage Temperature	T _{STG}	-55 to 150	°C
Peak Forward Voltage - I _F = 1A, 8/20μs	V _F	1.5	Volts

ELECTRICAL CHARACTERISTICS PER LINE @ 25°C Unless Otherwise Specified

PART NUMBER	DEVICE MARKING	RATED STAND-OFF VOLTAGE V _{WM} VOLTS	MINIMUM BREAKDOWN VOLTAGE @ 1mA V _(BR) VOLTS	MAXIMUM CLAMPING VOLTAGE (See Fig. 2) (See Note 2) @ I _F = 1A V _C VOLTS	MAXIMUM CLAMPING VOLTAGE (See Fig. 2) (See Note 2) 8/20μs V _C @ I _{PP} VOLTS	MAXIMUM LEAKAGE CURRENT @ V _{WM} I _b μA	MAXIMUM CAPACITANCE (See Note 1) (See Fig. 5) (Per Data Line) @ 0V, 1 MHz C _{J(SD)} pF
PLR0502	B5	5.0	6.0	9.8	20.0V @ 10.0A	1.0	0.6

Note 1: As shown in Figure 5, REF 1 is connected to ground, REF 2 is connected to +V_{CC} and input applies to V_{CC} = 5V, V_{sign} = 30mV, F = 1MHz.

Note 2: Measured across pin 1 to pin 4.

FIGURE 1
PEAK PULSE POWER VS PULSE TIME

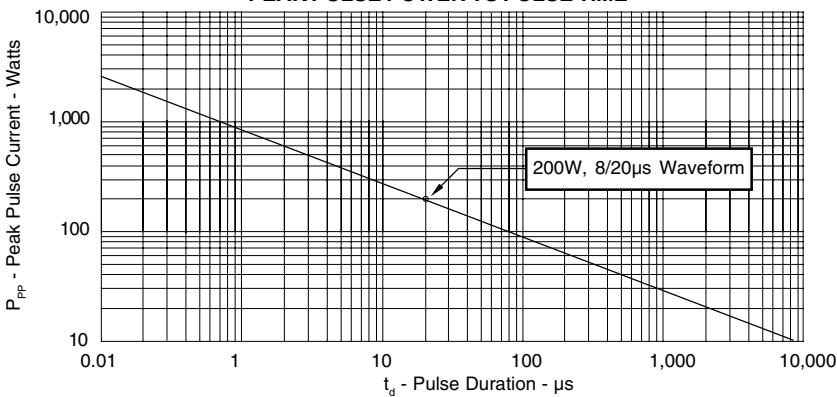
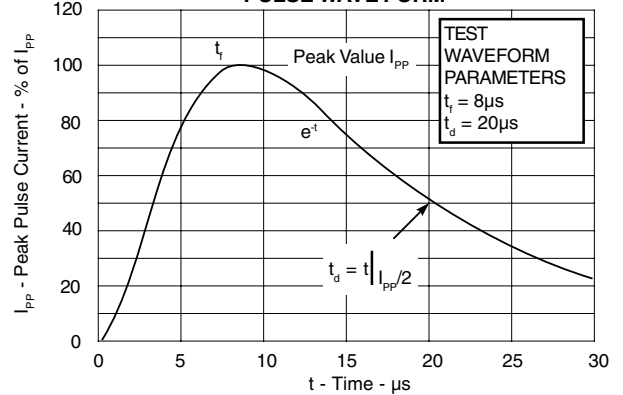
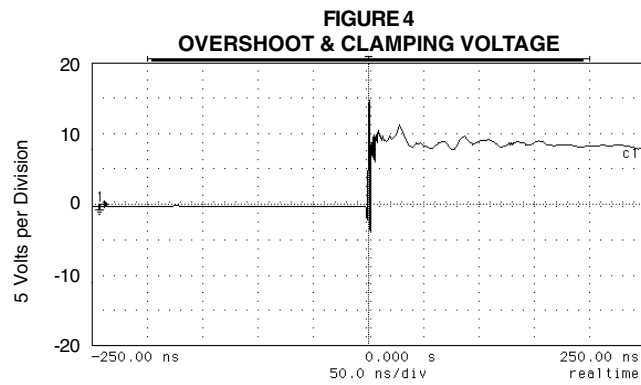
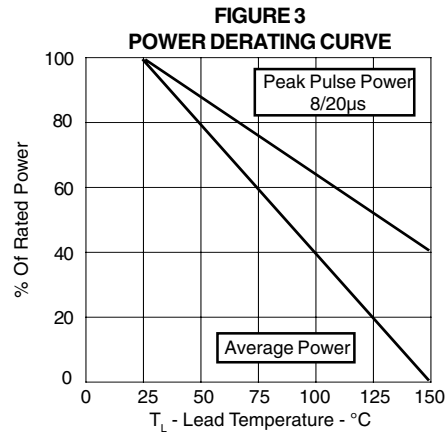

FIGURE 2
PULSE WAVE FORM



GRAPHS



ESD Test Pulse: 5 kilovolt, 1/30ns (waveform)

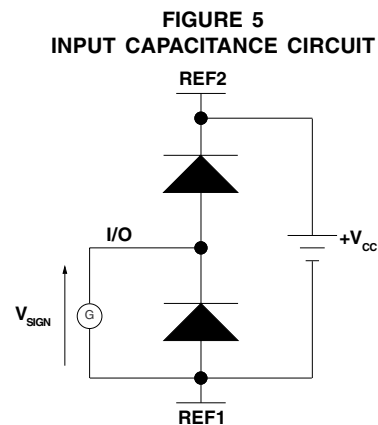

SOT-543 PACKAGE OUTLINE & DIMENSIONS

PACKAGE OUTLINE		PACKAGE DIMENSIONS			
DIM	MILLIMETERS		INCHES		
	MIN	MAX	MIN	MAX	
A	1.50	1.70	0.059	0.067	
B	1.10	1.30	0.043	0.051	
C	0.50	0.60	0.020	0.024	
D	0.17	0.27	0.007	0.011	
G	0.50 BSC	-	0.020 BSC	-	
H	1.50	1.70	0.059	0.067	
J	0.08	0.16	0.003	0.007	
K	0.10	0.30	0.004	0.0120	
R	0.05	0.15	0.002	0.006	

Do not connect center stub.

NOTES

1. Dimensioning and tolerances per ANSI Y14.5M, 1985.
2. Controlling Dimension: Inches
3. Pin 3 is the cathode (Unidirectional Only).
4. Dimensions are exclusive of mold flash and metal burrs.

MOUNTING PAD			TAPING & REEL ORDERING NOMENCLATURE																			
<table border="1" style="margin: auto;"> <thead> <tr> <th colspan="3" style="text-align: center;">TYPICAL</th> </tr> <tr> <th style="text-align: center;">DIM</th> <th style="text-align: center;">Millimeters</th> <th style="text-align: center;">Inches</th> </tr> </thead> <tr> <td style="text-align: center;">1</td> <td style="text-align: center;">0.30</td> <td style="text-align: center;">0.012</td> </tr> <tr> <td style="text-align: center;">2</td> <td style="text-align: center;">1.02</td> <td style="text-align: center;">0.040</td> </tr> <tr> <td style="text-align: center;">3</td> <td style="text-align: center;">1.40</td> <td style="text-align: center;">0.055</td> </tr> <tr> <td style="text-align: center;">4</td> <td style="text-align: center;">0.51</td> <td style="text-align: center;">0.020</td> </tr> </table>			TYPICAL			DIM	Millimeters	Inches	1	0.30	0.012	2	1.02	0.040	3	1.40	0.055	4	0.51	0.020		
TYPICAL																						
DIM	Millimeters	Inches																				
1	0.30	0.012																				
2	1.02	0.040																				
3	1.40	0.055																				
4	0.51	0.020																				
			<ol style="list-style-type: none"> 1. Surface mount product is taped and reeled in accordance with EIA-481. 2. Suffix-T7 = 7 Inch Reel - 3,000 pieces per 8mm tape, i.e., PLR0502-T7. 3. Suffix - LF = Lead-Free Plating, i.e., PLR0502-LF-T7. 																			

Outline & Dimensions: Rev 0 - 1/07, 06071

Tape & Reel Specifications (Dimensions in millimeters)

Reel Dia.	Tape Width	A0	B0	K0	D	E	F	W	P0	P2	P	tmax
178mm (7")	8mm	1.78 ± 0.05	1.78 ± 0.05	0.69 ± 0.05	1.50 ± 0.10	1.75 ± 0.10	3.50 ± 0.05	8.00 ± 0.30	4.00 ± 0.10	2.00 ± 0.05	4.00 ± 0.10	0.25

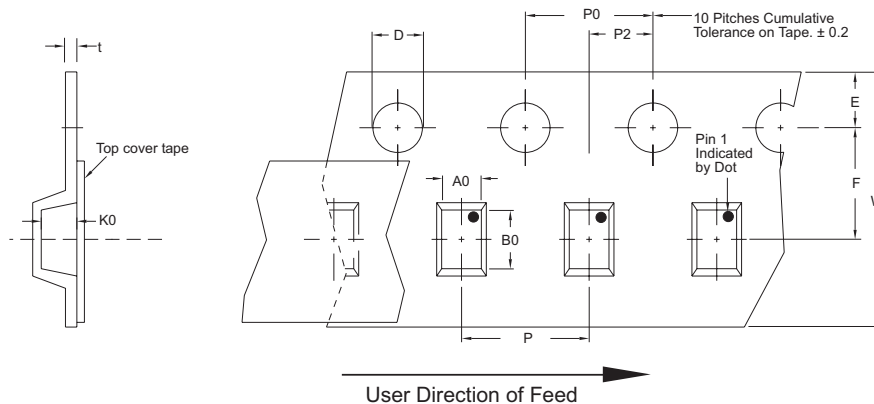

COPYRIGHT © ProTek Devices 2007

SPECIFICATIONS: ProTek reserves the right to change the electrical and or mechanical characteristics described herein without notice (except JEDEC).

DESIGN CHANGES: ProTek reserves the right to discontinue product lines without notice, and that the final judgement concerning selection and specifications is the buyer's and that in furnishing engineering and technical assistance, ProTek assumes no responsibility with respect to the selection or specifications of such products.

ProTek Devices
 2929 South Fair Lane, Tempe, AZ 85282
 Tel: 602-431-8101 Fax: 602-431-2288
 E-Mail: sales@protekdevices.com
 Web Site: www.protekdevices.com