

2SA1774

PNP Silicon General Purpose Amplifier Transistor

This PNP transistor is designed for general purpose amplifier applications. This device is housed in the SC-75/SOT-416/SC-90 package which is designed for low power surface mount applications, where board space is at a premium.

Features

- Reduces Board Space
- High h_{FE} , 210–460 (typical)
- Low $V_{CE(sat)}$, < 0.5 V
- Available in 8 mm, 7-inch/3000 Unit Tape and Reel
- Pb-Free Package is Available*

MAXIMUM RATINGS ($T_A = 25^\circ\text{C}$)

Rating	Symbol	Value	Unit
Collector – Emitter Voltage	$V_{(BR)CBO}$	–60	Vdc
Collector – Base Voltage	$V_{(BR)CEO}$	–50	Vdc
Emitter – Base Voltage	$V_{(BR)EBO}$	–6.0	Vdc
Collector Current – Continuous	I_C	–100	mAdc

Maximum ratings are those values beyond which device damage can occur. Maximum ratings applied to the device are individual stress limit values (not normal operating conditions) and are not valid simultaneously. If these limits are exceeded, device functional operation is not implied, damage may occur and reliability may be affected.

THERMAL CHARACTERISTICS

Characteristic	Symbol	Max	Unit
Power Dissipation (Note 1)	P_D	150	mW
Junction Temperature	T_J	150	$^\circ\text{C}$
Storage Temperature Range	T_{stg}	–55 ~ +150	$^\circ\text{C}$

1. Device mounted on a FR-4 glass epoxy printed circuit board using the minimum recommended footprint.



ON Semiconductor®

<http://onsemi.com>

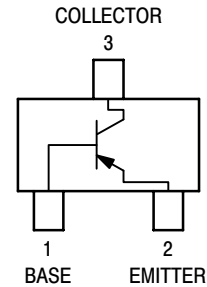

SC-75
CASE 463-01
STYLE 1

MARKING DIAGRAM

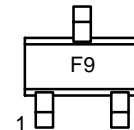

F9 = Specific Device Code

ORDERING INFORMATION

See detailed ordering and shipping information in the package dimensions section on page 2 of this data sheet.

*For additional information on our Pb-Free strategy and soldering details, please download the ON Semiconductor Soldering and Mounting Techniques Reference Manual, SOLDERRM/D.

2SA1774

ELECTRICAL CHARACTERISTICS ($T_A = 25^\circ\text{C}$)

Characteristic	Symbol	Min	Typ	Max	Unit
Collector-Base Breakdown Voltage ($I_C = -50 \mu\text{Adc}$, $I_E = 0$)	$V_{(BR)CBO}$	-60	-	-	Vdc
Collector-Emitter Breakdown Voltage ($I_C = -1.0 \text{mAdc}$, $I_B = 0$)	$V_{(BR)CEO}$	-50	-	-	Vdc
Emitter-Base Breakdown Voltage ($I_E = -50 \mu\text{Adc}$, $I_C = 0$)	$V_{(BR)EBO}$	-6.0	-	-	Vdc
Collector-Base Cutoff Current ($V_{CB} = -30 \text{Vdc}$, $I_E = 0$)	I_{CBO}	-	-	-0.5	nA
Emitter-Base Cutoff Current ($V_{EB} = -5.0 \text{Vdc}$, $I_B = 0$)	I_{EBO}	-	-	-0.5	μA
Collector-Emitter Saturation Voltage (Note 2) ($I_C = -50 \text{mAdc}$, $I_B = -5.0 \text{mAdc}$)	$V_{CE(sat)}$	-	-	-0.5	Vdc
DC Current Gain (Note 2) ($V_{CE} = -6.0 \text{Vdc}$, $I_C = -1.0 \text{mAdc}$)	h_{FE}	120	-	560	-
Transition Frequency ($V_{CE} = -12 \text{Vdc}$, $I_C = -2.0 \text{mAdc}$, $f = 30 \text{MHz}$)	f_T	-	140	-	MHz
Output Capacitance ($V_{CB} = -12 \text{Vdc}$, $I_E = 0 \text{Adc}$, $f = 1 \text{MHz}$)	C_{OB}	-	3.5	-	pF

2. Pulse Test: Pulse Width $\leq 300 \mu\text{s}$, D.C. $\leq 2\%$.

ORDERING INFORMATION

Device	Package	Shipping [†]
2SA1774	SC-75	3000 Tape & Reel
2SA1774G	SC-75 (Pb-Free)	3000 Tape & Reel
2SA1774T1	SC-75	3000 Tape & Reel

[†]For information on tape and reel specifications, including part orientation and tape sizes, please refer to our Tape and Reel Packaging Specifications Brochure, BRD8011/D.

TYPICAL ELECTRICAL CHARACTERISTICS

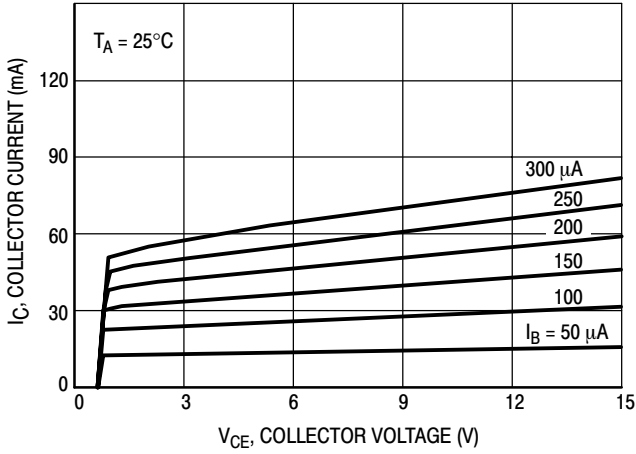

Figure 1. $I_C - V_{CE}$

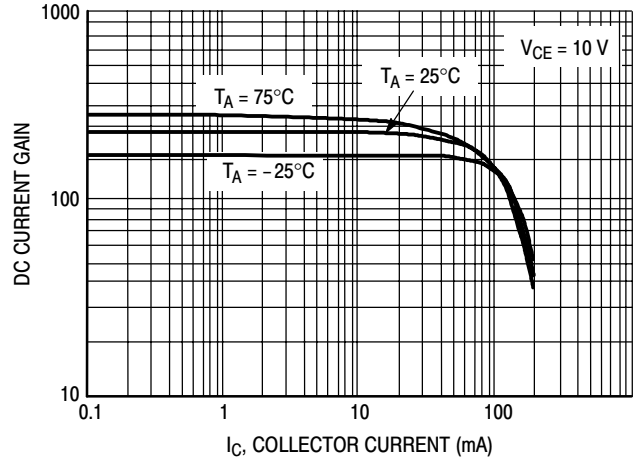

Figure 2. DC Current Gain

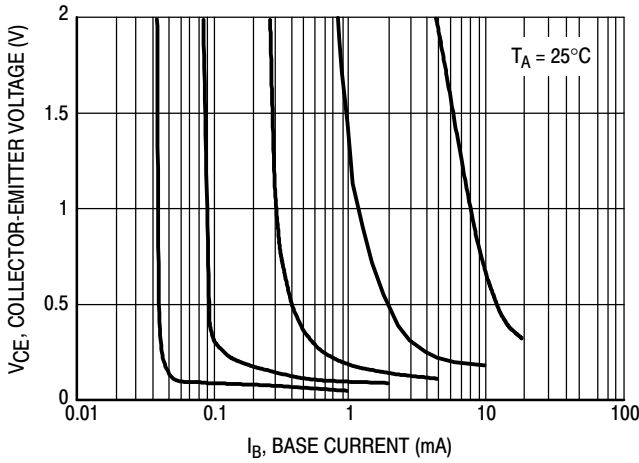

Figure 3. Collector Saturation Region

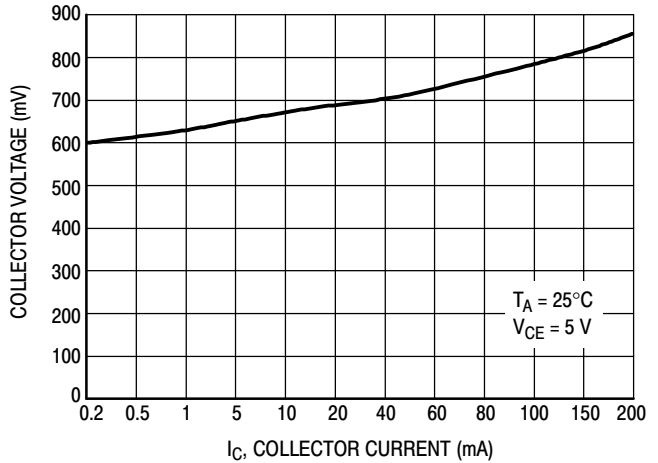

Figure 4. On Voltage

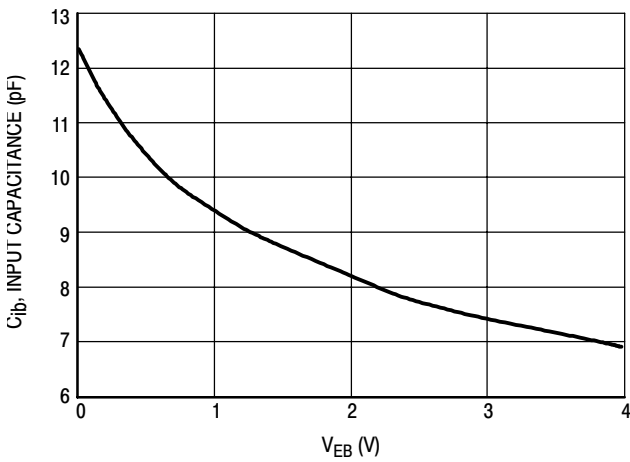

Figure 5. Capacitance

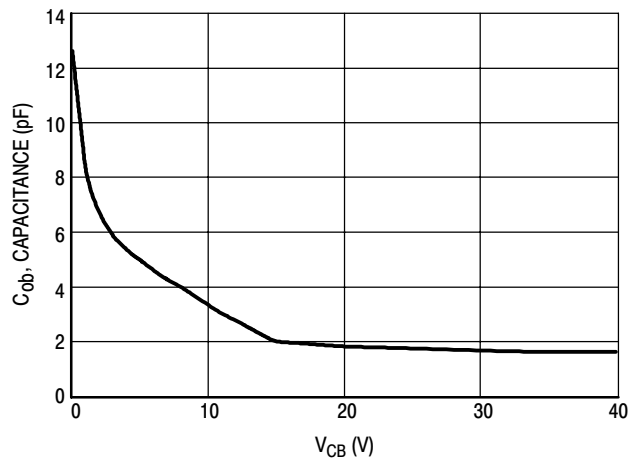
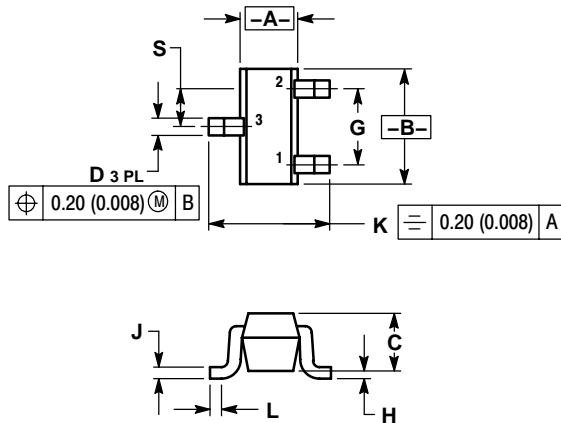

Figure 6. Capacitance

2SA1774

PACKAGE DIMENSIONS

SC-75/SOT-416 CASE 463-01 ISSUE C



NOTES:

1. DIMENSIONING AND TOLERANCING PER ANSI Y14.5M, 1982.
2. CONTROLLING DIMENSION: MILLIMETER.

DIM	MILLIMETERS		INCHES	
	MIN	MAX	MIN	MAX
A	0.70	0.90	0.028	0.035
B	1.40	1.80	0.055	0.071
C	0.60	0.90	0.024	0.035
D	0.15	0.30	0.006	0.012
G	1.00 BSC		0.039 BSC	
H	---	0.10	---	0.004
J	0.10	0.25	0.004	0.010
K	1.45	1.75	0.057	0.069
L	0.10	0.20	0.004	0.008
S	0.50 BSC		0.020 BSC	

STYLE 1:

1. BASE
2. EMITTER
3. COLLECTOR

ON Semiconductor and  are registered trademarks of Semiconductor Components Industries, LLC (SCILLC). SCILLC reserves the right to make changes without further notice to any products herein. SCILLC makes no warranty, representation or guarantee regarding the suitability of its products for any particular purpose, nor does SCILLC assume any liability arising out of the application or use of any product or circuit, and specifically disclaims any and all liability, including without limitation special, consequential or incidental damages. "Typical" parameters which may be provided in SCILLC data sheets and/or specifications can and do vary in different applications and actual performance may vary over time. All operating parameters, including "Typicals" must be validated for each customer application by customer's technical experts. SCILLC does not convey any license under its patent rights nor the rights of others. SCILLC products are not designed, intended, or authorized for use as components in systems intended for surgical implant into the body, or other applications intended to support or sustain life, or for any other application in which the failure of the SCILLC product could create a situation where personal injury or death may occur. Should Buyer purchase or use SCILLC products for any such unintended or unauthorized application, Buyer shall indemnify and hold SCILLC and its officers, employees, subsidiaries, affiliates, and distributors harmless against all claims, costs, damages, and expenses, and reasonable attorney fees arising out of, directly or indirectly, any claim of personal injury or death associated with such unintended or unauthorized use, even if such claim alleges that SCILLC was negligent regarding the design or manufacture of the part. SCILLC is an Equal Opportunity/Affirmative Action Employer. This literature is subject to all applicable copyright laws and is not for resale in any manner.

PUBLICATION ORDERING INFORMATION

LITERATURE FULFILLMENT:
Literature Distribution Center for ON Semiconductor
P.O. Box 5163, Denver, Colorado 80217 USA
Phone: 303-675-2175 or 800-344-3860 Toll Free USA/Canada
Fax: 303-675-2176 or 800-344-3867 Toll Free USA/Canada
Email: orderlit@onsemi.com

N. American Technical Support: 800-282-9855 Toll Free
USA/Canada

Japan: ON Semiconductor, Japan Customer Focus Center
2-9-1 Kamimeguro, Meguro-ku, Tokyo, Japan 153-0051
Phone: 81-3-5773-3850

ON Semiconductor Website: <http://onsemi.com>

Order Literature: <http://www.onsemi.com/litorder>

For additional information, please contact your local Sales Representative.

This datasheet has been download from:

www.datasheetcatalog.com

Datasheets for electronics components.