

MC10H131

Dual D Type Master-Slave Flip-Flop

Description

The MC10H131 is a MECL 10H™ part which is a functional/pinout duplication of the standard MECL 10K™ family part, with 100% improvement in clock speed and propagation delay and no increase in power-supply current.

Features

- Propagation Delay, 1.0 ns Typical
- Power Dissipation, 235 mW Typical
- Improved Noise Margin 150 mV (Over Operating Voltage and Temperature Range)
- Voltage Compensated
- MECL 10K Compatible
- Pb-Free Packages are Available*



ON Semiconductor®

<http://onsemi.com>

MARKING DIAGRAMS*

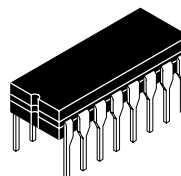

**CDIP-16
L SUFFIX
CASE 620A**

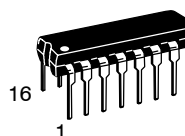
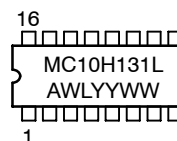

**PDIP-16
P SUFFIX
CASE 648**

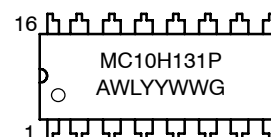

**SOEIAJ-16
CASE 966**

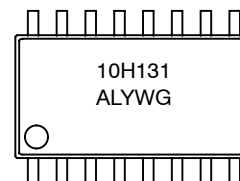

**PLLC-20
FN SUFFIX
CASE 775**

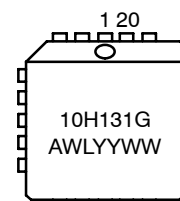

A = Assembly Location
WL, L = Wafer Lot
YY, Y = Year
WW, W = Work Week
G = Pb-Free Package

*For additional information on our Pb-Free strategy and soldering details, please download the ON Semiconductor Soldering and Mounting Techniques Reference Manual, SOLDERRM/D.

*For additional marking information, refer to Application Note AND8002/D.

ORDERING INFORMATION

See detailed ordering and shipping information in the package dimensions section on page 4 of this data sheet.

MC10H131

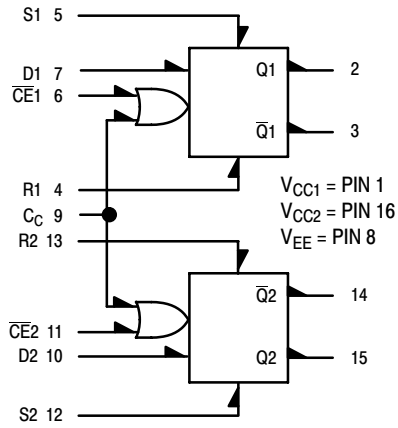
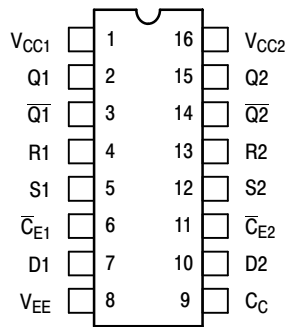

Figure 1. Logic Diagram



Pin assignment is for Dual-in-Line Package.

Figure 2. Pin Assignment

Table 1. RS TRUTH TABLE

| R | S | Q_{n+1} |
|---|---|-----------|
| L | L | Q_n |
| L | H | H |
| H | L | L |
| H | H | ND |

ND = Not Defined

Table 2. CLOCKED TRUTH TABLE

| C | D | Q_{n+1} |
|---|---|-----------|
| L | X | Q_n |
| H | L | L |
| H | H | H |

$$C = \overline{CE} + C_C$$

A clock H is a clock transition from a low to a high state.

Table 3. MAXIMUM RATINGS

| Symbol | Characteristic | Rating | Unit |
|-----------|-----------------------------------------------------|----------------------------|----------|
| V_{EE} | Power Supply ($V_{CC} = 0$) | -8.0 to 0 | Vdc |
| V_I | Input Voltage ($V_{CC} = 0$) | 0 to V_{EE} | Vdc |
| I_{out} | Output Current - Continuous - Surge | 50 100 | mA |
| T_A | Operating Temperature Range | 0 to +75 | °C |
| T_{stg} | Storage Temperature Range - Plastic - Ceramic | -55 to +150 -55 to +165 | °C °C |

Maximum ratings are those values beyond which device damage can occur. Maximum ratings applied to the device are individual stress limit values (not normal operating conditions) and are not valid simultaneously. If these limits are exceeded, device functional operation is not implied, damage may occur and reliability may be affected.

MC10H131

Table 4. ELECTRICAL CHARACTERISTICS ($V_{EE} = -5.2\text{ V} \pm 5\%$) (Note 1)

| Symbol | Characteristic | 0° | | 25° | | 75° | | Unit |
|-----------|----------------------|-------|-------|-------|-------|-------|--------|---------------|
| | | Min | Max | Min | Max | Min | Max | |
| I_E | Power Supply Current | – | 62 | – | 56 | – | 62 | mA |
| I_{inH} | Input Current High | | | | | | | μA |
| | Pins 6, 11 | – | 530 | – | 310 | – | 310 | |
| | Pin 9 | – | 660 | – | 390 | – | 390 | |
| | Pins 7, 10 | – | 485 | – | 285 | – | 285 | |
| | Pins 4, 5, 12, 13 | – | 790 | – | 465 | – | 465 | |
| I_{inL} | Input Current Low | 0.5 | – | 0.5 | – | 0.3 | – | μA |
| V_{OH} | High Output Voltage | –1.02 | –0.84 | –0.98 | –0.81 | –0.92 | –0.735 | Vdc |
| V_{OL} | Low Output Voltage | –1.95 | –1.63 | –1.95 | –1.63 | –1.95 | –1.60 | Vdc |
| V_{IH} | High Input Voltage | –1.17 | –0.84 | –1.13 | –0.81 | –1.07 | –0.735 | Vdc |
| V_{IL} | Low Input Voltage | –1.95 | –1.48 | –1.95 | –1.48 | –1.95 | –1.45 | Vdc |

1. Each MECL 10H series circuit has been designed to meet the dc specifications shown in the test table, after thermal equilibrium has been established. The circuit is in a test socket or mounted on a printed circuit board and transverse air flow greater than 500 linear fpm is maintained. Outputs are terminated through a 50 Ω resistor to -2.0 V .

Table 5. AC CHARACTERISTICS

| Symbol | Characteristic | 0° | | 25° | | 75° | | Unit |
|------------|------------------------|-----|-----|-----|-----|-----|-----|------|
| | | Min | Max | Min | Max | Min | Max | |
| t_{pd} | Propagation Delay | | | | | | | ns |
| | Clock, \overline{CE} | 0.8 | 1.6 | 0.8 | 1.7 | 0.8 | 1.8 | |
| | Set, Reset | 0.6 | 1.6 | 0.7 | 1.7 | 0.7 | 1.8 | |
| t_r | Rise Time | 0.6 | 2.0 | 0.6 | 2.0 | 0.6 | 2.2 | ns |
| t_f | Fall Time | 0.6 | 2.0 | 0.6 | 2.0 | 0.6 | 2.2 | ns |
| t_{set} | Set-up Time | 0.7 | – | 0.7 | – | 0.7 | – | ns |
| t_{hold} | Hold Time | 0.8 | – | 0.8 | – | 0.8 | – | ns |
| f_{tog} | Toggle Frequency | 250 | – | 250 | – | 250 | – | MHz |

NOTE: Device will meet the specifications after thermal equilibrium has been established when mounted in a test socket or printed circuit board with maintained transverse airflow greater than 500 lfpm. Electrical parameters are guaranteed only over the declared operating temperature range. Functional operation of the device exceeding these conditions is not implied. Device specification limit values are applied individually under normal operating conditions and not valid simultaneously.

APPLICATION INFORMATION

The MC10H131 is a dual master–slave type D flip–flop. Asynchronous Set (S) and Reset (R) override Clock (C_C) and Clock Enable (\overline{CE}) inputs. Each flip–flop may be clocked separately by holding the common clock in the new low state and using the enable inputs for the clocking function. If the common clock is to be used to clock the flip–flop, the Clock Enable inputs must be in the low state.

In this case, the enable inputs perform the function of controlling the common clock.

The output states of the flip–flop change on the positive transition of the clock. A change in the information present at the data (D) input will not affect the output information at any other time due to master slave construction.

MC10H131

ORDERING INFORMATION

| Device | Package | Shipping† |
|---------------|------------------------|--------------------|
| MC10H131FN | PLLC-20 | 46 Units / Rail |
| MC10H131FNG | PLLC-20 (Pb-Free) | 46 Units / Rail |
| MC10H131FNR2 | PLLC-20 | 500 / Tape & Reel |
| MC10H131FNR2G | PLLC-20 (Pb-Free) | 500 / Tape & Reel |
| MC10H131L | CDIP-16 | 25 Unit / Rail |
| MC10H131M | SOEIAJ-16 | 50 Unit / Rail |
| MC10H131MG | SOEIAJ-16 (Pb-Free) | 50 Unit / Rail |
| MC10H131MEL | SOEIAJ-16 | 2000 / Tape & Reel |
| MC10H131MELG | SOEIAJ-16 (Pb-Free) | 2000 / Tape & Reel |
| MC10H131P | PDIP-16 | 25 Unit / Rail |
| MC10H131PG | PDIP-16 (Pb-Free) | 25 Unit / Rail |

†For information on tape and reel specifications, including part orientation and tape sizes, please refer to our Tape and Reel Packaging Specifications Brochure, BRD8011/D.

MC10H131

PACKAGE DIMENSIONS

20 LEAD PLLC
CASE 775-02
ISSUE E



NOTES:

1. DIMENSIONS AND TOLERANCING PER ANSI Y14.5M, 1982.
2. DIMENSIONS IN INCHES.
3. DATUMS -L-, -M-, AND -N- DETERMINED WHERE TOP OF LEAD SHOULDER EXITS PLASTIC BODY AT MOLD PARTING LINE.
4. DIMENSION G1, TRUE POSITION TO BE MEASURED AT DATUM -T-, SEATING PLANE.
5. DIMENSIONS R AND U DO NOT INCLUDE MOLD FLASH. ALLOWABLE MOLD FLASH IS 0.010 (0.250) PER SIDE.
6. DIMENSIONS IN THE PACKAGE TOP MAY BE SMALLER THAN THE PACKAGE BOTTOM BY UP TO 0.012 (0.300). DIMENSIONS R AND U ARE DETERMINED AT THE OUTERMOST EXTREMES OF THE PLASTIC BODY EXCLUSIVE OF MOLD FLASH, TIE BAR BURRS, GATE BURRS AND INTERLEAD FLASH, BUT INCLUDING ANY MISMATCH BETWEEN THE TOP AND BOTTOM OF THE PLASTIC BODY.
7. DIMENSION H DOES NOT INCLUDE DAMBAR PROTRUSION OR INTRUSION. THE DAMBAR PROTRUSION(S) SHALL NOT CAUSE THE H DIMENSION TO BE GREATER THAN 0.037 (0.940). THE DAMBAR INTRUSION(S) SHALL NOT CAUSE THE H DIMENSION TO BE SMALLER THAN 0.025 (0.635).

| DIM | INCHES | | MILLIMETERS | |
|-----|-----------|-------|-------------|-------|
| | MIN | MAX | MIN | MAX |
| A | 0.385 | 0.395 | 9.78 | 10.03 |
| B | 0.385 | 0.395 | 9.78 | 10.03 |
| C | 0.165 | 0.180 | 4.20 | 4.57 |
| E | 0.090 | 0.110 | 2.29 | 2.79 |
| F | 0.013 | 0.019 | 0.33 | 0.48 |
| G | 0.050 BSC | | 1.27 BSC | |
| H | 0.026 | 0.032 | 0.66 | 0.81 |
| J | 0.020 | --- | 0.51 | --- |
| K | 0.025 | --- | 0.64 | --- |
| R | 0.350 | 0.356 | 8.89 | 9.04 |
| U | 0.350 | 0.356 | 8.89 | 9.04 |
| V | 0.042 | 0.048 | 1.07 | 1.21 |
| W | 0.042 | 0.048 | 1.07 | 1.21 |
| X | 0.042 | 0.056 | 1.07 | 1.42 |
| Y | --- | 0.020 | --- | 0.50 |
| Z | 2° | 10° | 2° | 10° |
| G1 | 0.310 | 0.330 | 7.88 | 8.38 |
| K1 | 0.040 | --- | 1.02 | --- |

MC10H131

PACKAGE DIMENSIONS

SOEIAJ-16 CASE 966-01 ISSUE A



NOTES:

1. DIMENSIONING AND TOLERANCING PER ANSI Y14.5M, 1982.
2. CONTROLLING DIMENSION: MILLIMETER.
3. DIMENSIONS D AND E DO NOT INCLUDE MOLD FLASH OR PROTRUSIONS AND ARE MEASURED AT THE PARTING LINE. MOLD FLASH OR PROTRUSIONS SHALL NOT EXCEED 0.15 (0.006) PER SIDE.
4. TERMINAL NUMBERS ARE SHOWN FOR REFERENCE ONLY.
5. THE LEAD WIDTH DIMENSION (b) DOES NOT INCLUDE DAMBAR PROTRUSION. ALLOWABLE DAMBAR PROTRUSION SHALL BE 0.08 (0.003) TOTAL IN EXCESS OF THE LEAD WIDTH DIMENSION AT MAXIMUM MATERIAL CONDITION. DAMBAR CANNOT BE LOCATED ON THE LOWER RADIUS OR THE FOOT. MINIMUM SPACE BETWEEN PROTRUSIONS AND ADJACENT LEAD TO BE 0.46 (0.018).

| DIM | MILLIMETERS | | INCHES | |
|----------------|-------------|-------|--------|-------|
| | MIN | MAX | MIN | MAX |
| A | --- | 2.05 | --- | 0.081 |
| A ₁ | 0.05 | 0.20 | 0.002 | 0.008 |
| b | 0.35 | 0.50 | 0.014 | 0.020 |
| c | 0.10 | 0.20 | 0.007 | 0.011 |
| D | 9.90 | 10.50 | 0.390 | 0.413 |
| E | 5.10 | 5.45 | 0.201 | 0.215 |
| e | 1.27 BSC | | | |
| HE | 7.40 | 8.20 | 0.291 | 0.323 |
| L | 0.50 | 0.85 | 0.020 | 0.033 |
| LE | 1.10 | 1.50 | 0.043 | 0.059 |
| M | 0° | 10° | 0° | 10° |
| Q ₁ | 0.70 | 0.90 | 0.028 | 0.035 |
| Z | --- | 0.78 | --- | 0.031 |

CDIP-16 L SUFFIX CERAMIC DIP PACKAGE CASE 620A-01 ISSUE O

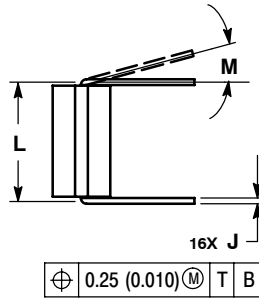

NOTES:

1. DIMENSIONING AND TOLERANCING PER ASME Y14.5M, 1994.
2. CONTROLLING DIMENSION: INCH.
3. DIMENSION L TO CENTER OF LEAD WHEN FORMED PARALLEL.
4. DIMENSION F MAY NARROW TO 0.76 (0.030) WHERE THE LEAD ENTERS THE CERAMIC BODY.
5. THIS DRAWING REPLACES OBSOLETE CASE OUTLINE 620-10.

| DIM | INCHES | | MILLIMETERS | |
|-----|-----------|-------|-------------|-------|
| | MIN | MAX | MIN | MAX |
| A | 0.750 | 0.785 | 19.05 | 19.93 |
| B | 0.240 | 0.295 | 6.10 | 7.49 |
| C | --- | 0.200 | --- | 5.08 |
| D | 0.015 | 0.020 | 0.39 | 0.50 |
| E | 0.050 BSC | | | |
| F | 0.055 | 0.065 | 1.40 | 1.65 |
| G | 0.100 BSC | | | |
| H | 0.008 | 0.015 | 0.21 | 0.38 |
| K | 0.125 | 0.170 | 3.18 | 4.31 |
| L | 0.300 BSC | | | |
| M | 0° | 15° | 0° | 15° |
| N | 0.020 | 0.040 | 0.51 | 1.01 |

MC10H131

PACKAGE DIMENSIONS

PDIP-16 P SUFFIX PLASTIC DIP PACKAGE CASE 648-08 ISSUE R

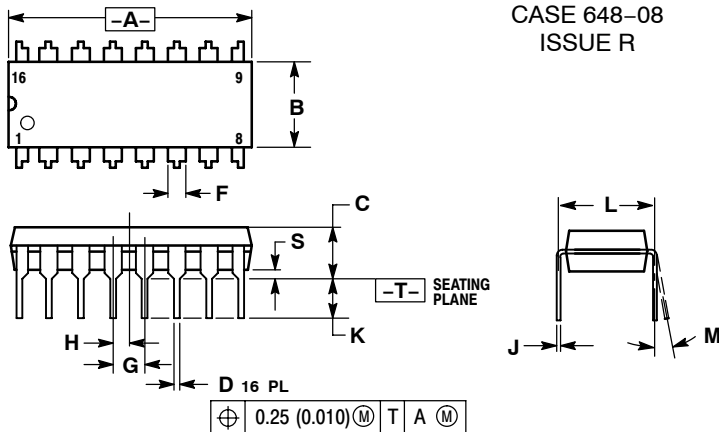

NOTES:

1. DIMENSIONING AND TOLERANCING PER ANSI Y14.5M, 1982.
2. CONTROLLING DIMENSION: INCH.
3. DIMENSION L TO CENTER OF LEADS WHEN FORMED PARALLEL.
4. DIMENSION B DOES NOT INCLUDE MOLD FLASH.
5. ROUNDED CORNERS OPTIONAL.

| DIM | INCHES | | MILLIMETERS | |
|-----|-----------|-------|-------------|-------|
| | MIN | MAX | MIN | MAX |
| A | 0.740 | 0.770 | 18.80 | 19.55 |
| B | 0.250 | 0.270 | 6.35 | 6.85 |
| C | 0.145 | 0.175 | 3.69 | 4.44 |
| D | 0.015 | 0.021 | 0.39 | 0.53 |
| F | 0.040 | 0.70 | 1.02 | 1.77 |
| G | 0.100 BSC | | 2.54 BSC | |
| H | 0.050 BSC | | 1.27 BSC | |
| J | 0.008 | 0.015 | 0.21 | 0.38 |
| K | 0.110 | 0.130 | 2.80 | 3.30 |
| L | 0.295 | 0.305 | 7.50 | 7.74 |
| M | 0° | 10° | 0° | 10° |
| S | 0.020 | 0.040 | 0.51 | 1.01 |

MECL 10H and MECL 10K are trademarks of Motorola, Inc.

ON Semiconductor and  are registered trademarks of Semiconductor Components Industries, LLC (SCILLC). SCILLC reserves the right to make changes without further notice to any products herein. SCILLC makes no warranty, representation or guarantee regarding the suitability of its products for any particular purpose, nor does SCILLC assume any liability arising out of the application or use of any product or circuit, and specifically disclaims any and all liability, including without limitation special, consequential or incidental damages. "Typical" parameters which may be provided in SCILLC data sheets and/or specifications can and do vary in different applications and actual performance may vary over time. All operating parameters, including "Typicals" must be validated for each customer application by customer's technical experts. SCILLC does not convey any license under its patent rights nor the rights of others. SCILLC products are not designed, intended, or authorized for use as components in systems intended for surgical implant into the body, or other applications intended to support or sustain life, or for any other application in which the failure of the SCILLC product could create a situation where personal injury or death may occur. Should Buyer purchase or use SCILLC products for any such unintended or unauthorized application, Buyer shall indemnify and hold SCILLC and its officers, employees, subsidiaries, affiliates, and distributors harmless against all claims, costs, damages, and expenses, and reasonable attorney fees arising out of, directly or indirectly, any claim of personal injury or death associated with such unintended or unauthorized use, even if such claim alleges that SCILLC was negligent regarding the design or manufacture of the part. SCILLC is an Equal Opportunity/Affirmative Action Employer. This literature is subject to all applicable copyright laws and is not for resale in any manner.

PUBLICATION ORDERING INFORMATION

LITERATURE FULFILLMENT:
Literature Distribution Center for ON Semiconductor
P.O. Box 61312, Phoenix, Arizona 85082-1312 USA
Phone: 480-829-7710 or 800-344-3860 Toll Free USA/Canada
Fax: 480-829-7709 or 800-344-3867 Toll Free USA/Canada
Email: orderlit@onsemi.com

N. American Technical Support: 800-282-9855 Toll Free USA/Canada

Japan: ON Semiconductor, Japan Customer Focus Center
2-9-1 Kamimeguro, Meguro-ku, Tokyo, Japan 153-0051
Phone: 81-3-5773-3850

ON Semiconductor Website: <http://onsemi.com>

Order Literature: <http://www.onsemi.com/litorder>

For additional information, please contact your local Sales Representative.