

MJD200 (NPN) MJD210 (PNP)

Complementary Plastic Power Transistors

NPN/PNP Silicon DPAK For Surface Mount Applications

Designed for low voltage, low-power, high-gain audio amplifier applications.

Features

- Collector–Emitter Sustaining Voltage –
 $V_{CE(sus)} = 25 \text{ Vdc (Min) @ } I_C = 10 \text{ mAdc}$
- High DC Current Gain – $h_{FE} = 70 \text{ (Min) @ } I_C = 500 \text{ mAdc}$
 $= 45 \text{ (Min) @ } I_C = 2 \text{ Adc}$
 $= 10 \text{ (Min) @ } I_C = 5 \text{ Adc}$
- Lead Formed for Surface Mount Applications in Plastic Sleeves (No Suffix)
- Low Collector–Emitter Saturation Voltage –
 $V_{CE(sat)} = 0.3 \text{ Vdc (Max) @ } I_C = 500 \text{ mAdc}$
 $= 0.75 \text{ Vdc (Max) @ } I_C = 2.0 \text{ Adc}$
- High Current–Gain – Bandwidth Product –
 $f_T = 65 \text{ MHz (Min) @ } I_C = 100 \text{ mAdc}$
- Annular Construction for Low Leakage –
 $I_{CBO} = 100 \text{ nAdc @ Rated } V_{CB}$
- Epoxy Meets UL 94 V–0 @ 0.125 in
- ESD Ratings: Human Body Model, 3B > 8000 V
Machine Model, C > 400 V
- Pb–Free Packages are Available

MAXIMUM RATINGS

Rating	Symbol	Max	Unit
Collector–Base Voltage	V_{CB}	40	Vdc
Collector–Emitter Voltage	V_{CEO}	25	Vdc
Emitter–Base Voltage	V_{EB}	8.0	Vdc
Collector Current – Continuous – Peak	I_C	5.0 10	Adc
Base Current	I_B	1.0	Adc
Total Power Dissipation @ $T_C = 25^\circ\text{C}$ Derate above 25°C	P_D	12.5 0.1	W W/ $^\circ\text{C}$
Total Power Dissipation (Note 1) @ $T_A = 25^\circ\text{C}$ Derate above 25°C	P_D	1.4 0.011	W W/ $^\circ\text{C}$
Operating and Storage Junction Temperature Range	T_J, T_{stg}	–65 to +150	$^\circ\text{C}$

Stresses exceeding Maximum Ratings may damage the device. Maximum Ratings are stress ratings only. Functional operation above the Recommended Operating Conditions is not implied. Extended exposure to stresses above the Recommended Operating Conditions may affect device reliability.

1. These ratings are applicable when surface mounted on the minimum pad sizes recommended.



ON Semiconductor®

<http://onsemi.com>

**SILICON
POWER TRANSISTORS
5 AMPERES
25 VOLTS, 12.5 WATTS**

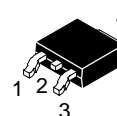

**DPAK
CASE 369C
STYLE 1**

MARKING DIAGRAM

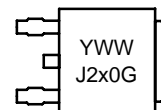

Y = Year
WW = Work Week
x = 1 or 0
G = Pb–Free Package

ORDERING INFORMATION

See detailed ordering and shipping information in the package dimensions section on page 2 of this data sheet.

MJD200 (NPN) MJD210 (PNP)

THERMAL CHARACTERISTICS

Characteristic	Symbol	Max	Unit
Thermal Resistance, Junction-to-Case	$R_{\theta JC}$	10	$^{\circ}\text{C/W}$
Thermal Resistance, Junction-to-Ambient (Note 2)	$R_{\theta JA}$	89.3	$^{\circ}\text{C/W}$

2. These ratings are applicable when surface mounted on the minimum pad sizes recommended.

ELECTRICAL CHARACTERISTICS ($T_C = 25^{\circ}\text{C}$ unless otherwise noted)

Characteristic	Symbol	Min	Max	Unit
----------------	--------	-----	-----	------

OFF CHARACTERISTICS

Collector-Emitter Sustaining Voltage (Note 3), ($I_C = 10 \text{ mAdc}$, $I_B = 0$)	$V_{CE(sus)}$	25	–	Vdc
Collector Cutoff Current ($V_{CB} = 40 \text{ Vdc}$, $I_E = 0$) ($V_{CB} = 40 \text{ Vdc}$, $I_E = 0$, $T_J = 125^{\circ}\text{C}$)	V_{CBO}	–	100	nAdc μAdc
Emitter Cutoff Current ($V_{BE} = 8 \text{ Vdc}$, $I_C = 0$)	V_{EBO}	–	100	nAdc

ON CHARACTERISTICS

DC Current Gain (Note 3), ($I_C = 500 \text{ mAdc}$, $V_{CE} = 1 \text{ Vdc}$) ($I_C = 2 \text{ Adc}$, $V_{CE} = 1 \text{ Vdc}$) ($I_C = 5 \text{ Adc}$, $V_{CE} = 2 \text{ Vdc}$)	h_{FE}	70 45 10	– 180 –	–
Collector-Emitter Saturation Voltage (Note 3) ($I_C = 500 \text{ mAdc}$, $I_B = 50 \text{ mAdc}$) ($I_C = 2 \text{ Adc}$, $I_B = 200 \text{ mAdc}$) ($I_C = 5 \text{ Adc}$, $I_B = 1 \text{ Adc}$)	$V_{CE(sat)}$	– – –	0.3 0.75 1.8	Vdc
Base-Emitter Saturation Voltage (Note 3), ($I_C = 5 \text{ Adc}$, $I_B = 1 \text{ Adc}$)	$V_{BE(sat)}$	–	2.5	Vdc
Base-Emitter On Voltage (Note 3), ($I_C = 2 \text{ Adc}$, $V_{CE} = 1 \text{ Vdc}$)	$V_{BE(on)}$	–	1.6	Vdc

DYNAMIC CHARACTERISTICS

Current-Gain – Bandwidth Product (Note 4) ($I_C = 100 \text{ mAdc}$, $V_{CE} = 10 \text{ Vdc}$, $f_{test} = 10 \text{ MHz}$)	f_T	65	–	MHz
Output Capacitance ($V_{CB} = 10 \text{ Vdc}$, $I_E = 0$, $f = 0.1 \text{ MHz}$)	C_{ob}	–	80 120	pF

3. Pulse Test: Pulse Width = 300 μs , Duty Cycle $\approx 2\%$.

4. $f_T = |h_{fe}| \cdot f_{test}$.

ORDERING INFORMATION

Device	Package Type	Shipping†
MJD200	DPAK	75 Units / Rail
MJD200G	DPAK (Pb-Free)	
MJD200RL	DPAK	1800 / Tape & Reel
MJD200RLG	DPAK (Pb-Free)	
MJD200T4	DPAK	2500 / Tape & Reel
MJD200T4G	DPAK (Pb-Free)	
MJD210	DPAK	75 Units / Rail
MJD210G	DPAK (Pb-Free)	
MJD210RL	DPAK	1800 / Tape & Reel
MJD210RLG	DPAK (Pb-Free)	
MJD210T4	DPAK	2500 / Tape & Reel
MJD210T4G	DPAK (Pb-Free)	

†For information on tape and reel specifications, including part orientation and tape sizes, please refer to our Tape and Reel Packaging Specifications Brochure, BRD8011/D.

MJD200 (NPN) MJD210 (PNP)

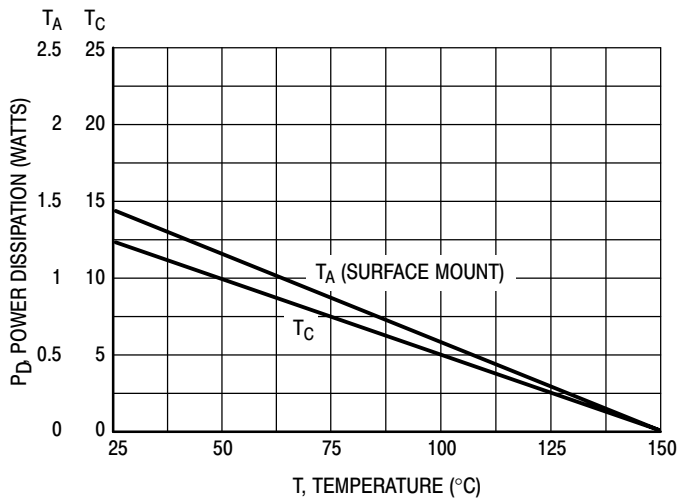
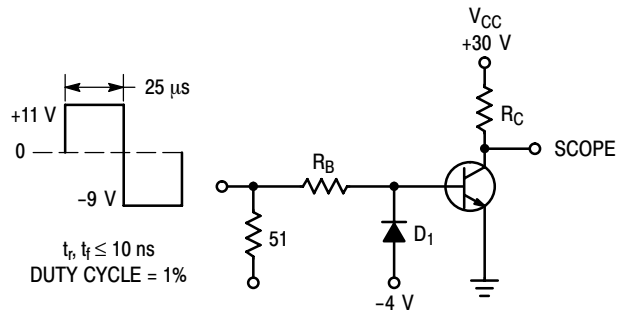

Figure 1. Power Derating



R_B and R_C VARIED TO OBTAIN DESIRED CURRENT LEVELS
 D_1 MUST BE FAST RECOVERY TYPE, e.g.:
 1N5825 USED ABOVE $I_B \approx 100$ mA FOR PNP TEST CIRCUIT,
 MSD6100 USED BELOW $I_B \approx 100$ mA REVERSE ALL POLARITIES

Figure 2. Switching Time Test Circuit

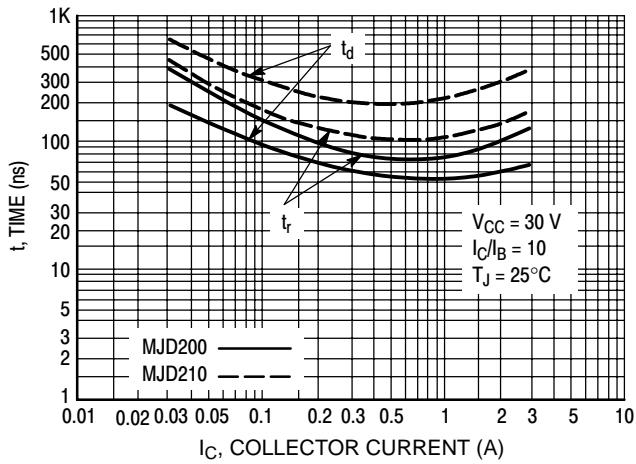

Figure 3. Turn-On Time

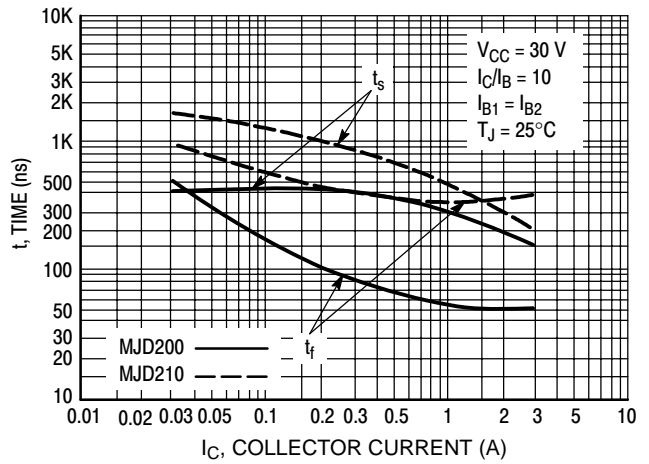

Figure 4. Turn-Off Time

MJD200 (NPN) MJD210 (PNP)

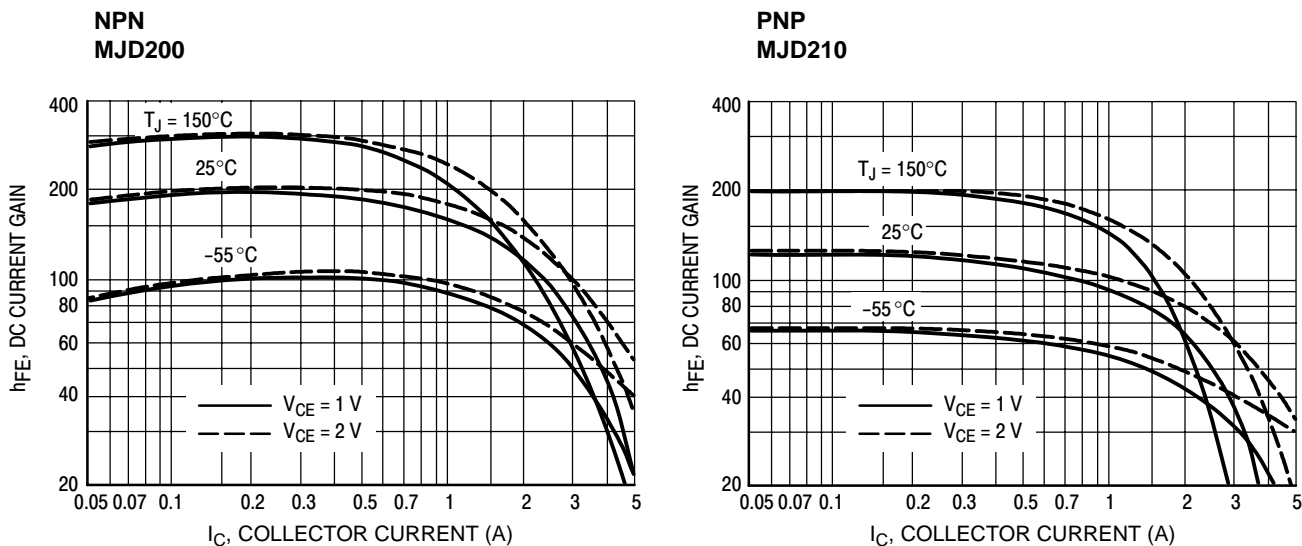

Figure 5. DC Current Gain

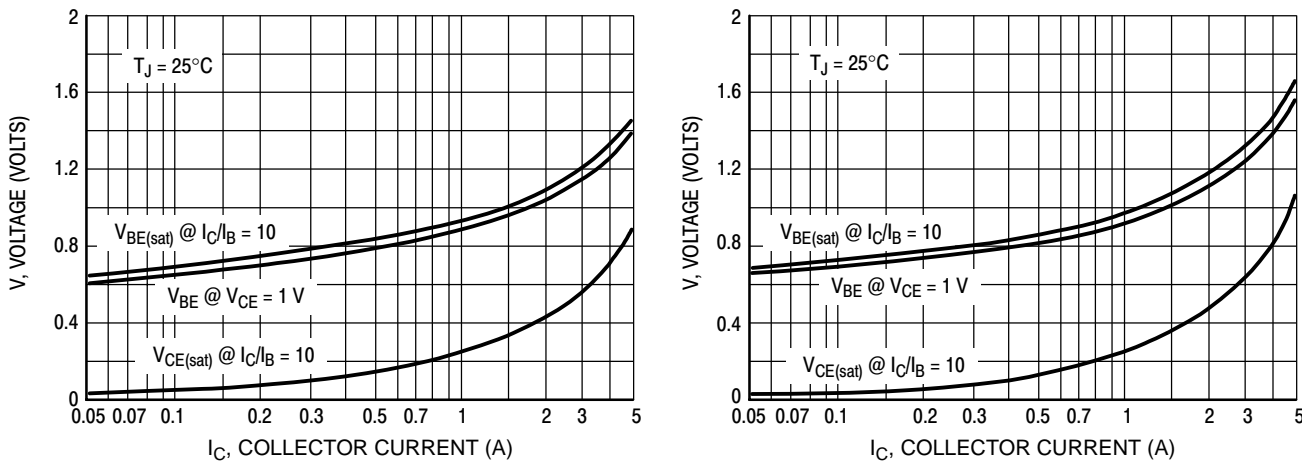

Figure 6. "On" Voltage

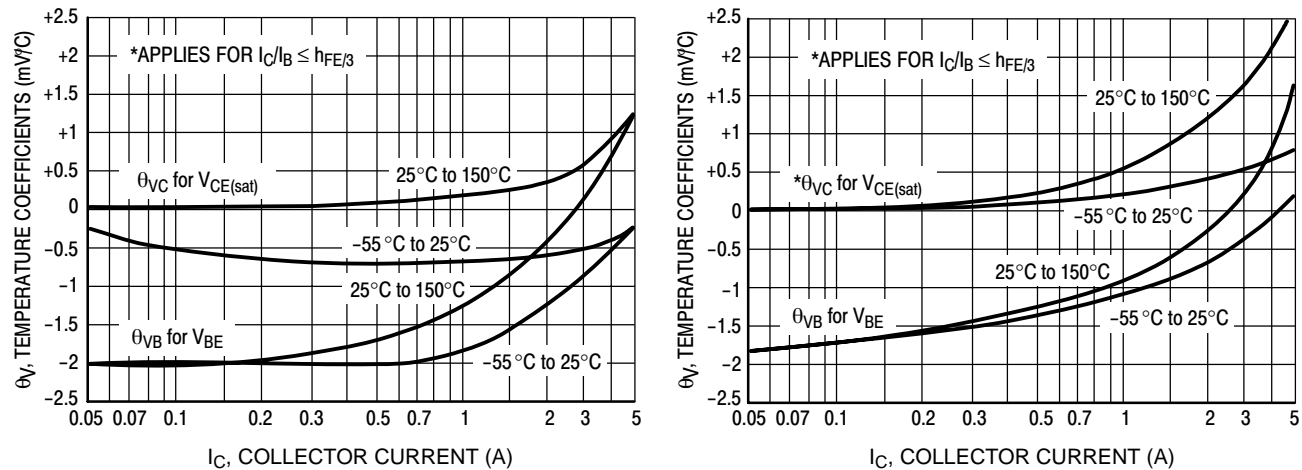

Figure 7. Temperature Coefficients

MJD200 (NPN) MJD210 (PNP)

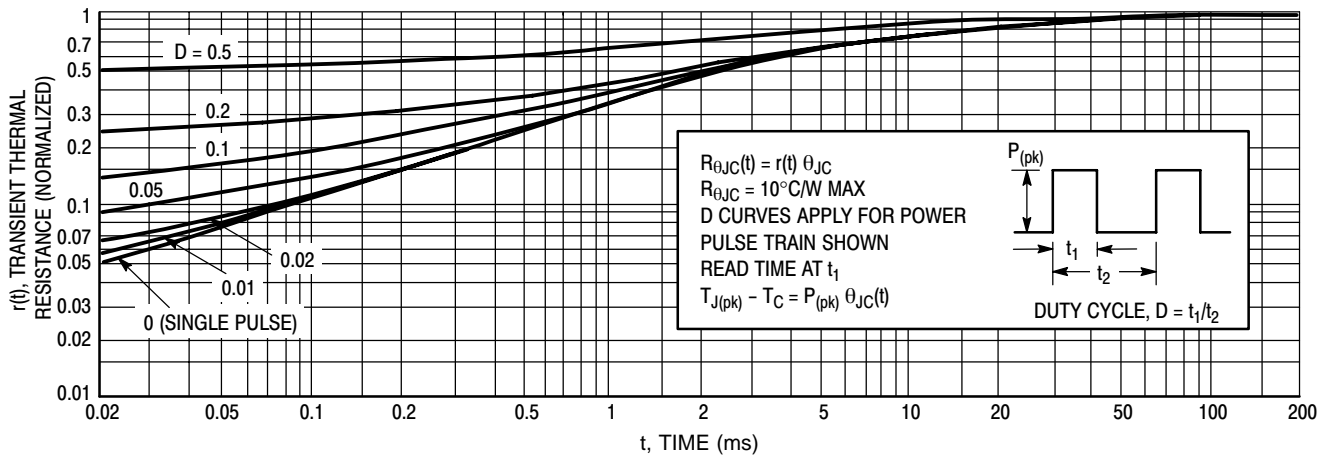

Figure 8. Thermal Response

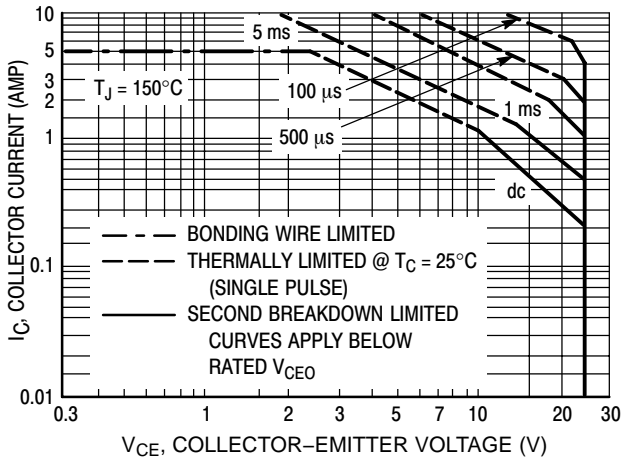

Figure 9. Active Region Safe Operating Area

There are two limitations on the power handling ability of a transistor: average junction temperature and second breakdown. Safe operating area curves indicate $I_C - V_{CE}$ limits of the transistor that must be observed for reliable operation; i.e., the transistor must not be subjected to greater dissipation than the curves indicate.

The data of Figure 9 is based on $T_{J(pk)} = 150^{\circ}\text{C}$; T_C is variable depending on conditions. Second breakdown pulse limits are valid for duty cycles to 10% provided $T_{J(pk)} \leq 150^{\circ}\text{C}$. $T_{J(pk)}$ may be calculated from the data in Figure 8. At high case temperatures, thermal limitations will reduce the power that can be handled to values less than the limitations imposed by second breakdown.

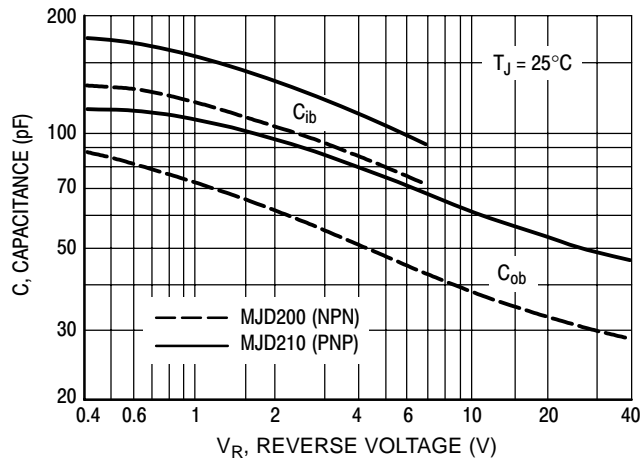
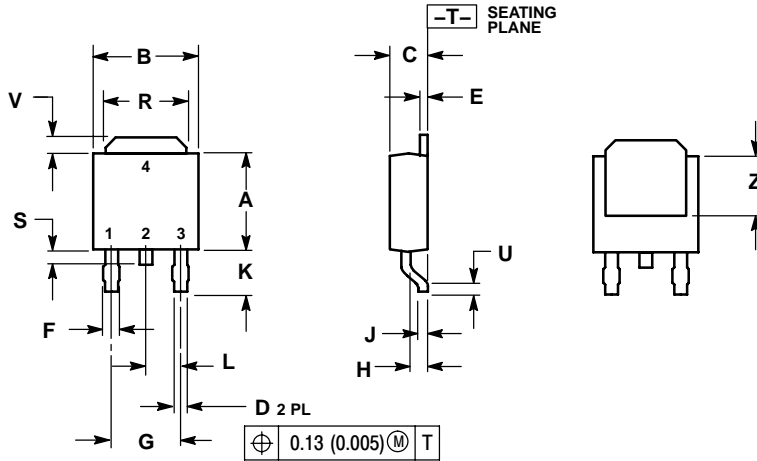

Figure 10. Capacitance

MJD200 (NPN) MJD210 (PNP)

PACKAGE DIMENSIONS

DPAK CASE 369C ISSUE O



- NOTES:
 1. DIMENSIONING AND TOLERANCING PER ANSI Y14.5M, 1982.
 2. CONTROLLING DIMENSION: INCH.

DIM	INCHES		MILLIMETERS	
	MIN	MAX	MIN	MAX
A	0.235	0.245	5.97	6.22
B	0.250	0.265	6.35	6.73
C	0.086	0.094	2.19	2.38
D	0.027	0.035	0.69	0.88
E	0.018	0.023	0.46	0.58
F	0.037	0.045	0.94	1.14
G	0.180 BSC		4.58 BSC	
H	0.034	0.040	0.87	1.01
J	0.018	0.023	0.46	0.58
K	0.102	0.114	2.60	2.89
L	0.090 BSC		2.29 BSC	
R	0.180	0.215	4.57	5.45
S	0.025	0.040	0.63	1.01
U	0.020	---	0.51	---
V	0.035	0.050	0.89	1.27
Z	0.155	---	3.93	---

- STYLE 1:
 PIN 1. BASE
 2. COLLECTOR
 3. EMITTER
 4. COLLECTOR

SOLDERING FOOTPRINT*

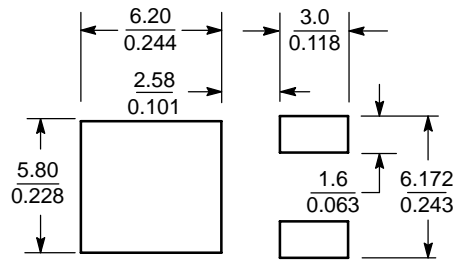

SCALE 3:1 $\left(\frac{\text{mm}}{\text{inches}}\right)$

*For additional information on our Pb-Free strategy and soldering details, please download the ON Semiconductor Soldering and Mounting Techniques Reference Manual, SOLDERRM/D.

ON Semiconductor and are registered trademarks of Semiconductor Components Industries, LLC (SCILLC). SCILLC reserves the right to make changes without further notice to any products herein. SCILLC makes no warranty, representation or guarantee regarding the suitability of its products for any particular purpose, nor does SCILLC assume any liability arising out of the application or use of any product or circuit, and specifically disclaims any and all liability, including without limitation special, consequential or incidental damages. "Typical" parameters which may be provided in SCILLC data sheets and/or specifications can and do vary in different applications and actual performance may vary over time. All operating parameters, including "Typicals" must be validated for each customer application by customer's technical experts. SCILLC does not convey any license under its patent rights nor the rights of others. SCILLC products are not designed, intended, or authorized for use as components in systems intended for surgical implant into the body, or other applications intended to support or sustain life, or for any other application in which the failure of the SCILLC product could create a situation where personal injury or death may occur. Should Buyer purchase or use SCILLC products for any such unintended or unauthorized application, Buyer shall indemnify and hold SCILLC and its officers, employees, subsidiaries, affiliates, and distributors harmless against all claims, costs, damages, and expenses, and reasonable attorney fees arising out of, directly or indirectly, any claim of personal injury or death associated with such unintended or unauthorized use, even if such claim alleges that SCILLC was negligent regarding the design or manufacture of the part. SCILLC is an Equal Opportunity/Affirmative Action Employer. This literature is subject to all applicable copyright laws and is not for resale in any manner.

PUBLICATION ORDERING INFORMATION

LITERATURE FULFILLMENT:
 Literature Distribution Center for ON Semiconductor
 P.O. Box 5163, Denver, Colorado 80217 USA
Phone: 303-675-2175 or 800-344-3860 Toll Free USA/Canada
Fax: 303-675-2176 or 800-344-3867 Toll Free USA/Canada
Email: orderlit@onsemi.com

N. American Technical Support: 800-282-9855 Toll Free
 USA/Canada
Europe, Middle East and Africa Technical Support:
 Phone: 421 33 790 2910
Japan Customer Focus Center
 Phone: 81-3-5773-3850

ON Semiconductor Website: www.onsemi.com

Order Literature: <http://www.onsemi.com/orderlit>

For additional information, please contact your local Sales Representative