



## U74HC2G02

CMOS IC

### 2-INPUT NOR GATE

#### DESCRIPTION

The U74HC2G02 is a 2-input NOR gate which provides the Function  $Y = \overline{A+B}$ .

#### FEATURES

- \* Operation Voltage Range: 2.0~6.0V
- \* Low Power Dissipation:  $I_{CC} = 10\mu A$ (Max)
- \* High Speed:  $t_{pd} = 9ns$ ( $V_{CC} = 4.5V, C_L = 50pF$ )
- \* Specified from -40 to +85 and -40 to +125

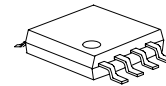

MSOP-8

\*Pb-free plating product number:  
U74HC2G02L

#### ORDERING INFORMATION

Order Number		Package	Packing
Normal	Lead Free Plating		
U74HC2G02-SM1-R	U74HC2G02L-SM1-R	MSOP-8	Tape Reel
U74HC2G02-SM1-T	U74HC2G02L-SM1-T	MSOP-8	Tube

<p>U74HC2G02L-SM1-R</p> <p>(1)Packing Type (2)Package Type (3)Lead Plating</p>	<p>(1) R: Tape Reel, T: Tube (2) SM1: MSOP-8 (3) L: Lead Free Plating, Blank: Pb/Sn</p>
--	---

#### MARKING

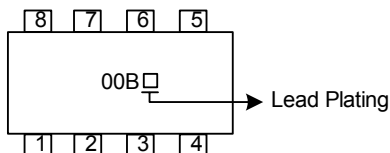

■ PIN CONFIGURATION

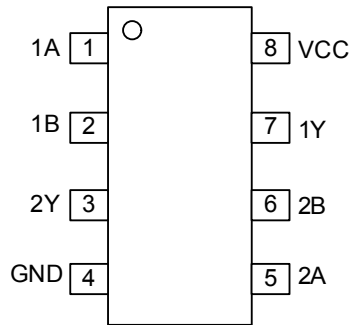

■ FUNCTION TABLE (each gate)

INPUT		OUTPUT
A	B	Y
L	L	H
L	H	L
H	L	L
H	H	L

■ LOGIC DIAGRAM (positive logic)

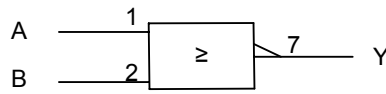
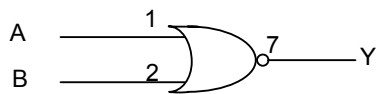

■ ABSOLUTE MAXIMUM RATING (unless otherwise specified)(Note 1)

PARAMETER	SYMBOL	RATINGS	UNIT
Supply Voltage	V <sub>CC</sub>	-0.5~7	V
Input Voltage	V <sub>IN</sub>	-0.5~7	V
Output Voltage	V <sub>OUT</sub>	-0.5~V <sub>CC</sub> +0.5	V
Input Clamp Current	I <sub>IK</sub>	±20	mA
Output Clamp Current	I <sub>OK</sub>	±20	mA
Output Current	I <sub>OUT</sub>	25	mA
V <sub>CC</sub> or GND Current	I <sub>CC</sub>	50	mA
Power dissipation	P <sub>D</sub>	300	mW
Storage Temperature	T <sub>STG</sub>	-65 ~ +150	

Note 1. The input and output voltage ratings may be exceeded if the input and output current ratings are observed.

2. Absolute maximum ratings are those values beyond which the device could be permanently damaged.

Absolute maximum ratings are stress ratings only and functional device operation is not implied.

■ RECOMMENDED OPERATING CONDITIONS

PARAMETER	SYMBOL	CONDITIONS	MIN	TYP	MAX	UNIT
Supply Voltage	V <sub>CC</sub>		2.0	5.0	6.0	V
Input Voltage	V <sub>IN</sub>		0		V <sub>CC</sub>	V
Output Voltage	V <sub>OUT</sub>		0		V <sub>CC</sub>	V
Input Transition Rise or Fall Times	t <sub>r</sub> , t <sub>f</sub>	V <sub>CC</sub> =2.0V			1000	ns
		V <sub>CC</sub> =4.5V		6	500	
		V <sub>CC</sub> =6V			400	
Operating Temperature	T <sub>A</sub>		-40	25	125	

■ STATIC CHARACTERISTICS

PARAMETER	SYMBOL	TEST CONDITIONS	-40~85			-40~125		UNIT
			MIN	TYP	MAX	MIN	MAX	
High-Level Input Voltage	V <sub>IH</sub>	V <sub>CC</sub> =2.0V	1.5	1.2		1.5		V
		V <sub>CC</sub> =4.5V	3.15	2.4		3.15		
		V <sub>CC</sub> =6.0V	4.2	3.2		4.2		
Low-Level Input Voltage	V <sub>IL</sub>	V <sub>CC</sub> =2.0V		0.8	0.5		0.5	V
		V <sub>CC</sub> =4.5V		2.1	1.35		1.35	
		V <sub>CC</sub> =6.0V		2.8	1.8		1.8	
High-Level Output Voltage	V <sub>OH</sub>	V <sub>CC</sub> =2.0V, I <sub>OH</sub> =-20μA	1.9	2.0		1.9		V
		V <sub>CC</sub> =4.5V, I <sub>OH</sub> =-20μA	4.4	4.5		4.4		
		V <sub>CC</sub> =6.0V, I <sub>OH</sub> =-20μA	5.9	6.0		5.9		
		V <sub>CC</sub> =4.5V, I <sub>OH</sub> =-4mA	4.13	4.32		3.7		
		V <sub>CC</sub> =6.0V, I <sub>OH</sub> =-5.2mA	5.63	5.81		5.2		
Low-Level Output Voltage	V <sub>OL</sub>	V <sub>CC</sub> =2.0V, I <sub>OL</sub> =20μA		0	0.1		0.1	V
		V <sub>CC</sub> =4.5V, I <sub>OL</sub> =20μA		0	0.1		0.1	
		V <sub>CC</sub> =6.0V, I <sub>OL</sub> =20μA		0	0.1		0.1	
		V <sub>CC</sub> =4.5V, I <sub>OH</sub> =4mA		0.15	0.33		0.4	
		V <sub>CC</sub> =6.0V, I <sub>OH</sub> =5.2mA		0.16	0.33		0.4	
Input Leakage Current	I <sub>I(LEAK)</sub>	V <sub>CC</sub> =6.0V, V <sub>IN</sub> =V <sub>CC</sub> or GND			±1		±1	μA
Quiescent Supply Current	I <sub>Q</sub>	V <sub>CC</sub> =6.0V, V <sub>IN</sub> =V <sub>CC</sub> or GND, I <sub>OUT</sub> =0			10		20	μA
Input Capacitance	C <sub>IN</sub>	V <sub>CC</sub> =5.0V, V <sub>IN</sub> =V <sub>CC</sub> or GND		1.5				pF

■ DYNAMIC CHARACTERISTICS (Input:  $t_R, t_F \leq 6\text{ns}$ ;  $\text{PRR} \leq 1\text{MHz}$ )

See Fig.1 and Fig.2 for test circuit and waveforms.

PARAMETER	SYMBOL	TEST CONDITIONS	-40~85			-40~125		UNIT
			MIN	TYP	MAX	MIN	MAX	
Propagation Delay from Input (A and B) to Output(Y)	$t_{PHL} / t_{PLH}$	$V_{CC} = 2.0, C_L = 50\text{pF}$		26	95		110	ns
		$V_{CC} = 4.5, C_L = 50\text{pF}$		9	19		22	
		$V_{CC} = 6.0, C_L = 50\text{pF}$		8	16		20	
Output transition Time	$T_{THL} / t_{TLH}$	$V_{CC} = 2.0, C_L = 50\text{pF}$		19	95		125	ns
		$V_{CC} = 4.5, C_L = 50\text{pF}$		7	19		25	
		$V_{CC} = 6.0, C_L = 50\text{pF}$		5	16		20	
<b>Operating Characteristics</b>								
PARAMETER	SYMBOL	TEST CONDITIONS				TYP	UNIT	
Power Dissipation Capacitance	Cpd	No load, $f=1\text{MHz}, V_{CC}=5$				10	pF	

■ TEST CIRCUIT AND WAVEFORMS

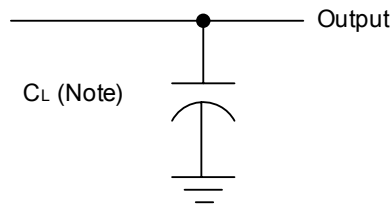

Note: CL includes probe and jig capacitance.

Fig. 1 Load circuitry for switching times.

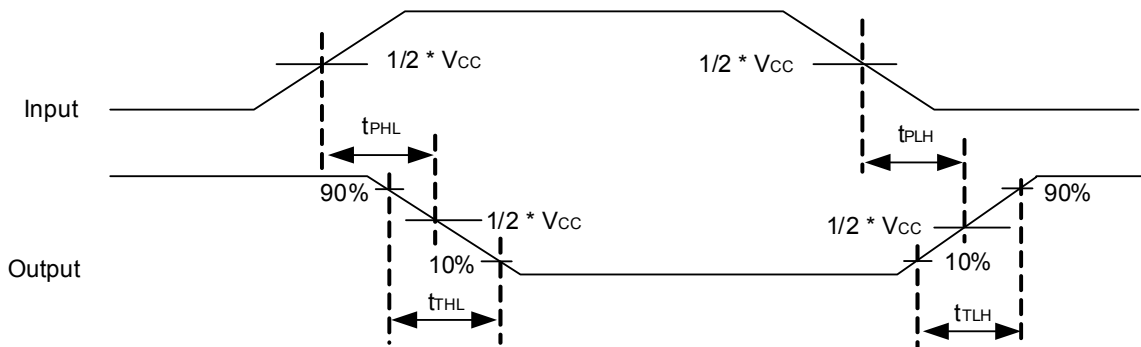

Fig. 2 Propagation delay from input(A and B) to output(Y) and Output transition time.

UTC assumes no responsibility for equipment failures that result from using products at values that exceed, even momentarily, rated values (such as maximum ratings, operating condition ranges, or other parameters) listed in products specifications of any and all UTC products described or contained herein. UTC products are not designed for use in life support appliances, devices or systems where malfunction of these products can be reasonably expected to result in personal injury. Reproduction in whole or in part is prohibited without the prior written consent of the copyright owner. The information presented in this document does not form part of any quotation or contract, is believed to be accurate and reliable and may be changed without notice.