

IRS2112(-1,-2,S)PbF

HIGH AND LOW SIDE DRIVER

Features

- Floating channel designed for bootstrap operation
- Fully operational to +600 V
- Tolerant to negative transient voltage, dV/dt immune
- Gate drive supply range from 10 V to 20 V
- Undervoltage lockout for both channels
- 3.3 V logic compatible
- Separate logic supply range from 3.3 V to 20 V
- Logic and power ground +/- 5 V offset
- CMOS Schmitt-triggered inputs with pull-down
- Cycle by cycle edge-triggered shutdown logic
- Matched propagation delay for both channels
- Outputs in phase with inputs
- RoHS compliant

Description

The IRS2112 is a high voltage, high speed power MOSFET and IGBT driver with independent high- and low-side referenced output channels. Proprietary HVIC and latch immune CMOS technologies enable ruggedized monolithic construction. Logic inputs are compatible with standard CMOS or LSTTL outputs, down to 3.3 V logic. The output drivers feature a high pulse current buffer stage designed for minimum driver cross-conduction. Propagation delays are matched to simplify use in high frequency applications. The floating channel can be used to drive an N-channel power MOSFET or IGBT in the high-side configuration which operates up to 600 V.

Product Summary

V_{OFFSET}	600 V max.
$I_{\text{O}+/-}$	200 mA / 440 mA
V_{OUT}	10 V - 20 V
$t_{\text{on/off}}$ (typ.)	135 ns & 105 ns
Delay Matching	30 ns

Packages

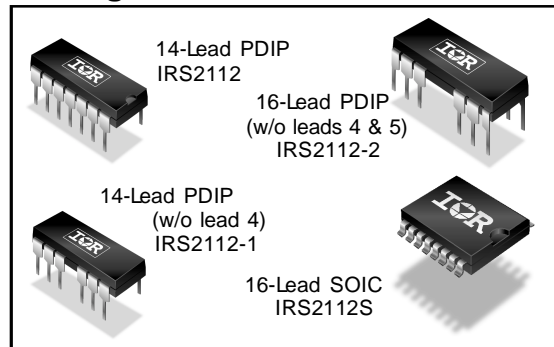

Typical Connection

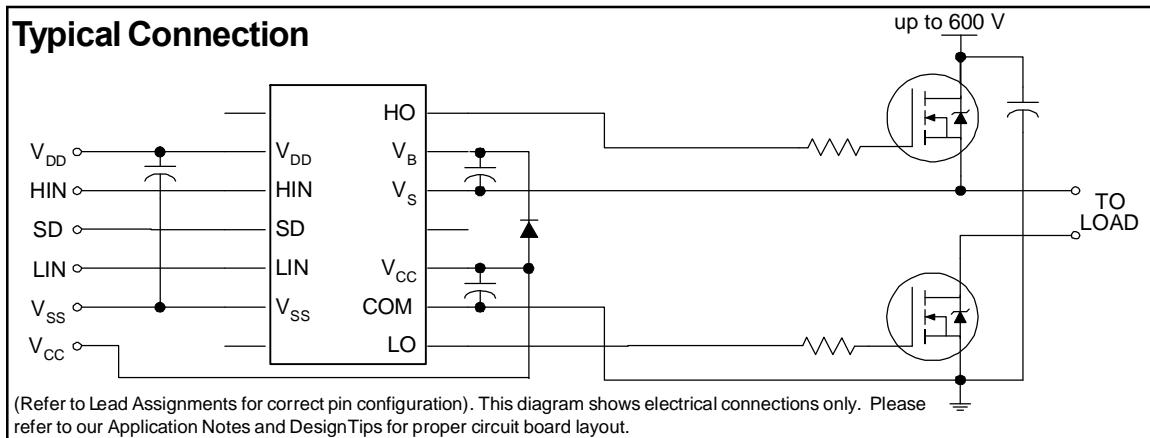

Absolute Maximum Ratings

Absolute maximum ratings indicate sustained limits beyond which damage to the device may occur. All voltage parameters are absolute voltages referenced to COM. The thermal resistance and power dissipation ratings are measured under board mounted and still air conditions. Additional information is shown in Figs. 28 through 35.

Symbol	Definition	Min.	Max.	Units	
V_B	High-side floating supply voltage	-0.3	625	V	
V_S	High-side floating supply offset voltage	$V_B - 25$	$V_B + 0.3$		
V_{HO}	High-side floating output voltage	$V_S - 0.3$	$V_B + 0.3$		
V_{CC}	Low-side fixed supply voltage	-0.3	25		
V_{LO}	Low-side output voltage	-0.3	$V_{CC} + 0.3$		
V_{DD}	Logic supply voltage	-0.3	$V_{SS} + 25$		
V_{SS}	Logic supply offset voltage	$V_{CC} - 25$	$V_{CC} + 0.3$		
V_{IN}	Logic input voltage (HIN, LIN & SD)	$V_{SS} - 0.3$	$V_{DD} + 0.3$		
dV_S/dt	Allowable offset supply voltage transient (Fig. 2)	—	50	V/ns	
P_D	Package power dissipation @ $T_A \leq +25\text{ }^\circ\text{C}$	(14 Lead DIP)	—	1.6	W
		(16 Lead SOIC)	—	1.25	
R_{THJA}	Thermal resistance, junction to ambient	(14 Lead DIP)	—	75	$^\circ\text{C/W}$
		(16 Lead SOIC)	—	100	
T_J	Junction temperature	—	150	$^\circ\text{C}$	
T_S	Storage temperature	-55	150		
T_L	Lead temperature (soldering, 10 seconds)	—	300		

Recommended Operating Conditions

The input/output logic timing diagram is shown in Fig. 1. For proper operation the device should be used within the recommended conditions. The V_S and V_{SS} offset ratings are tested with all supplies biased at 15 V differential. Typical ratings at other bias conditions are shown in Figs. 36 and 37.

Symbol	Definition	Min.	Max.	Units
V_B	High-side floating supply absolute voltage	$V_S + 10$	$V_S + 20$	V
V_S	High-side floating supply offset voltage	Note 1	600	
V_{HO}	High-side floating output voltage	V_S	V_B	
V_{CC}	Low-side fixed supply voltage	10	20	
V_{LO}	Low-side output voltage	0	V_{CC}	
V_{DD}	Logic supply voltage	$V_{SS} + 3$	$V_{SS} + 20$	
V_{SS}	Logic supply offset voltage	-5 (Note 2)	5	
V_{IN}	Logic input voltage (HIN, LIN & SD)	V_{SS}	V_{DD}	
T_A	Ambient temperature	-40	125	$^\circ\text{C}$

Note 1: Logic operational for V_S of -5 V to +600 V. Logic state held for V_S of -5 V to $-V_{BS}$. (Please refer to the Design Tip DT97-3 for more details).

Note 2: When $V_{DD} < 5\text{ V}$, the minimum V_{SS} offset is limited to $-V_{DD}$.

Dynamic Electrical Characteristics

V_{BIAS} (V_{CC} , V_{BS} , V_{DD}) = 15 V, C_L = 1000 pF, T_A = 25 °C and V_{SS} = COM unless otherwise specified. The dynamic electrical characteristics are measured using the test circuit shown in Fig. 3.

Symbol	Definition	Min.	Typ.	Max.	Units	Test Conditions
t_{on}	Turn-on propagation delay	—	135	180	ns	$V_S = 0$ V
t_{off}	Turn-off propagation delay	—	130	160		$V_S = 600$ V
t_{sd}	Shutdown propagation delay	—	130	160		
t_r	Turn-on rise time	—	75	130		
t_f	Turn-off fall time	—	35	65		
MT	Delay matching, HS & LS Turn-on/off	—	—	30		

Static Electrical Characteristics

V_{BIAS} (V_{CC} , V_{BS} , V_{DD}) = 15 V, T_A = 25 °C and V_{SS} = COM unless otherwise specified. The V_{IN} , V_{TH} , and I_{IN} parameters are referenced to V_{SS} and are applicable to all three logic input leads: HIN, LIN, and SD. The V_O and I_O parameters are referenced to COM and are applicable to the respective output leads: HO or LO.

Symbol	Definition	Min.	Typ.	Max.	Units	Test Conditions
V_{IH}	Logic "1" input voltage	9.5	—	—	V	$I_O = 2$ mA
V_{IL}	Logic "0" input voltage	—	—	6.0		
V_{OH}	High level output voltage, $V_{BIAS} - V_O$	—	0.05	0.2		
V_{OL}	Low level output voltage, V_O	—	0.02	0.1		
I_{LK}	Offset supply leakage current	—	—	50	μ A	$V_B = V_S = 600$ V
I_{QBS}	Quiescent V_{BS} supply current	—	25	100		$V_{IN} = 0$ V or V_{DD}
I_{QCC}	Quiescent V_{CC} supply current	—	80	180		$V_{IN} = V_{DD}$
I_{QDD}	Quiescent V_{DD} supply current	—	2.0	30		$V_{IN} = 0$ V
I_{IN+}	Logic "1" input bias current	—	20	40		
I_{IN-}	Logic "0" input bias current	—	—	1.0		
V_{BSUV+}	V_{BS} supply undervoltage positive going threshold	7.4	8.5	9.6	V	
V_{BSUV-}	V_{BS} supply undervoltage negative going threshold	7.0	8.1	9.2		
V_{CCUV+}	V_{CC} supply undervoltage positive going threshold	7.6	8.6	9.6		
V_{CCUV-}	V_{CC} supply undervoltage negative going threshold	7.2	8.2	9.2		
I_{O+}	Output high short circuit pulsed current	200	290	—	mA	$V_O = 0$ V, $V_{IN} = V_{DD}$ $PW \leq 10$ μ s
I_{O-}	Output low short circuit pulsed current	420	600	—		$V_O = 15$ V, $V_{IN} = 0$ V $PW \leq 10$ μ s

Functional Block Diagram

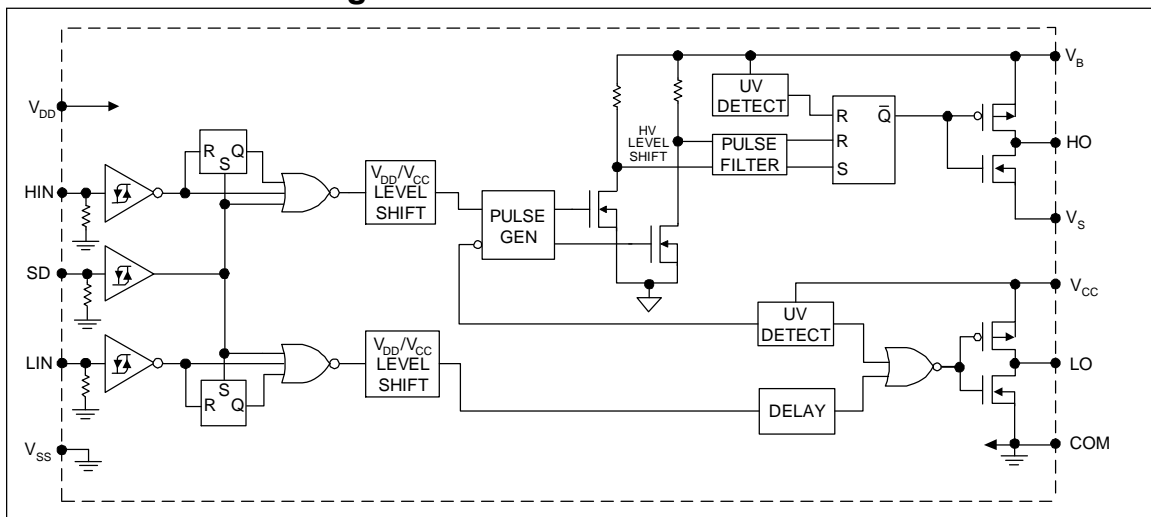

Lead Definitions

Symbol	Description
V _{DD}	Logic supply
HIN	Logic input for high-side gate driver output (HO), in phase
SD	Logic input for shutdown
LIN	Logic input for low-side gate driver output (LO), in phase
V _{SS}	Logic ground
V _B	High-side floating supply
HO	High-side gate drive output
V _S	High-side floating supply return
V _{CC}	Low-side supply
LO	Low-side gate drive output
COM	Low-side return

Lead Assignments

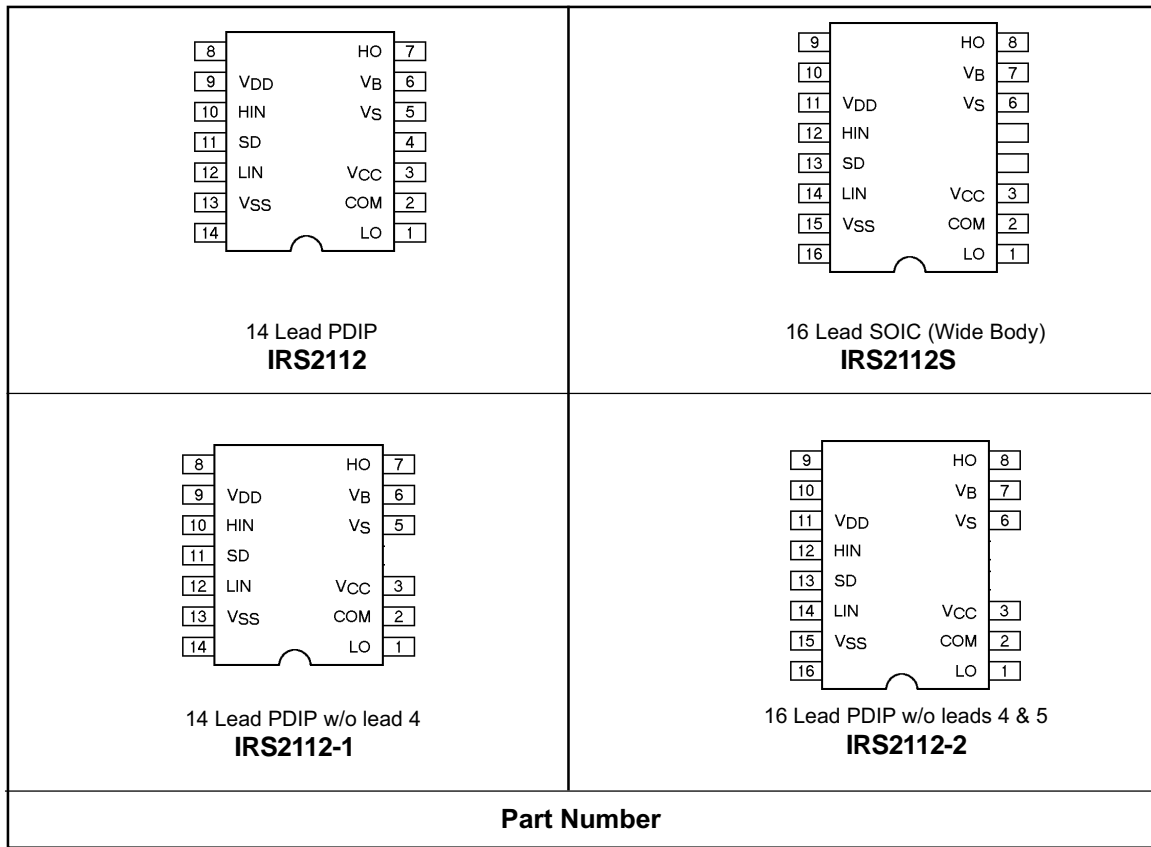

IRS2112(-1,-2,S)PbF

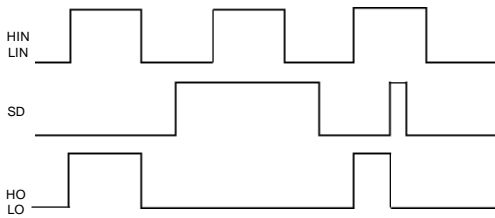

Figure 1. Input/Output Timing Diagram

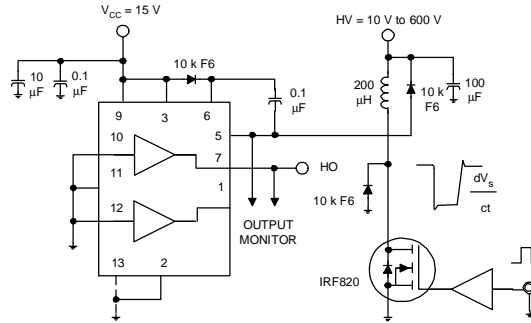

Figure 2. Floating Supply Voltage Transient Test Circuit

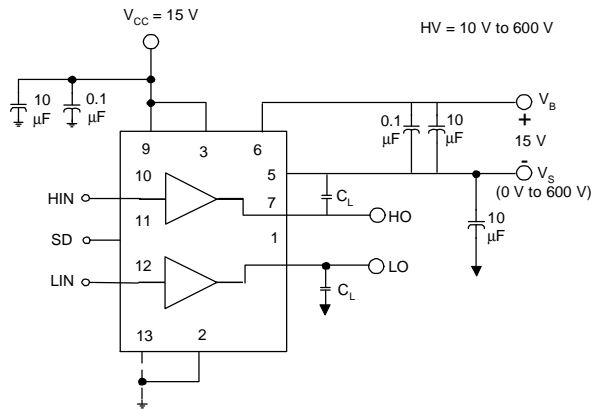

Figure 3. Switching Time Test Circuit

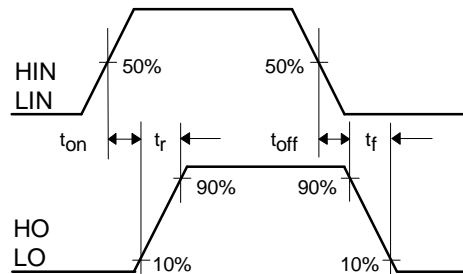

Figure 4. Switching Time Waveform Definition

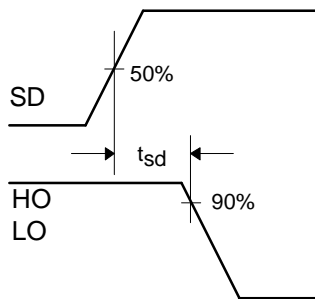

Figure 5. Shutdown Waveform Definitions

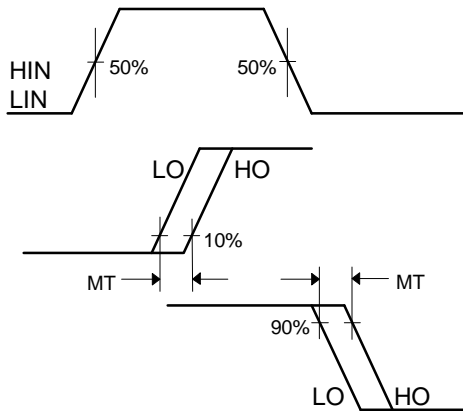

Figure 6. Delay Matching Waveform Definitions

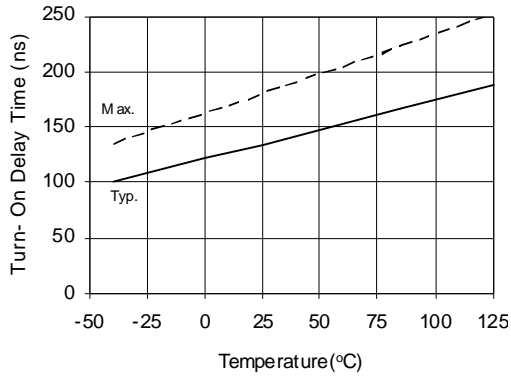

Figure 7A. Turn-On Propagation Delay Time vs. Temperature

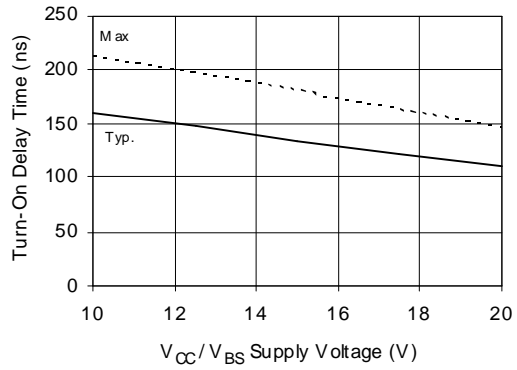

Figure 7B. Turn-On Propagation Delay Time vs. V_{CC}/V_{BS} Supply Voltage

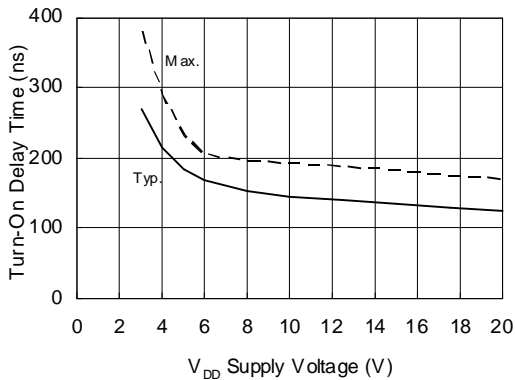

Figure 7C. Turn-On Propagation Delay Time vs. V_{DD} Supply Voltage

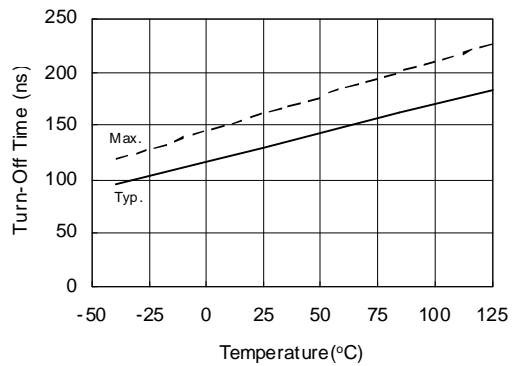

Figure 8A. Turn-Off Propagation Delay Time vs. Temperature

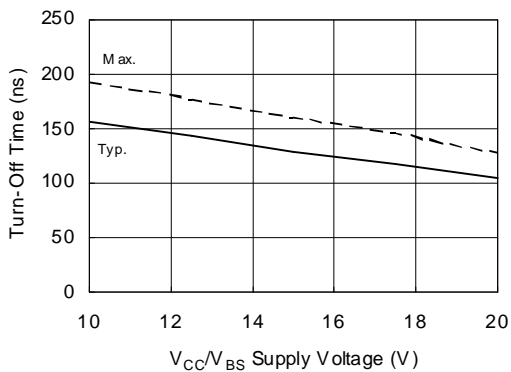

Figure 8B. Turn-Off Propagation Delay Time vs. V_{CC}/V_{BS} Supply Voltage

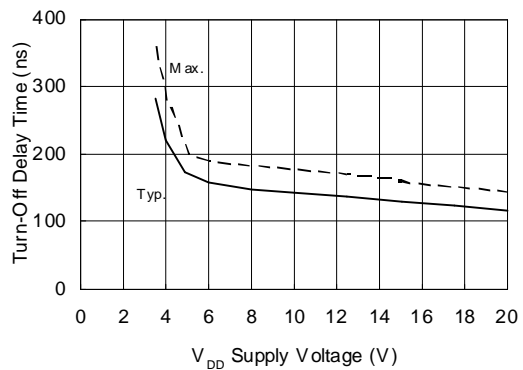

Figure 8C. Turn-Off Propagation Delay Time vs. V_{DD} Supply Voltage

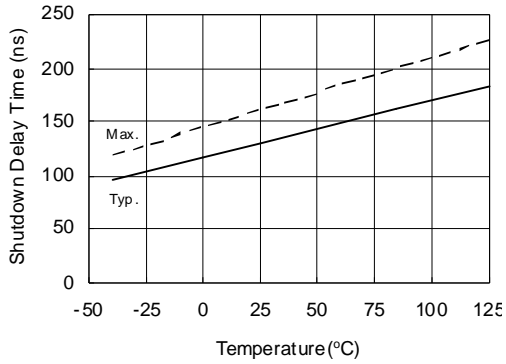

Figure 9A. Shutdown Delay Time vs. Temperature

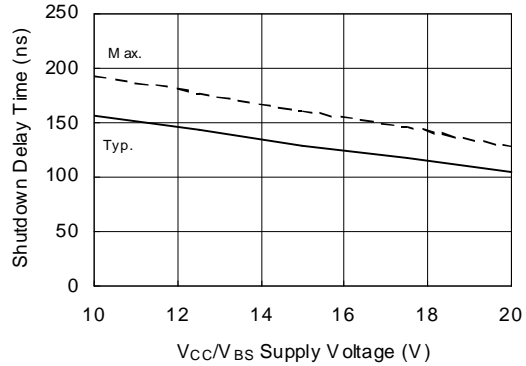

Figure 9B. Shutdown Delay Time vs. V_{CC}/V_{BS} Supply Voltage

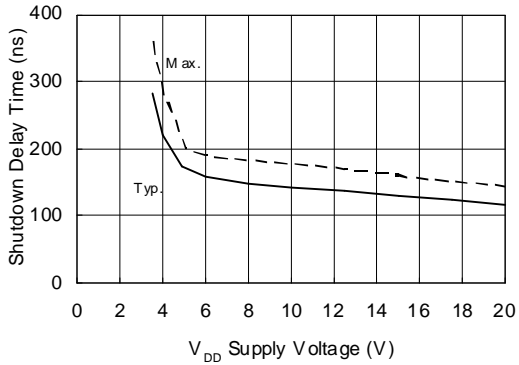

Figure 9C. Shutdown Time vs. V_{DD} Supply Voltage

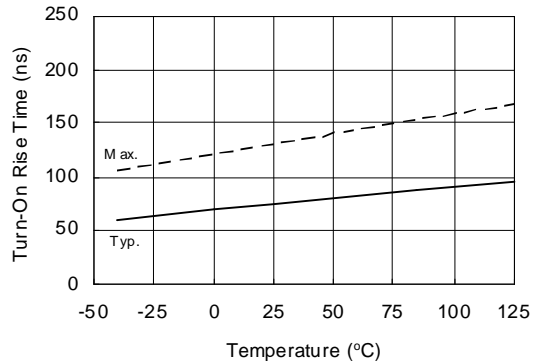

Figure 10A. Turn-On Rise Time vs. Temperature

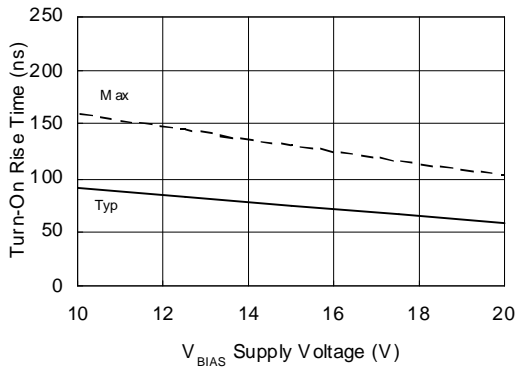

Figure 10B. Turn-On Rise Time vs. Voltage

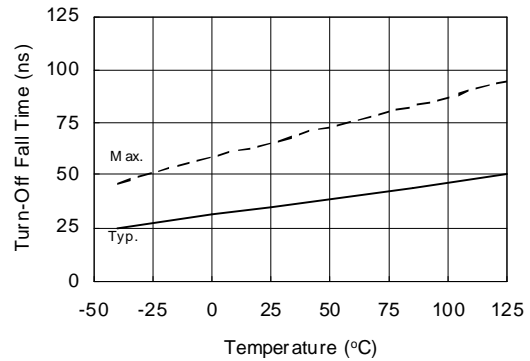

Figure 11A. Turn-Off Fall Time vs. Temperature

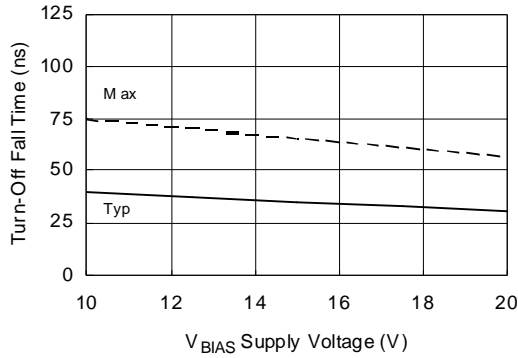

Figure 11B. Turn-Off Fall Time vs. Supply Voltage

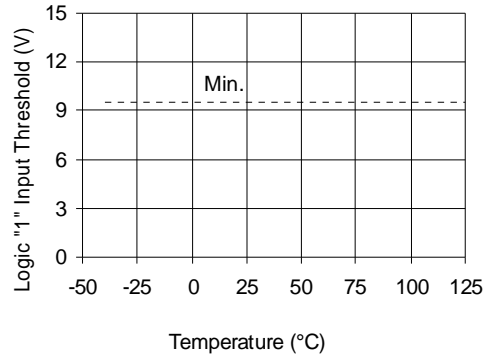

Figure 12A. Logic "1" Input Threshold vs. Temperature

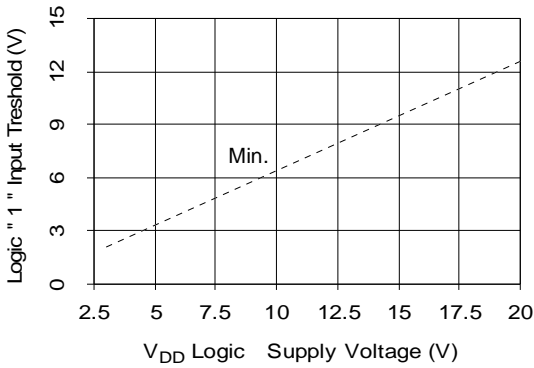

Figure 12B. Logic "1" Input Threshold vs. Voltage

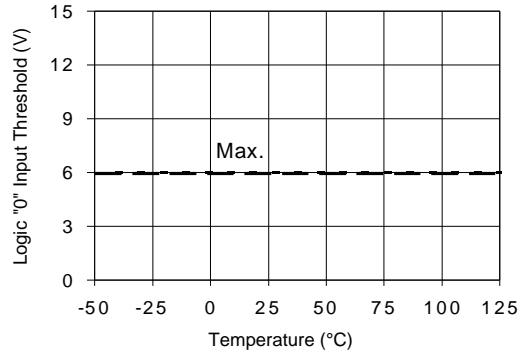

Figure 13A. Logic "0" Input Threshold vs. Temperature

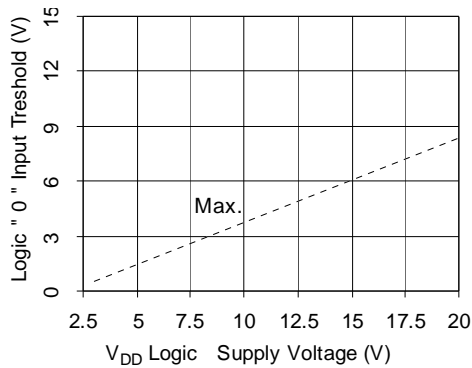

Figure 13B. Logic "0" Input Threshold vs. Voltage

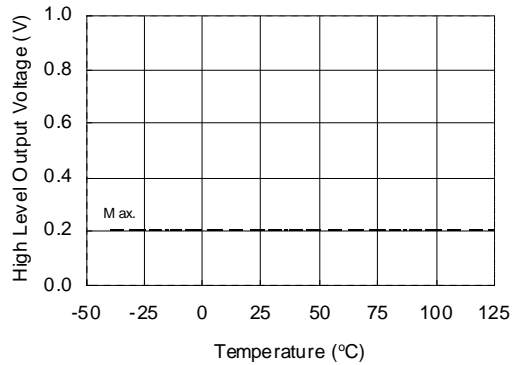

Figure 14A. High Level Output Voltage vs. Temperature (I_O = 2 mA)

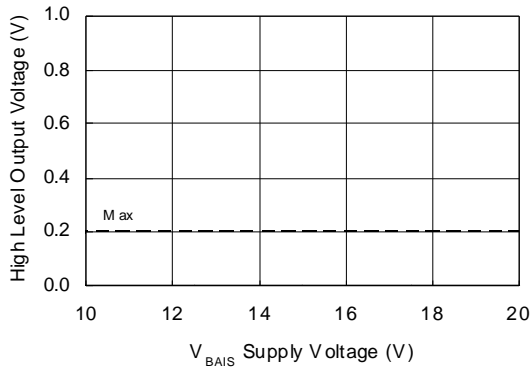

Figure 14B. High Level Output Voltage vs. Supply Voltage ($I_o = 2 \text{ mA}$)

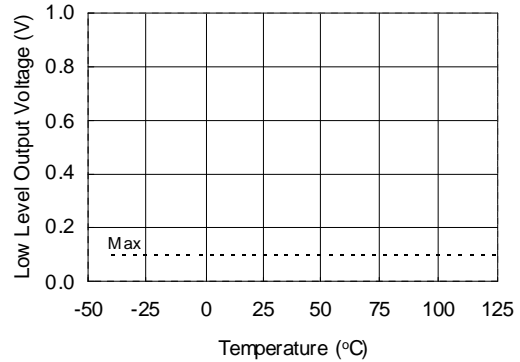

Figure 15A. Low Level Output Voltage vs. Temperature ($I_o = 2 \text{ mA}$)

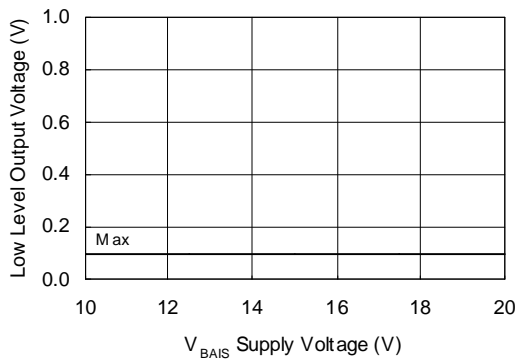

Figure 15B. Low Level Output Voltage vs. Supply Voltage ($I_o = 2 \text{ mA}$)

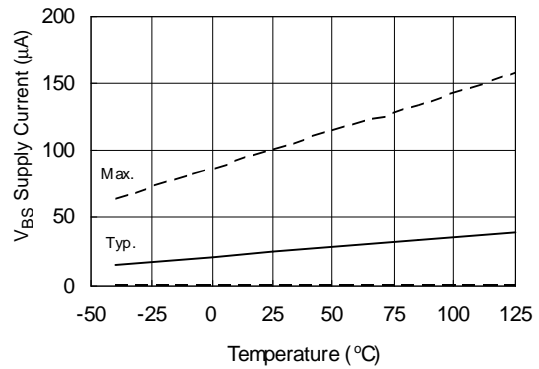

Figure 16A. V_{BS} Supply Current vs. Temperature

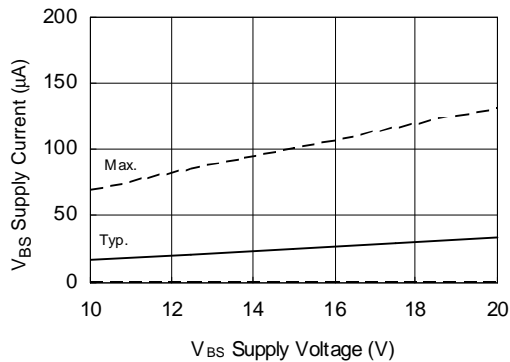

Figure 16B. V_{BS} Supply Current vs. Voltage

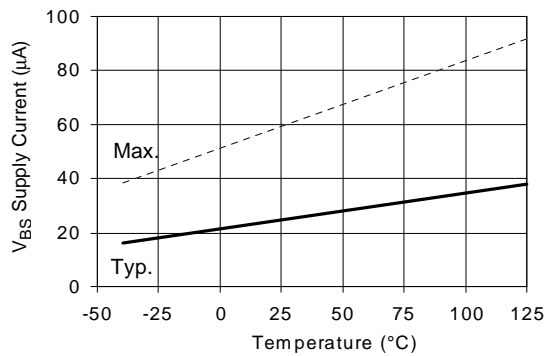

Figure 17A. V_{BS} Supply Current vs. Temperature

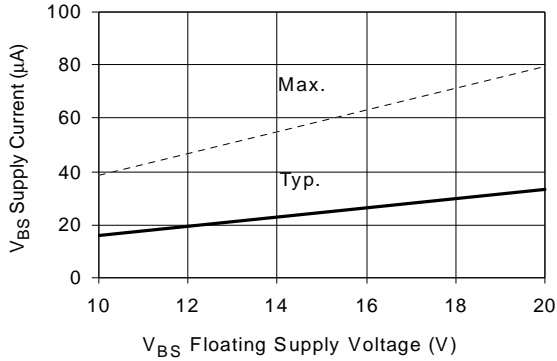

Figure 17B. V_{BS} Supply Current vs. Voltage

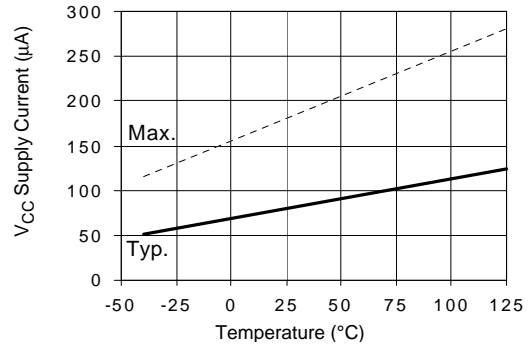

Figure 18A. V_{CC} Supply Current vs. Temperature

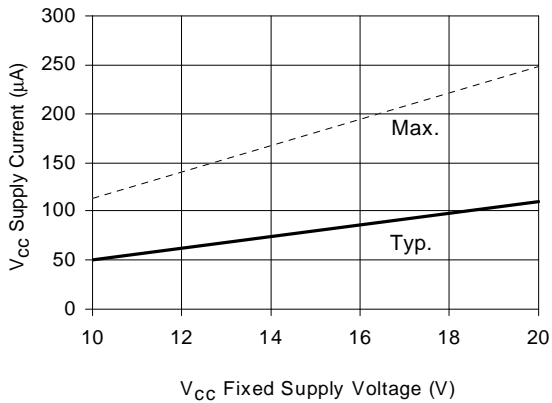

Figure 18B. V_{CC} Supply Current vs. Voltage

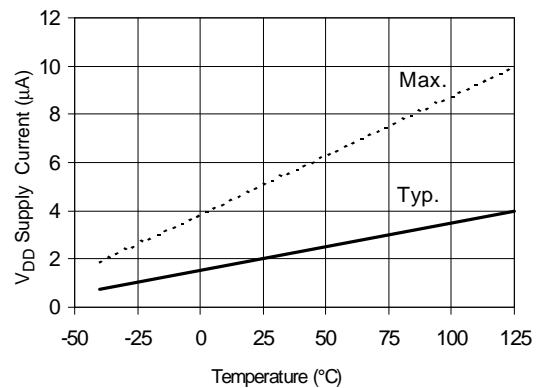

Figure 19A. V_{DD} Supply Current vs. Temperature

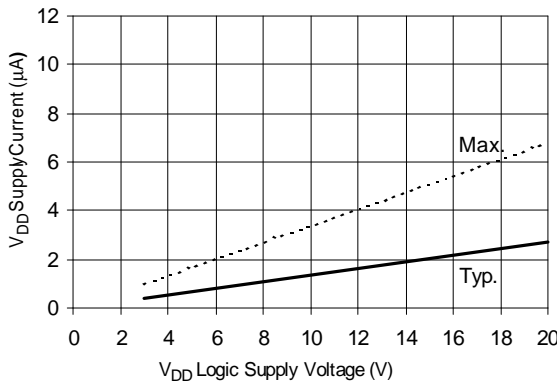

Figure 19B. V_{DD} Supply Current vs. V_{DD} Voltage

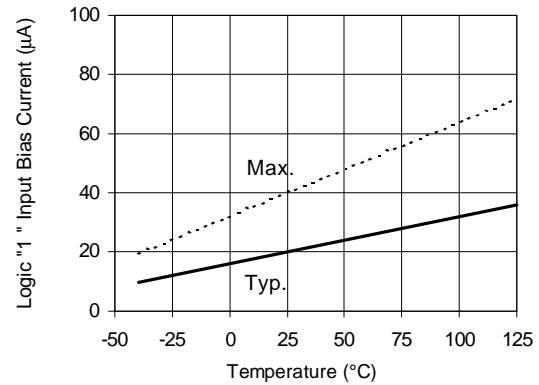

Figure 20A. Logic "1" Input Current vs. Temperature

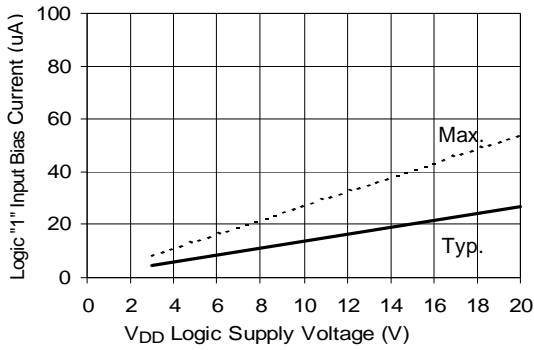

Figure 20B. Logic "1" Input Current vs. V_{DD} Voltage

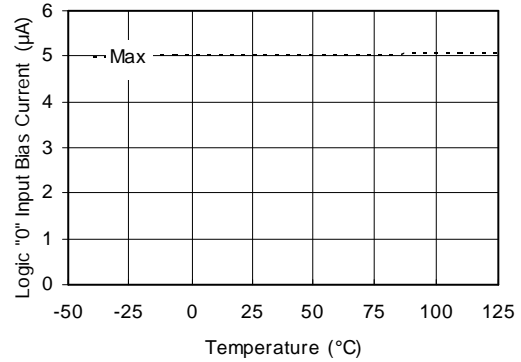

Figure 21A. Logic "0" Input Bias Current vs. Temperature

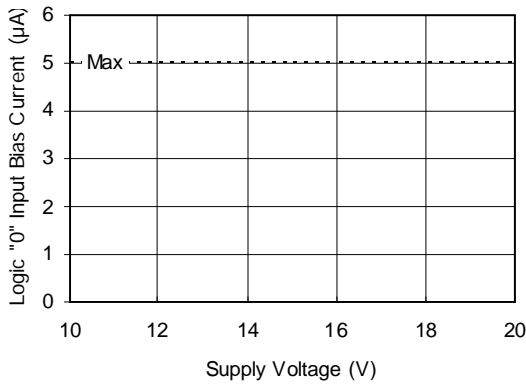

Figure 21B. Logic "0" Input Bias Current vs. Voltage

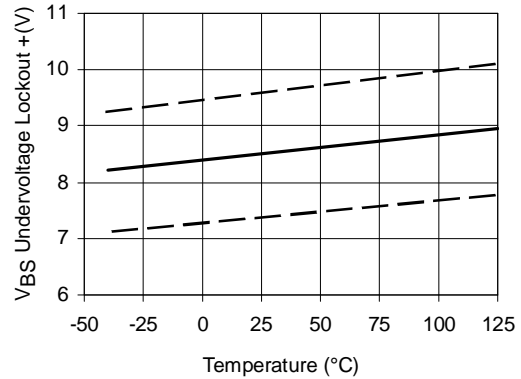

Figure 22. V_{BS} Undervoltage (+) vs. Temperature

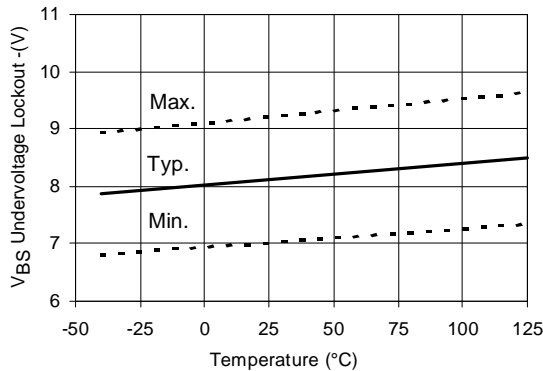

Figure 23. V_{BS} Undervoltage (-) vs. Temperature

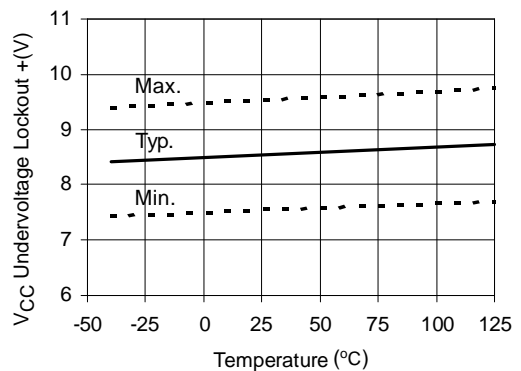

Figure 24. V_{CC} Undervoltage (-) vs. Temperature

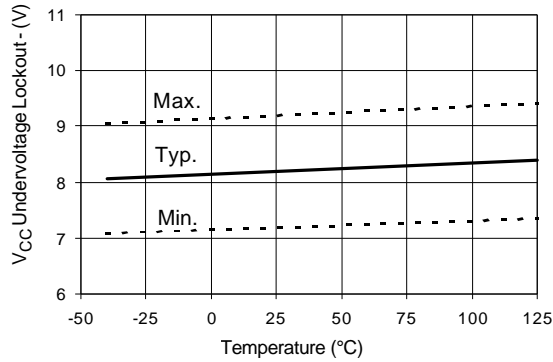

Figure 25. V_{CC} Undervoltage (-) vs. Temperature

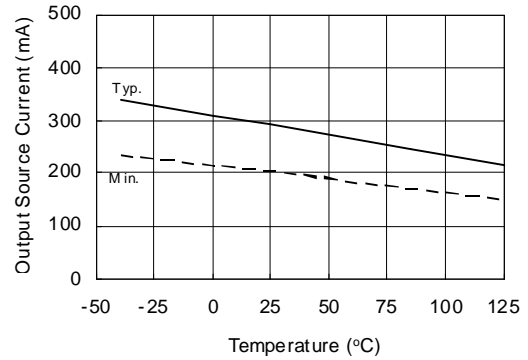

Figure 26A. Output Source Current vs. Temperature

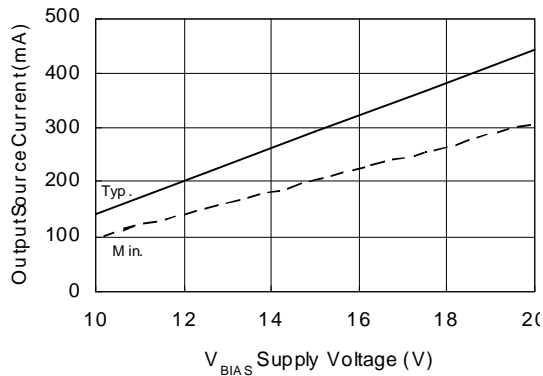

Figure 26B. Output Source Current vs. Supply Voltage

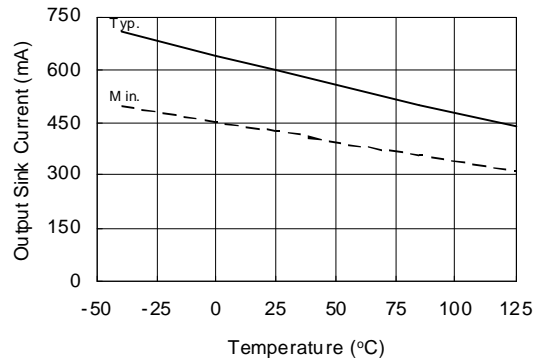

Figure 27A. Output Sink Current vs. Temperature

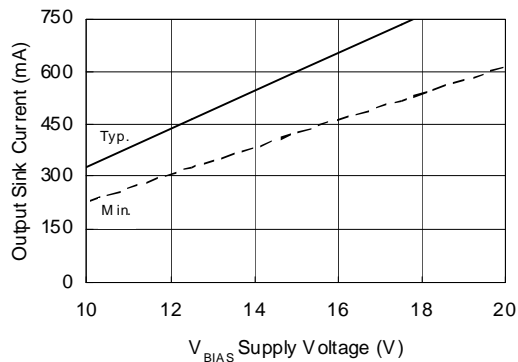

Figure 27B. Output Sink Current vs. Supply Voltage

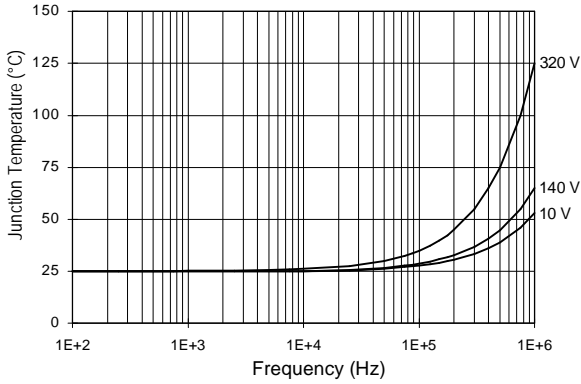

Figure 28. IRS2112 T_J vs. Frequency (IRFBC20)
R_{GATE} = 33 W, V_{CC} = 15 V

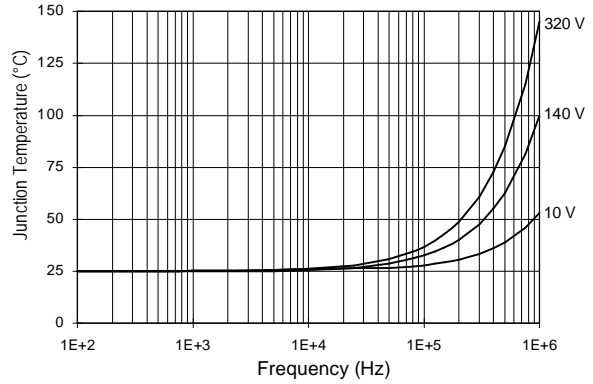

Figure 29. IRS2112 T_J vs. Frequency (IRFBC30)
R_{GATE} = 22 W, V_{CC} = 15 V

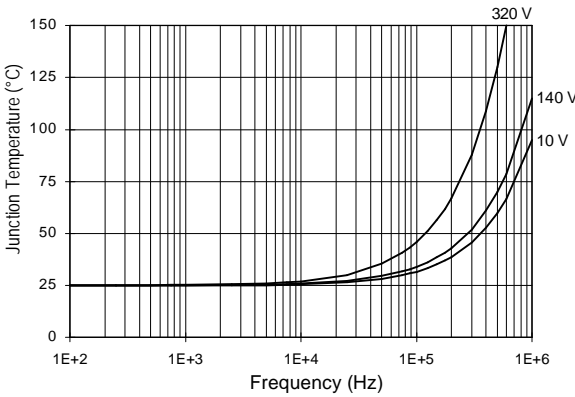

Figure 30. IRS2112 T_J vs. Frequency (IRFBC40)
R_{GATE} = 15 W, V_{CC} = 15 V

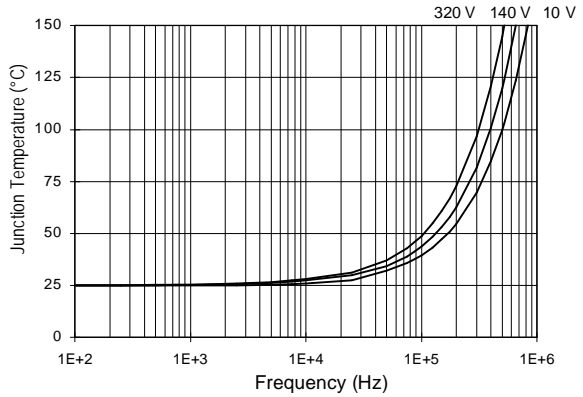

Figure 31. IRS2112 T_J vs. Frequency (IRFPE50)
R_{GATE} = 10 W, V_{CC} = 15 V

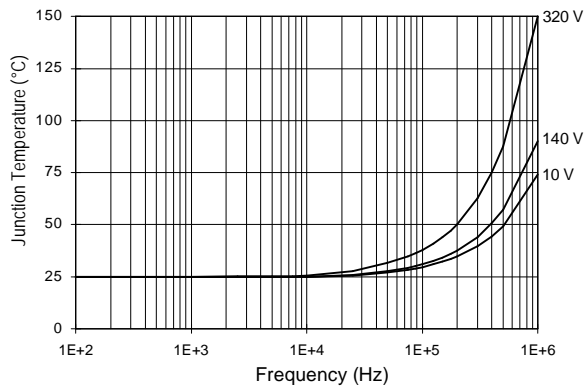

Figure 32. IRS2112S T_J vs. Frequency (IRFBC20)
R_{GATE} = 33 W, V_{CC} = 15 V

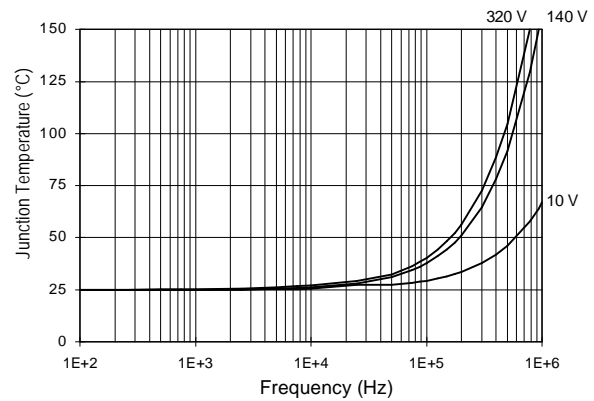

Figure 33. IRS2112S T_J vs. Frequency (IRFBC30)
R_{GATE} = 22 W, V_{CC} = 15 V

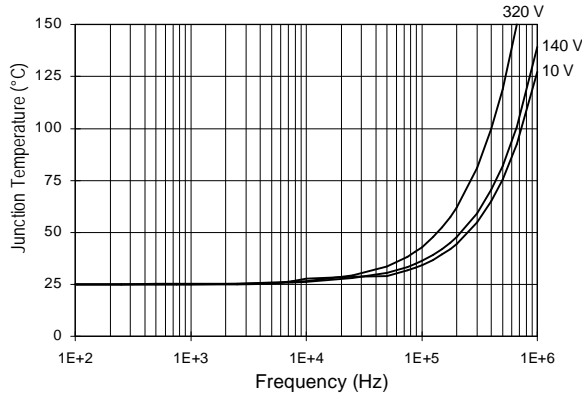

Figure 34. IRS2112S T_J vs. Frequency (IRFBC40)
 $R_{GATE} = 15 W, V_{CC} = 15 V$

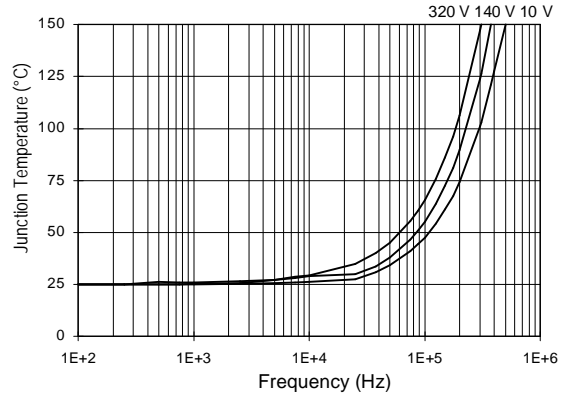

Figure 35. IRS2112S T_J vs. Frequency (IRFPE50)
 $R_{GATE} = 10 W, V_{CC} = 15 V$

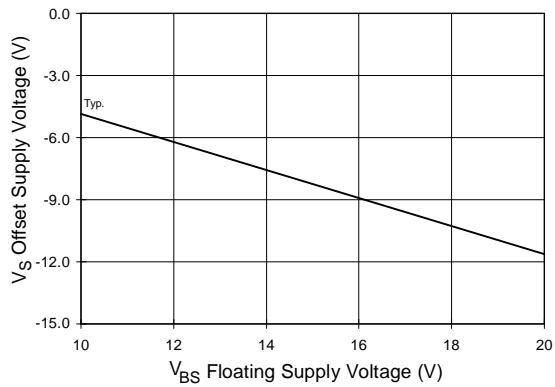

Figure 36. Maximum V_S Negative Offset vs. V_{BS} Supply Voltage

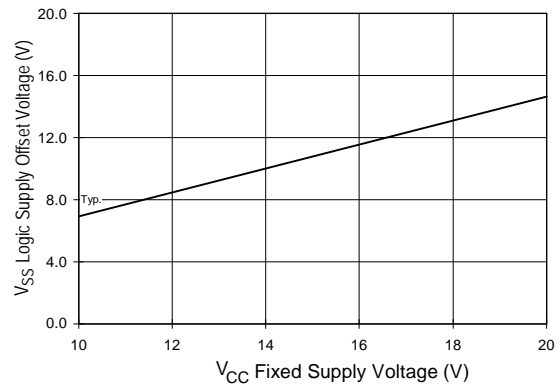
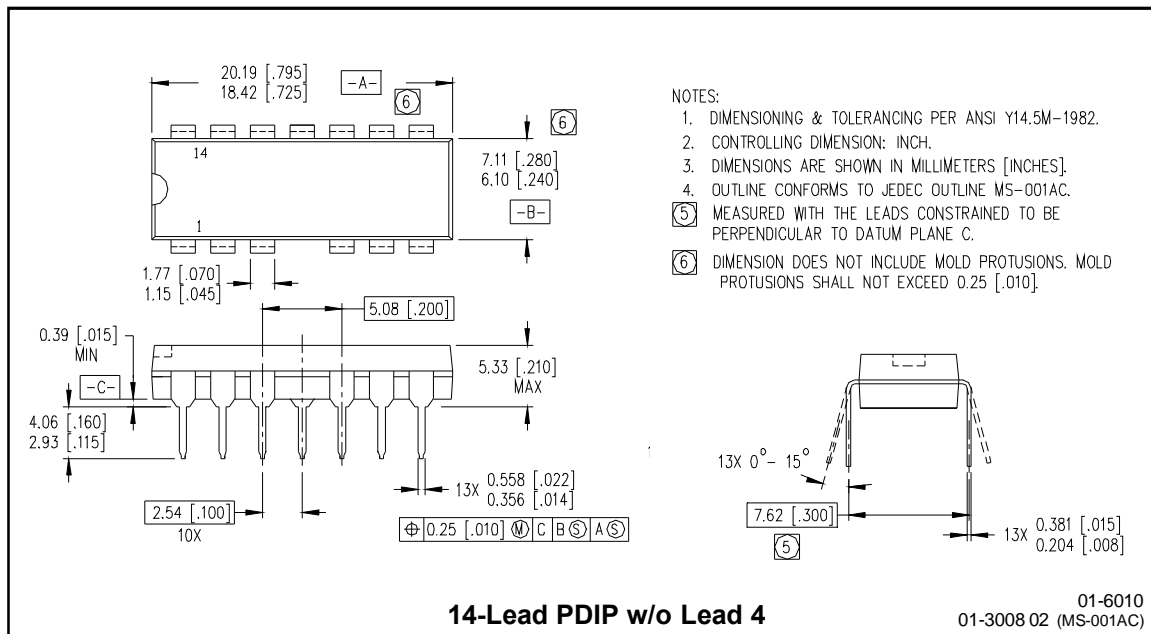
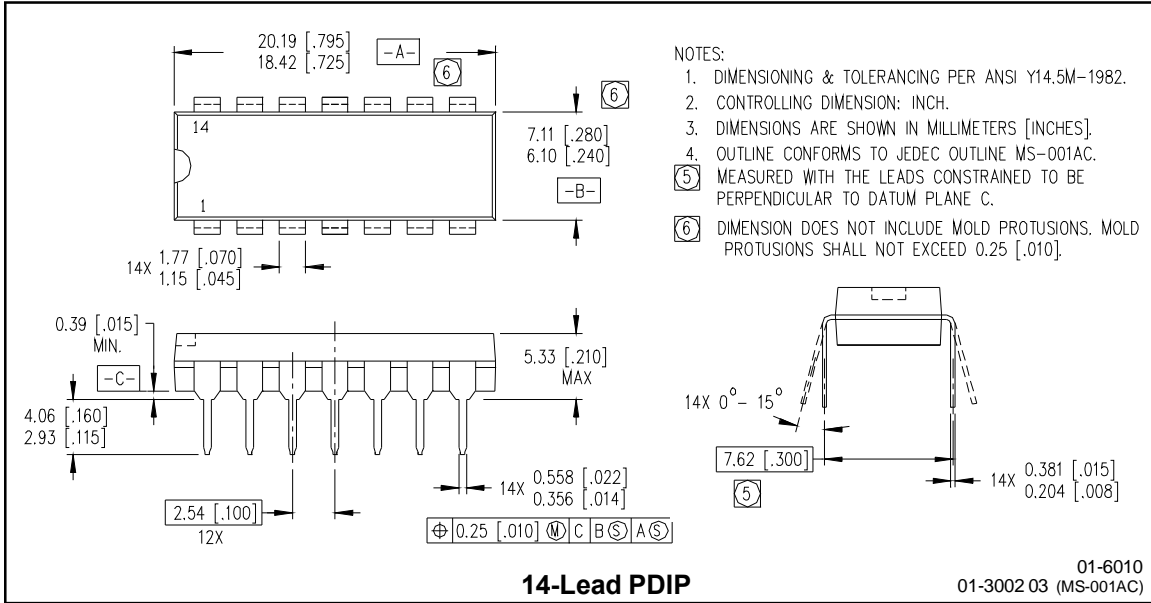
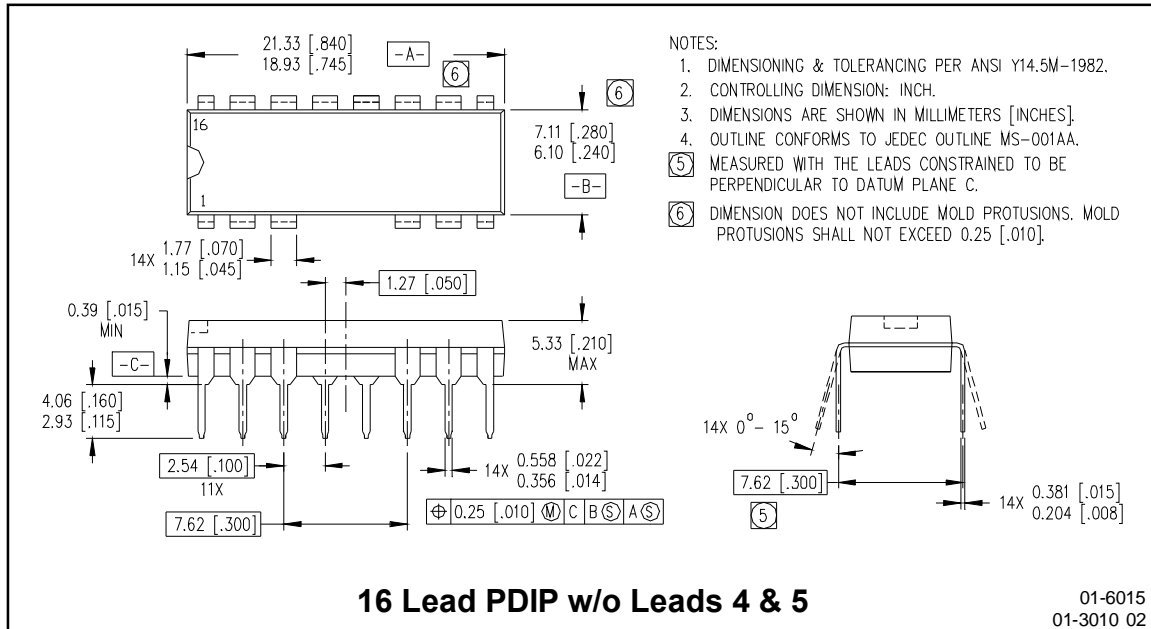

Figure 37. Maximum V_{SS} Positive Offset vs. V_{CC} Supply Voltage

Case outline





NOTES:

1. DIMENSIONING & TOLERANCING PER ANSI Y14.5M-1982.
2. CONTROLLING DIMENSION: INCH.
3. DIMENSIONS ARE SHOWN IN MILLIMETERS [INCHES].
4. OUTLINE CONFORMS TO JEDEC OUTLINE MS-001AA.
5. MEASURED WITH THE LEADS CONSTRAINED TO BE PERPENDICULAR TO DATUM PLANE C.
6. DIMENSION DOES NOT INCLUDE MOLD PROTUSIONS. MOLD PROTUSIONS SHALL NOT EXCEED 0.25 [.010].

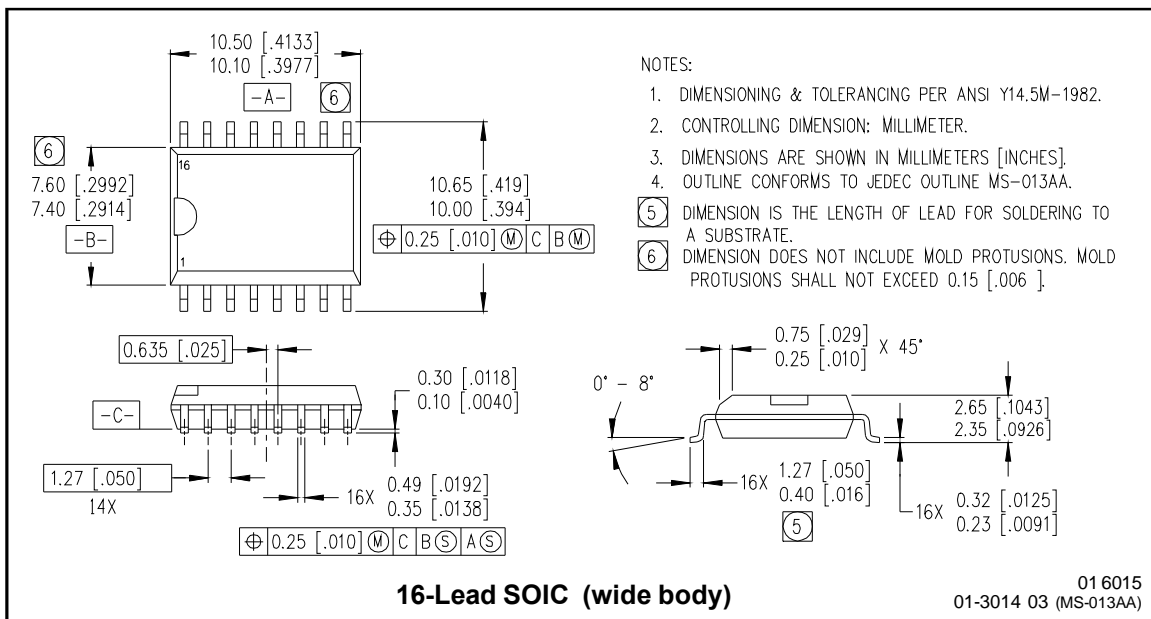

NOTES:

1. DIMENSIONING & TOLERANCING PER ANSI Y14.5M-1982.
2. CONTROLLING DIMENSION: MILLIMETER.
3. DIMENSIONS ARE SHOWN IN MILLIMETERS [INCHES].
4. OUTLINE CONFORMS TO JEDEC OUTLINE MS-013AA.
5. DIMENSION IS THE LENGTH OF LEAD FOR SOLDERING TO A SUBSTRATE.
6. DIMENSION DOES NOT INCLUDE MOLD PROTUSIONS. MOLD PROTUSIONS SHALL NOT EXCEED 0.15 [.006].

Tape & Reel 16-Lead SOIC

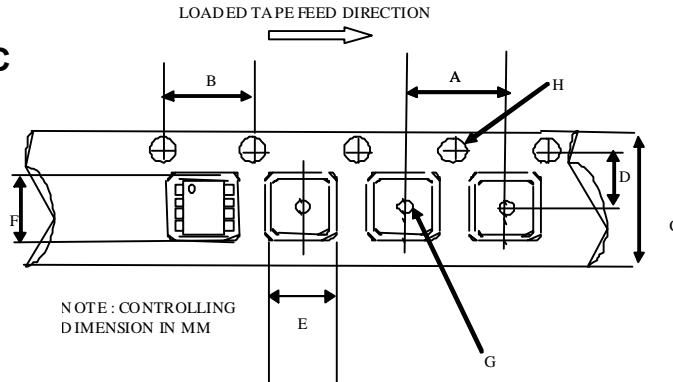

CARRIER TAPE DIMENSION FOR 16SOICW

Code	Metric		Imperial	
	Min	Max	Min	Max
A	11.90	12.10	0.468	0.476
B	3.90	4.10	0.153	0.161
C	15.70	16.30	0.618	0.641
D	7.40	7.60	0.291	0.299
E	10.80	11.00	0.425	0.433
F	10.60	10.80	0.417	0.425
G	1.50	n/a	0.059	n/a
H	1.50	1.60	0.059	0.062

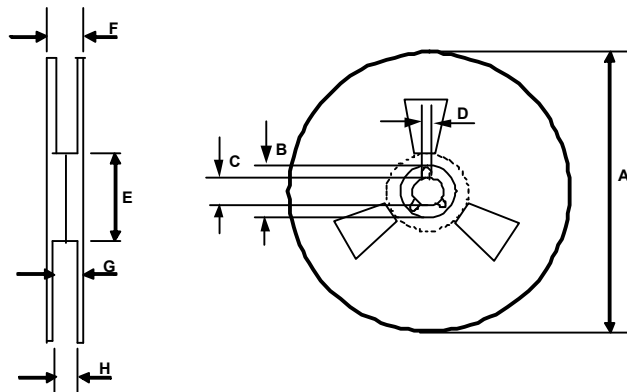

REEL DIMENSIONS FOR 16SOICW

Code	Metric		Imperial	
	Min	Max	Min	Max
A	329.60	330.25	12.976	13.001
B	20.95	21.45	0.824	0.844
C	12.80	13.20	0.503	0.519
D	1.95	2.45	0.767	0.096
E	98.00	102.00	3.858	4.015
F	n/a	22.40	n/a	0.881
G	18.50	21.10	0.728	0.830
H	16.40	18.40	0.645	0.724

LEADFREE PART MARKING INFORMATION

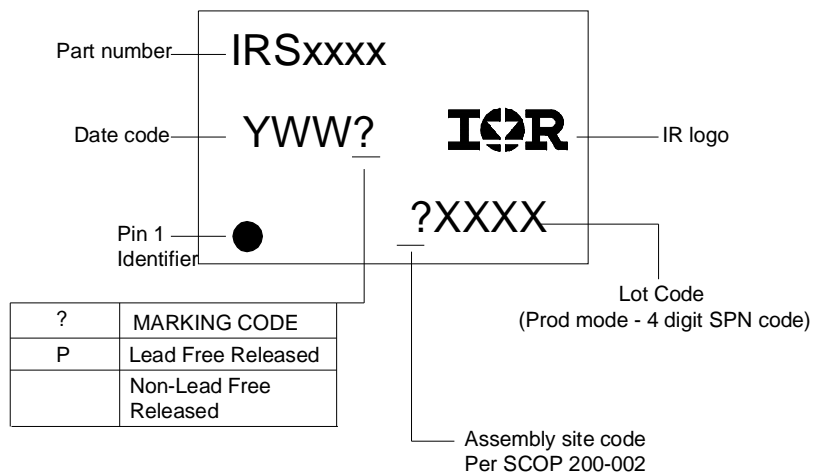

ORDER INFORMATION

- 14-Lead PDIP IRS2112PbF
- 14-Lead PDIP IRS2112-1PbF
- 16-Lead PDIP IRS2112-2PbF
- 16-Lead SOIC IRS2112SPbF
- 16-Lead SOIC Tape & Reel IRS2112STRPbF