



# 4-Channel S-Video, CVBS Video Filter with Asynchronous CVBS Input

MAX7447

## General Description

The MAX7447 4-channel, buffered video reconstruction filter is ideal for anti-aliasing and DAC-smoothing video applications or wherever analog video is reconstructed from a digital data stream (such as cable/satellite/terrestrial set-top boxes, DVD players, hard disk recorders (HDRs), and personal video recorders (PVRs)). This device operates from a single +5V supply and has a flat passband out to 5MHz with a stopband attenuation of 43dB at 27MHz. This makes it ideal for use with NTSC, PAL, and standard-definition digital TV (SDTV) video systems. Each output is capable of driving two standard 150Ω video loads.

The MAX7447 processes S-Video and CVBS video signals. The video output buffers have a fixed gain of +6dB. Each channel has high-frequency boost circuitry that provides picture sharpness with up to +1.2dB of gain boost without degradation in the stopband. The output video drivers can be disabled with an external pin.

The MAX7447 is available in a 14-pin TSSOP package with an exposed pad, and is specified over the -40°C to +85°C extended temperature range.

## Applications

- Set-Top Boxes/HDRs
- Game Consoles
- Desktop Video Editors
- DVD Players
- Digital VCRs

## Features

- ◆ 4-Channel Filter and Buffer for S-Video and CVBS Signals
- ◆ Filter Response Ideal for NTSC, PAL, and Interlaced SDTV Video Signals
- ◆ 43dB (typ) Stopband Attenuation at 27MHz
- ◆ ±0.75dB (max) Passband Ripple Out to 5MHz
- ◆ Blanking Level Voltage on Output <1V
- ◆ Each Channel Drives Two 150Ω Video Loads
- ◆ +5V Single-Supply Voltage
- ◆ Small 14-Pin TSSOP Package

## Ordering Information

PART	TEMP RANGE	PIN-PACKAGE
MAX7447EUD	-40°C to +85°C	14 TSSOP-EP*

\*EP = Exposed pad.

## Functional Diagram

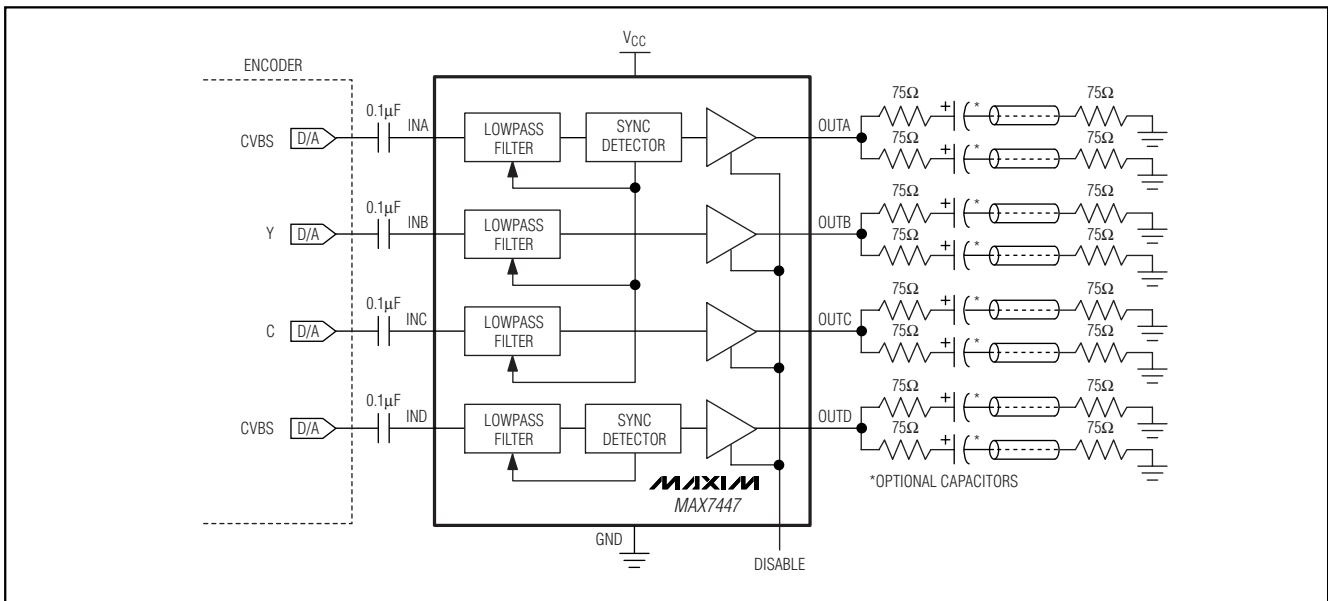

Pin Configuration appears at end of data sheet.



**For pricing, delivery, and ordering information, please contact Maxim/Dallas Direct! at 1-888-629-4642, or visit Maxim's website at [www.maxim-ic.com](http://www.maxim-ic.com).**

# 4-Channel S-Video, CVBS Video Filter with Asynchronous CVBS Input

## ABSOLUTE MAXIMUM RATINGS

V<sub>CC</sub> to GND .....+6V  
 All Other Pins to GND.....-0.3V to (V<sub>CC</sub> + 0.3V)  
 Maximum Current into Any Pin Except V<sub>CC</sub> and GND .....±50mA  
 Continuous Power Dissipation (T<sub>A</sub> = +70°C)  
   TSSOP-EP (derate 20.8mW/°C above +70°C).....1667mW

Operating Temperature Range .....-40°C to +85°C  
 Storage Temperature Range .....-65°C to +150°C  
 Junction Temperature .....+150°C  
 Lead Temperature (soldering, 10s) .....+300°C

Stresses beyond those listed under "Absolute Maximum Ratings" may cause permanent damage to the device. These are stress ratings only, and functional operation of the device at these or any other conditions beyond those indicated in the operational sections of the specifications is not implied. Exposure to absolute maximum rating conditions for extended periods may affect device reliability.

## ELECTRICAL CHARACTERISTICS

(V<sub>CC</sub> = +5V ±5%, C<sub>L</sub> = 0 to 20pF, R<sub>L</sub> = 75Ω to GND for DC-coupled load, R<sub>L</sub> = 75Ω to V<sub>CC</sub> / 2 for AC-coupled load, C<sub>IN</sub> = 0.1μF, T<sub>A</sub> = T<sub>MIN</sub> to T<sub>MAX</sub>, unless otherwise noted. Typical values are at V<sub>CC</sub> = +5V, T<sub>A</sub> = +25°C.)

PARAMETER	SYMBOL	CONDITIONS	MIN	TYP	MAX	UNITS
Passband Response		f = 100kHz to 5MHz, relative to 100kHz	0.9	1.2	1.5	dB
Stopband Attenuation	A <sub>SB</sub>	f ≥ 27MHz	39	43		dB
Differential Gain	dG	5-step modulated staircase		0.15	0.50	%
Differential Phase	dθ	5-step modulated staircase		0.15	0.50	Degrees
Signal-to-Noise Ratio	SNR	Peak signal (2V <sub>P-P</sub> ) to RMS noise, f = 100Hz to 50MHz		80		dB
Group Delay Deviation	Δt <sub>g</sub>	Deviation from 100kHz to 4.1MHz		17	30	ns
Line-Time Distortion	H <sub>DIST</sub>	18μs, 100 IRE bar			0.3	%
Field-Time Distortion	V <sub>DIST</sub>	130 lines, 18μs, 100 IRE bar			0.5	%
Clamp Settling Time	t <sub>CLAMP</sub>	To ±1%			100	Lines
Output DC Clamp Level		Channel A, B, D	0.6	0.9	1.1	V
		Channel C	1.25	1.60	1.95	
Low-Frequency Gain Accuracy	A <sub>V</sub>	f = 100kHz, relative to a gain of +6dB	-3		+3	%
Low-Frequency Gain Matching	A <sub>V(MATCH)</sub>	Low-frequency channel-to-channel matching, f = 100kHz			4	%
Group Delay Matching	t <sub>g(MATCH)</sub>	Low-frequency channel-to-channel matching, f = 100kHz		2		ns
Channel-to-Channel Crosstalk	X <sub>TALK</sub>	f = 100kHz to 3.58MHz		60		dB
Output Short-Circuit Current	I <sub>SC</sub>	OUT_ shorted to GND or V <sub>CC</sub>		70		mA
Input Leakage Current	I <sub>IN</sub>				10	μA
Input Dynamic Swing		Channel A, B, D			1.2	V <sub>P-P</sub>
		Channel C			0.9	
<b>SUPPLY</b>						
Supply Voltage Range	V <sub>CC</sub>		4.75		5.25	V
Supply Current	I <sub>CC</sub>	No load		100	140	mA
Power-Supply Rejection Ratio	PSRR	V <sub>IN</sub> = 100mV <sub>P-P</sub> , f = 0 to 3.5MHz		40		dB

# 4-Channel S-Video, CVBS Video Filter with Asynchronous CVBS Input

## ELECTRICAL CHARACTERISTICS (continued)

( $V_{CC} = +5V \pm 5\%$ ,  $C_L = 0$  to  $20pF$ ,  $R_L = 75\Omega$  to GND for DC-coupled load,  $R_L = 75\Omega$  to  $V_{CC} / 2$  for AC-coupled load,  $C_{IN\_} = 0.1\mu F$ ,  $T_A = T_{MIN}$  to  $T_{MAX}$ , unless otherwise noted. Typical values are at  $V_{CC} = +5V$ ,  $T_A = +25^\circ C$ .)

PARAMETER	SYMBOL	CONDITIONS	MIN	TYP	MAX	UNITS
<b>DISABLE</b>						
Output Impedance During Disable	$Z_{DISABLE}$	At 5MHz		2		$k\Omega$
Disable Logic-Input High Voltage	$V_{IH}$		2.0			V
Disable Logic-Input Low Voltage	$V_{IL}$				0.8	V
Disable Logic-Input Current	$I_{DISABLE}$	$V_{IL} = 0V$ (sink), $V_{IH} = V_{CC}$ (source)			$\pm 10$	$\mu A$

## Typical Operating Characteristics

( $V_{CC} = +5V$ ,  $T_A = +25^\circ C$ , unless otherwise noted.)

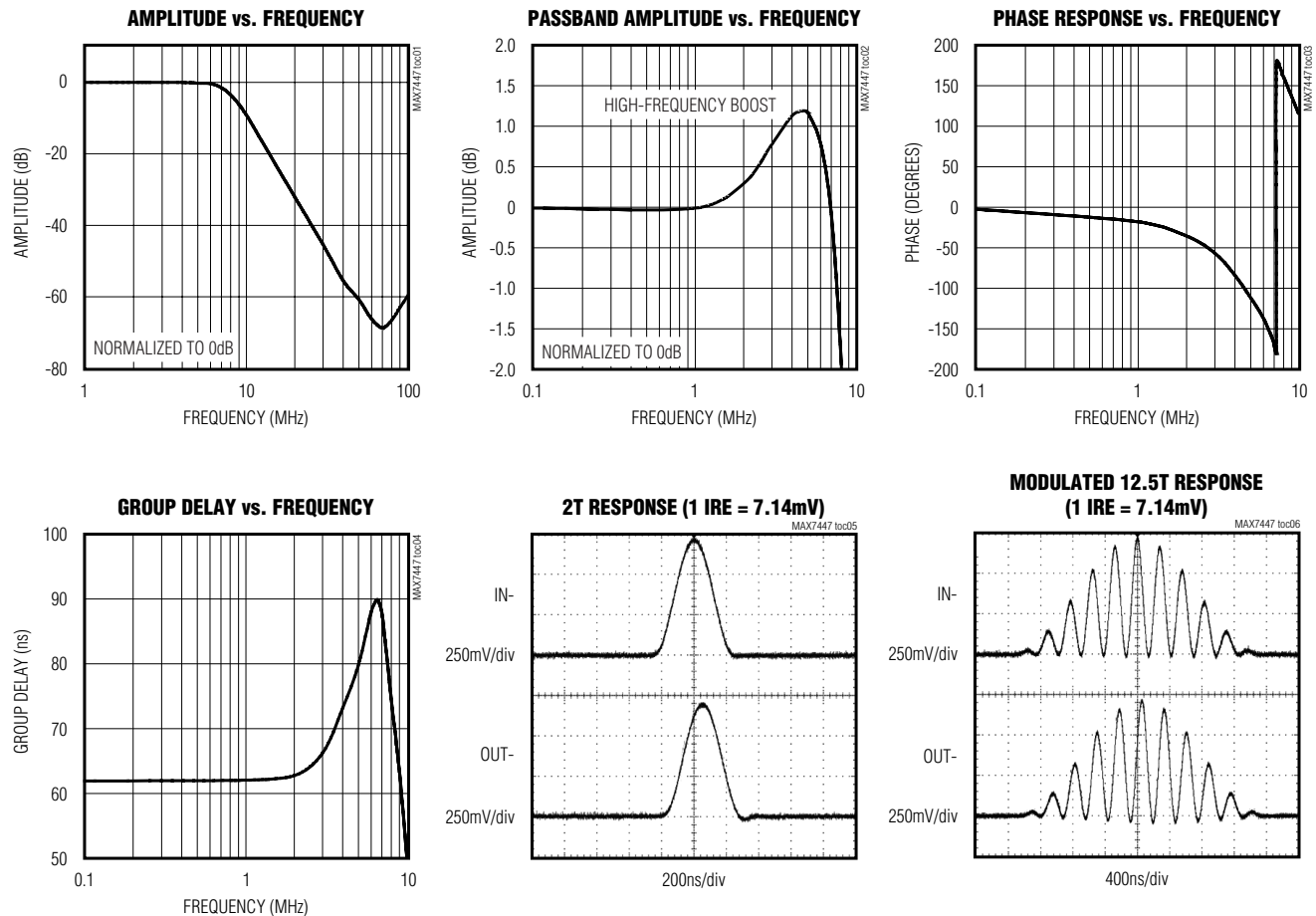

# 4-Channel S-Video, CVBS Video Filter with Asynchronous CVBS Input

## Typical Operating Characteristics (continued)

( $V_{CC} = +5V$ ,  $T_A = +25^\circ C$ , unless otherwise noted.)

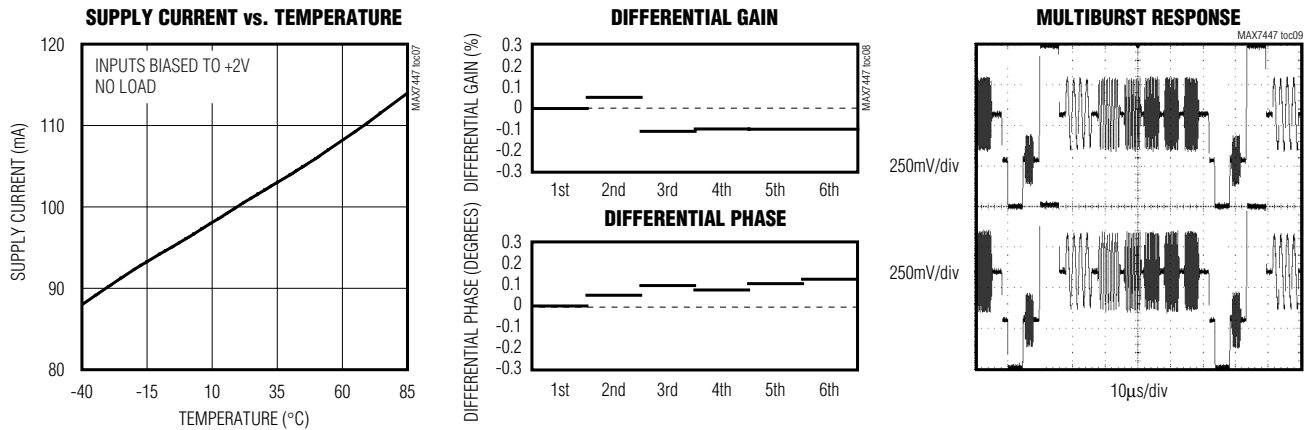

## Pin Description

PIN	NAME	FUNCTION
1	INA	Channel A Video Input. Use channel A for a CVBS video signal. AC-couple INA with a series 0.1µF capacitor.
2	INB	Channel B Video Input. Use channel B for the luma (Y) video signal. AC-couple INB with a series 0.1µF capacitor.
3	INC	Channel C Video Input. Use channel C for the chroma (C) video signal. AC-couple INC with a series 0.1µF capacitor.
4	IND	Channel D Video Input. Use channel D for a second CVBS video signal. AC-couple IND with a series 0.1µF capacitor.
5	DISABLE	Disable Logic Input. A logic-low on DISABLE enables the output buffers. A logic-high on DISABLE disables all output buffers and puts them in a high-impedance state.
6–9	GND	Ground
10	V <sub>CC</sub>	+5V Supply Input
11	OUTD	Channel D Video Output. This output can be either AC- or DC-coupled.
12	OUTC	Channel C Video Output. This output can be either AC- or DC-coupled.
13	OUTB	Channel B Video Output. This output can be either AC- or DC-coupled.
14	OUTA	Channel A Video Output. This output can be either AC- or DC-coupled.

## Detailed Description

The MAX7447 filters and buffers video-encoder DAC outputs in applications such as set-top boxes, hard-disk recorders, DVD players, and digital VCRs. The MAX7447 reconstructs and cleans up analog video signals from the output of DAC video encoders. Each channel consists of a lowpass filter and an output video buffer that drives two standard 150Ω video loads.

The MAX7447 is designed to process S-Video and CVBS video signals. The video signal processed by channel A (CVBS video signal) must include a sync pulse. This sync pulse provides the required timing for channels A, B, and C. Channel D allows an asynchronous CVBS video signal to be processed with its own local sync separator.

This device operates from a single +5V supply and has a nominal cutoff frequency of 5MHz optimized for NTSC, PAL, and SDTV.

# 4-Channel S-Video, CVBS Video Filter with Asynchronous CVBS Input

## Filter

### Filter Response

The reconstruction filter consists of two 2nd-order Sallen-Key stages. The Butterworth-type response features a maximally flat passband for NTSC and PAL bandwidths. The stopband offers at least 43dB (typ) of attenuation at a video-encoder DAC sampling frequency of 27MHz and above (see the *Typical Operating Characteristics*).

### High-Frequency Boost

Each channel has a +1.2dB high-frequency boost that increases image sharpness by compensating for signal degradation and rolloff in the video encoder.

### Output Buffers

Each output buffer has a fixed gain of +6dB and can drive two 150Ω video loads with a 2V<sub>P-P</sub> signal. The MAX7447 can drive an AC load or drive the video load directly without using a large output capacitor. The output buffers drive DC loads with an output blanking level of less than 1V.

### Output Clamp Level

When a sync pulse is detected on channel A (CVBS), the DC restore loop is activated for channels A, B, and C. Channel D's DC restore loop is activated by the sync pulse on channel D. The function of the loop is to set the DC level of the video signal to a specified voltage. See Table 1 for clamp levels and sync source.

**Table 1. Output Clamp Level and Sync Source**

CHANNEL	CLAMP LEVEL (V)	SYNC SOURCE (V)
A	0.8	Channel A
B	0.8	Channel A
C	1.6	Channel A
D	0.8	Channel D

## Applications Information

### Input Considerations

Use 0.1μF ceramic capacitors to AC-couple the inputs. These input capacitors store a DC level so the outputs are clamped to an appropriate DC voltage level.

### Output Considerations

The outputs are typically connected to a 75Ω series back-match resistor followed by the video cable. Because of the inherent divide-by-two of this configuration, the voltage on the video cable is always less than 1V, complying with industry-standard video requirements such as the European SCART standard (which allows up to 2V of DC on the video cable). The video buffer can also drive an AC-coupled video load. Good video performance is achieved with an output capacitor as low as 220μF.

### Power-Supply Bypassing and Layout

The MAX7447 operates from a single +5V supply. Bypass V<sub>CC</sub> to GND with a 0.1μF capacitor. Place all external components as close to the device as possible.

### Exposed Pads

The TSSOP-EP package has an exposed pad on the bottom of the package. This pad is electrically connected to GND and should be connected to the ground plane for improved thermal conductivity. Do not route signals under this package.

## Pin Configuration

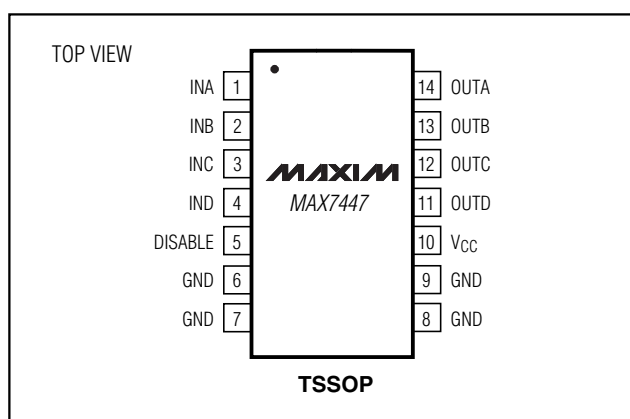

## Chip Information

TRANSISTOR COUNT: 6300

PROCESS: BiCMOS

# 4-Channel S-Video, CVBS Video Filter with Asynchronous CVBS Input

## Package Information

(The package drawing(s) in this data sheet may not reflect the most current specifications. For the latest package outline information, go to [www.maxim-ic.com/packages](http://www.maxim-ic.com/packages).)

TSSOP 4.4mm BODY:EPS

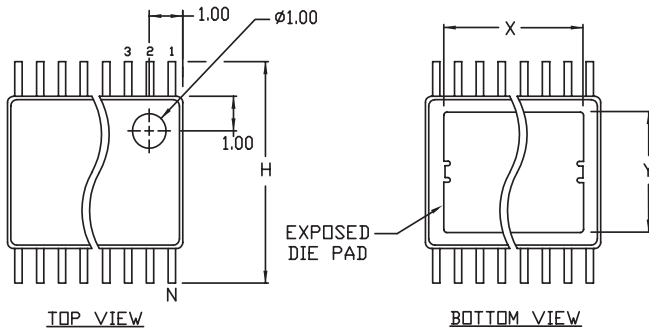

Symbol	COMMON DIMENSIONS			
	MILLIMETERS		INCHES	
	MIN.	MAX.	MIN.	MAX.
A	1.10			
A <sub>1</sub>	0.05	0.15	.002	.006
A <sub>2</sub>	0.85	0.95	.033	.037
b	0.19	0.30	.007	.012
b <sub>1</sub>	0.19	0.25	.007	.010
c	0.090	0.20	.0035	.008
c <sub>1</sub>	0.090	0.135	.0035	.0053
D	SEE VARIATIONS		SEE VARIATIONS	
E	4.30	4.50	.169	.177
e	0.65 BSC		.026 BSC	
H	6.25	6.50	.246	.256
L	0.50	0.70	.020	.028
N	SEE VARIATIONS		SEE VARIATIONS	
Y	2.85	3.15	.112	.124
α	0°	8°	0°	8°

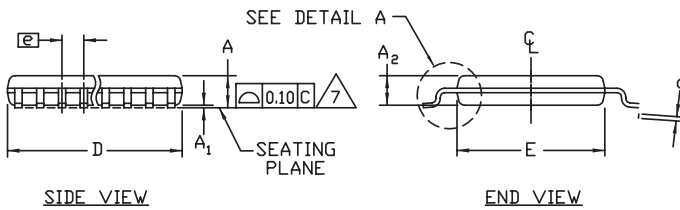

JEDEC	N	VARIATIONS			
		MILLIMETERS		INCHES	
		MIN.	MAX.	MIN.	MAX.
ABT	D	4.90	5.10	.193	.201
ACT	X	2.85	3.15	.112	.124
AET	D	6.40	6.60	.252	.260
	X	4.00	4.34	.157	.171
	D	9.60	9.80	.378	.386
	X	5.35	5.65	.211	.222

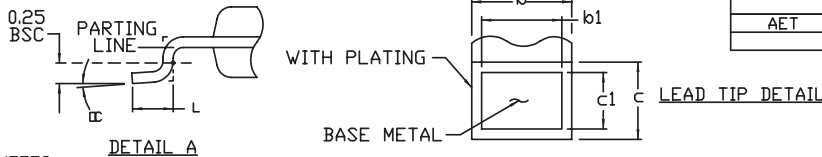

**NOTES:**

- DIMENSIONS D AND E DO NOT INCLUDE FLASH
- MOLD FLASH OR PROTRUSIONS NOT TO EXCEED 0.15mm PER SIDE
- CONTROLLING DIMENSION: MILLIMETER
- MEETS JEDEC OUTLINE MD-153. SEE JEDEC VARIATIONS TABLE.
- 'N' REFERS TO NUMBER OF LEADS
- EXPOSED PAD FLUSH WITH BOTTOM OF PACKAGE WITHIN .002"
- THE LEAD TIPS MUST LIE WITHIN A SPECIFIED ZONE. THIS TOLERANCE ZONE IS DEFINED BY TWO PARALLEL PLANES. ONE PLANE IS THE SEATING PLANE, DATUM [-C-]; THE OTHER PLANE IS AT THE SPECIFIED DISTANCE FROM [-C-] IN THE DIRECTION INDICATED.

MAXIM

PROPRIETARY INFORMATION

TITLE:  
PACKAGE OUTLINE, TSSOP, 4.40 MM BODY, EXPOSED PAD

APPROVAL	DOCUMENT CONTROL NO. 21-0108	REV B	1/1
----------	---------------------------------	----------	-----

Maxim cannot assume responsibility for use of any circuitry other than circuitry entirely embodied in a Maxim product. No circuit patent licenses are implied. Maxim reserves the right to change the circuitry and specifications without notice at any time.

6 \_\_\_\_\_ **Maxim Integrated Products, 120 San Gabriel Drive, Sunnyvale, CA 94086 408-737-7600**