

CDBN0145

$I_o = 100\text{mA}$
 $V_R = 45\text{ Volts}$

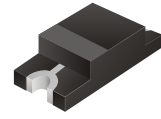

Features

- Designed for mounting on small surface
- Extremely thin package
- Low stored charge
- Majority carrier conduction

Mechanical data

- Case: 1206(3216) Standard package, molded plastic
- Terminals: Solder plated, solderable per MIL-STD-750, method 2026.
- Polarity: Indicated by cathode band.
- Mounting position: Any.
- Weight: 0.0085 gram. (approximately)

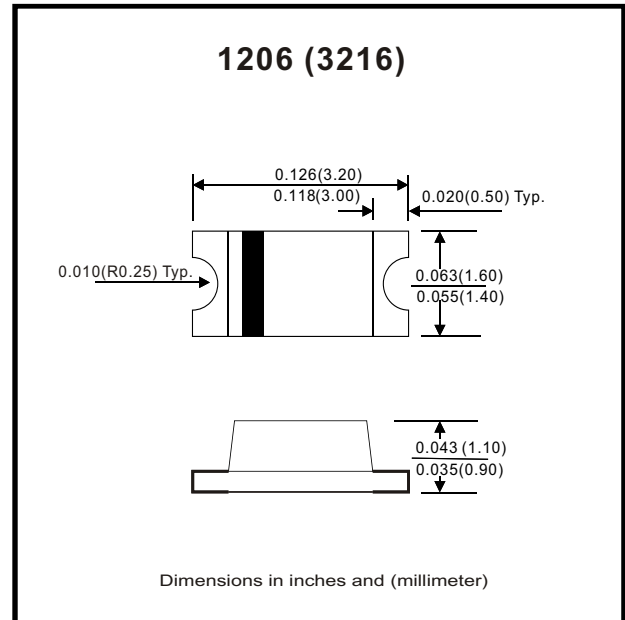

Maximum Rating (at $T_A = 25^\circ\text{C}$ unless otherwise noted)

Parameter	Conditions	Symbol	Min	Typ	Max	Unit
Repetitive peak reverse voltage		V_{RRM}			50	V
Reverse voltage		V_R			45	V
Average forward current		I_o			100	mA
Forward current , surge peak	8.3 ms single half sine-wave superimposed on rate load(JEDEC method)	I_{FSM}		1000		mA
Power Dissipation		P_D			250	mW
Storage temperature		T_{STG}	-40		+125	$^\circ\text{C}$
Junction temperature		T_j	-40		+125	$^\circ\text{C}$

Electrical Characteristics (at $T_A = 25^\circ\text{C}$ unless otherwise noted)

Parameter	Conditions	Symbol	Min	Typ	Max	Unit
Forward voltage	$I_F = 100\text{ mADC}$	V_F			0.55	V
Reverse current	$V_R = 45\text{ V}$	I_R			30	μA
Capacitance between terminals	$f = 1\text{MHz}$, and 10 VDC reverse voltage	C_T		10		pF

RATING AND CHARACTERISTIC CURVES (CDBN0145)

Fig. 1 - Forward characteristics

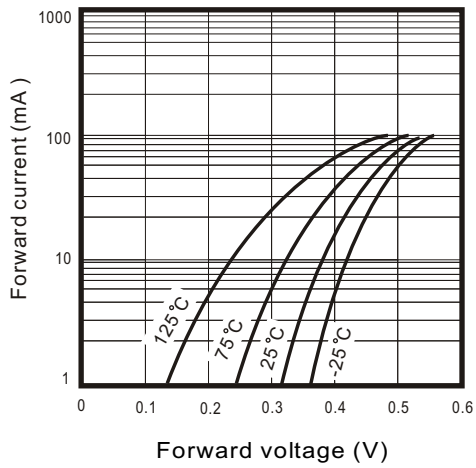

Fig. 2 - Reverse characteristics

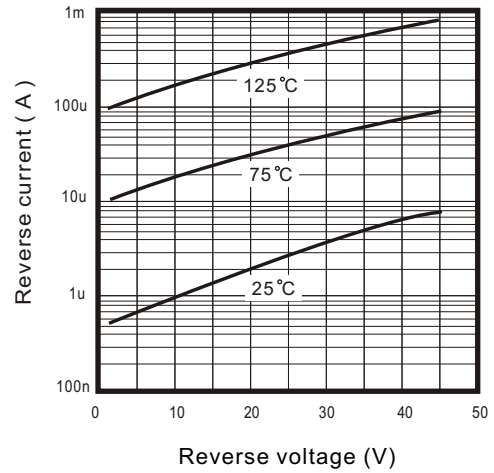

Fig. 3 - Capacitance between terminals characteristics

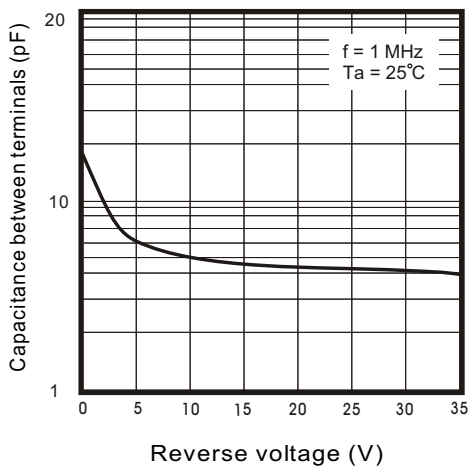

Fig. 4 - Current derating curve

