

FAN8045G3

4-CH Motor Driver (5 Input & 4 Output)

Features

- 4-CH Balanced Transformerless (BTL) Driver
- Optional Input (CH4,5) For Output CH4
- Operating Supply Voltage : 4.5 V ~ 14V
- Built-in Thermal Shut Down Circuit (TSD)
- Built-in Channel Mute Circuit
- Built-in 1-OP AMP
- TSD Monitoring Function

Description

The FAN8045G3 is a monolithic integrated circuit suitable for a 4-CH motor driver which drives a tracking actuator, a focus actuator, a sled motor, a spindle motor, and a tray motor of the CDP/CAR-CD/DVDP systems.

28-SSOPH-375SG2



Typical Application

- Compact Disk Player
- Video Compact Disk Player
- Car Compact Disk Player
- Digital Video Disk Player

Ordering Information

Device	Package	Operating Temp.
FAN8045G3	28-SSOPH-375-SG2	-35°C ~ +85°C
FAN8045G3X ^{note1}	28-SSOPH-375-SG2	-35°C ~ +85°C
FAN8045G3_NL ^{note2}	28-SSOPH-375-SG2	-35°C ~ +85°C
FAN8045G3X_NL	28-SSOPH-375-SG2	-35°C ~ +85°C

Notes:

1. X : Tape&Reel
2. NL : Lead free

Pin Assignments



Pin Definitions

Pin Number	Pin Name	I/O	Pin Function Description
1	REF1	I	Bias Voltage Input
2	IN1	I	CH1 Input
3	IN2	I	CH2 Input
4	OPIN+	I	Nomal OP-AMP Input(+)
5	OPIN-	I	Nomal OP-AMP Input(-)
6	OPOUT	O	Nomal OP-AMP Output
7	GND	-	Signal Ground
8	PVcc1	-	Power Vcc (CH1,CH2)
9	MUTE12	I	Mute 1,2
10	GND	-	Power GND(CH1,CH2)
11	DO2-	O	CH2 Drive Output (-)
12	DO2+	O	CH2 Drive Output (+)
13	DO1-	O	CH1 Drive Output (-)
14	DO1+	O	CH1 Drive Output (+)
15	DO4+	O	CH4 Drive Output (+)
16	DO4-	O	CH4 Drive Output (-)
17	DO3+	O	CH3 Drive Output (+)
18	DO3-	O	CH3 Drive Output (-)
19	GND	-	Power GND(CH3,CH4)
20	MUTE4	I	Mute 4
21	PVcc2	-	Power Vcc (CH3,CH4)
22	SVcc	-	Signal Vcc
23	IN3	I	CH3 Input
24	IN4	I	CH4 Input
25	REF2	I	REF2
26	IN5	I	CH5 Input
27	MUTE3	I	Mute 3
28	SW45	I	Select Switch For 4,5CH

Internal Block Diagram

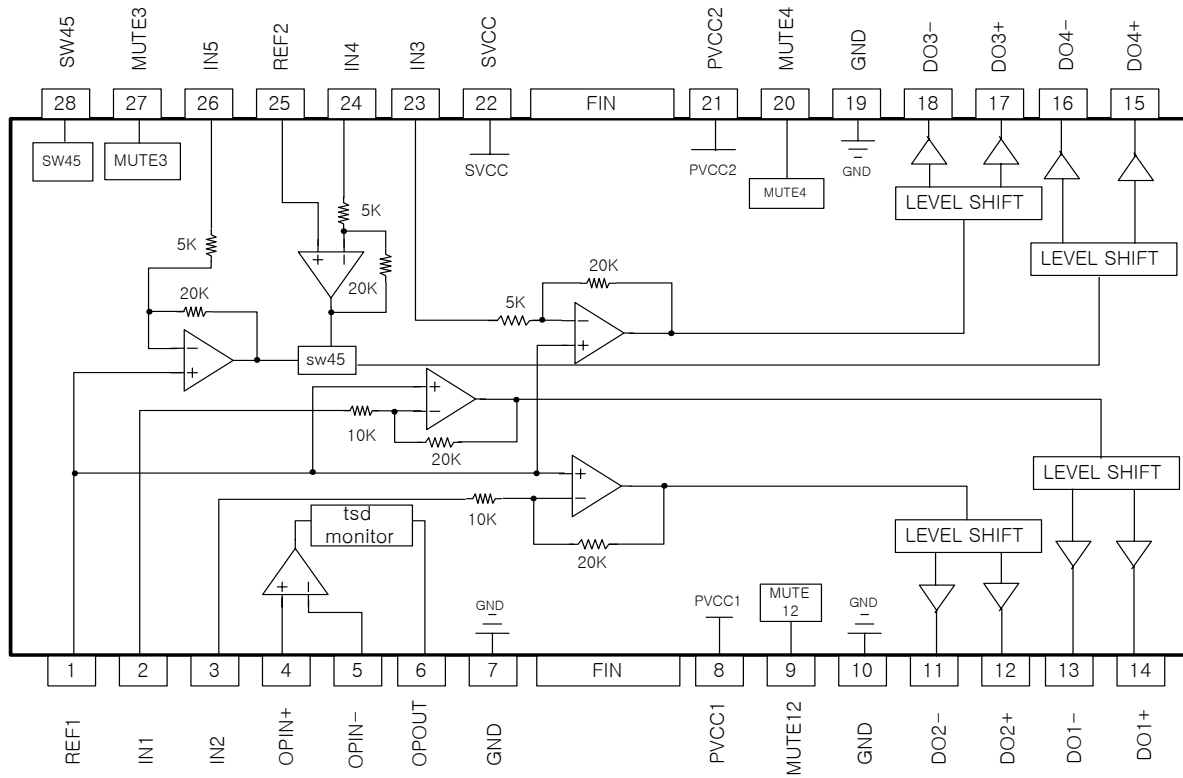

Equivalent Circuits

BTL Driver Output	SW45
BTL Input(CH1,2)	BTL Input(CH3,4)
Mute	Reference

Equivalent Circuits (Continued)

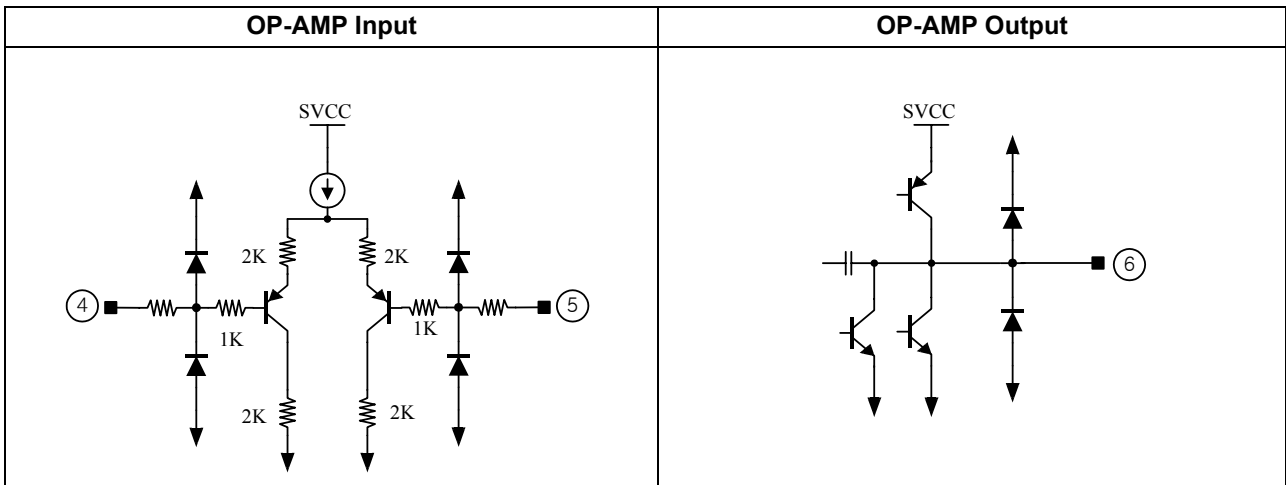

Absolute Maximum Ratings (Ta=25°C)

Parameter	Symbol	Value	Unit
Maximum Supply Voltage	SVCCMAX	18	V
	PVCC1MAX	18	V
	PVCC2MAX	18	V
Power Dissipation	PD	2.5 ^{note1,2,3}	W
Operating Temperature	TOPR	-35 ~ +85	°C
Storage Temperature	TSTG	-55 ~ +150	°C
Maximum Output Current	IOMAX	1	A

Notes:

1. When it is mounted on 70mm × 70mm × 1.6mm PCB.
2. Power dissipation decreases at the rate of 20mW/°C in TA >25°C.
3. Do not exceed PD and SOA.

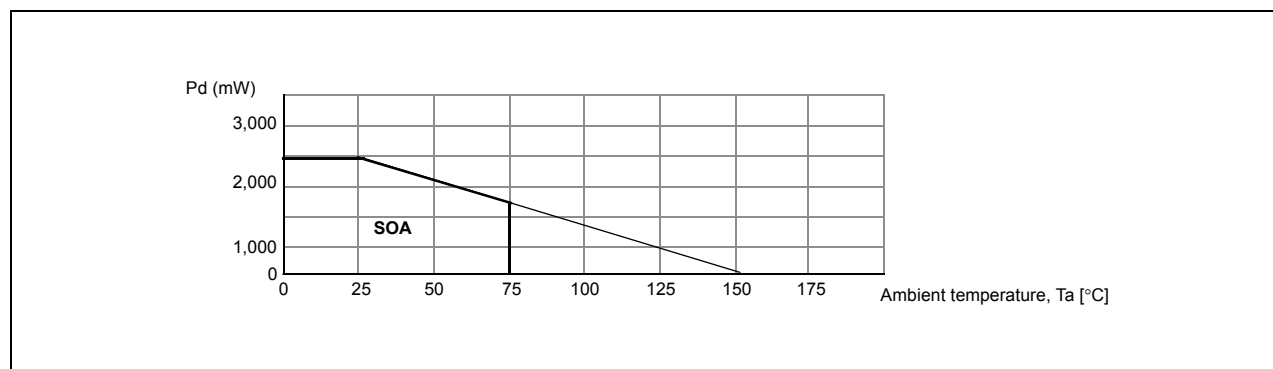

Recommended Operating Conditions (Ta=25°C)

Parameter	Symbol	Min.	Typ.	Max.	Unit
Operating Supply Voltage	SVCC	4.5	-	14	V
	PVCC1	4.5	-	SVCC	V
	PVCC2	4.5	-	SVCC	V

Electrical Characteristics

(SVCC = PVCC2 = 12V, TA = 25°C, PVCC1 = 5V, Ref1 = 1.65V, Ref2 = 2.5V, RL = 8Ω)

Parameter	Symbol	Conditions	Min.	Typ.	Max.	Unit
Quiescent Circuit Current	ICC	Under no-load	-	17	25	mA
BTL DRIVER CIRCUIT (RL=8Ω)						
Output Offset Voltage(CH12)	VOOF1	VIN=1.65V	-50	-	+50	mV
Output Offset Voltage(CH34)	VOOF2	VIN=1.65V	-100	-	+100	mV
Output Offset Voltage(CH5)	VOOF3	VIN=2.5V	-100	-	+100	mV
Maximum Output Voltage(CH12)	VOM1	PVcc1=5V, RL=8Ω	3.6	4.0	-	V
Maximum Output Voltage(CH34)	VOM2	PVcc2=12V, RL=24Ω	9.6	10.5	-	V
Close-loop Voltage Gain(CH12)	AVF	VIN= 0.3V	15.5	17.5	19.5	dB
Close-loop Voltage Gain(CH34)	AVF	VIN= 0.3V	21.5	23.5	25.5	dB
NORMAL OPAMP CIRCUIT(SVCC,PVCC2=12V)						
Input Offset Voltage	VOF	-	-10	-	+10	mV
Input Bias Current	IB1	-	-	-	300	nA
High Level Output Voltage	VOH1	-	11	-	-	V
Low Level Output Voltage	VOL1	-	-	-	0.1	V
Output Sink Current	ISINK	-	5	8	-	mA
Output Source Current	ISOU1	-	1	5	-	mA
Open Loop Voltage Gain	GVO1	f=1kHz, VIN= -75dB	-	75	-	dB
Ripple Rejection Ratio ^{note1}	RR1	f=120Hz, VIN= -20dB	-	65	-	dB
Slew Rate ^{note1}	SR1	f=120Hz, 2Vp-p	-	1	-	V/us
Common Mode Rejection Ratio ^{note1}	CMRR1	f=1kHz, VIN= -20dB	-	80	-	dB
TSD ON Voltage ^{note1}	Vtsdon	-	-	-	0.5	V
MUTE AND OTHER FUNCTION CIRCUIT						
Mute On Voltage	VMON	Pin9,20,27=Variation	-	-	0.5	V
Mute Off Voltage	VMOFF	Pin9,20,27=Variation	2	-	-	V
SW On Voltage	VSWL	Pin28=Variation	-	-	0.5	V
SW Off Voltage	VSWH	Pin28=Variation	2	-	-	V
Mute Low Level Sink Current	IMTL	VMUTE = 0V	-15	0	15	uA
Mute High Level Sink Current	IMTH	VMUTE = 5V	-	85	170	uA
SW45 Low Level Sink Current	ISWL45	SW45 = 0V	-15	0	15	uA
SW45 High Level Sink Current	ISWH45	SW45 = 5V	-	85	170	uA
REF1 Sink Current	IRL	REF1 = 1.65V	-	52	104	uA
REF2 Sink Current	IRH	REF2 = 2.5V	-	85	170	uA

Note:

1. Guaranteed field. (No EDS/ Final test .)

Application Information

1. MUTE, REF & SW45 Function

INPUT						OUTPUT					
SW45	MUTE12	MUTE3	MUTE4	REF1	REF2	BTL			PRE-AMP		OP
						CH12	CH3	CH4	CH4	CH5	
H	H	H	-	H	-	ON	ON	IN5	ON	ON	ON
H	H	L	-	H	-	ON	OFF	IN5	ON	ON	ON
H	H	H	-	L	-	OFF	OFF	OFF	OFF	ON	OFF
H	L	H	-	H	-	OFF	ON	OFF	ON	ON	ON
H	L	L	-	H	-	OFF	OFF	OFF	ON	ON	ON
L	-	-	L	-	-	OFF	OFF	OFF	OFF	ON	OFF
L	-	-	H	-	H	OFF	OFF	IN4	OFF	ON	OFF
L	-	-	H	-	L	OFF	OFF	OFF	OFF	ON	OFF

2. TSD Function

- When the chip temperature reaches to 167°C by abnormal condition, the TSD circuit is activated
- During TSD Function is activated, OP-AMP Output (pin 6) remains below 0.5V. (TSD monitoring function).
- This makes the bias current of the output drivers shut down, and all the output drivers are on cut-off state. Therefore the chip temperature begins to decrease.
- When the chip temperature falls to 63°C, the TSD circuit is deactivated and the output drivers start to operate normally.

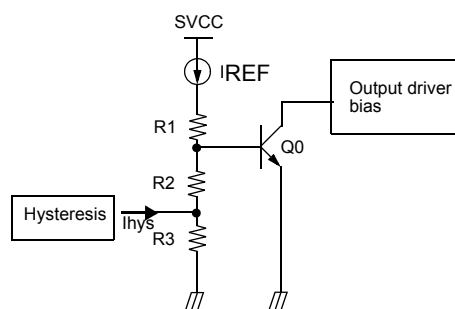

3. Notice

- If REF1(pin1) or REF2(pin25) is lower than 0.7V, BTL Output is off.
- Under Voltage Protection Function. (If SVcc is lower than 3.8V, Chip is disable. Hysterisis is 0.2V)
- Mute ON BTL OutPut Voltage is as followed:
 - Mute ON BTL Output (CH1,2) = (PVcc1) / 2
 - Mute ON BTL Output (CH3,4) = ((PVcc2-0.6) / 2
- Each output to output and output to GND short should be kept away.

Typical Performance Characteristics

Total Circuit

I_{cc}(mA)

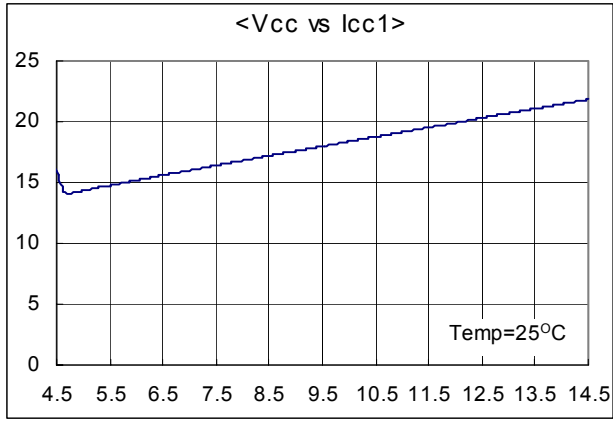

V_{cc}(V)

I_{cc}(mA)

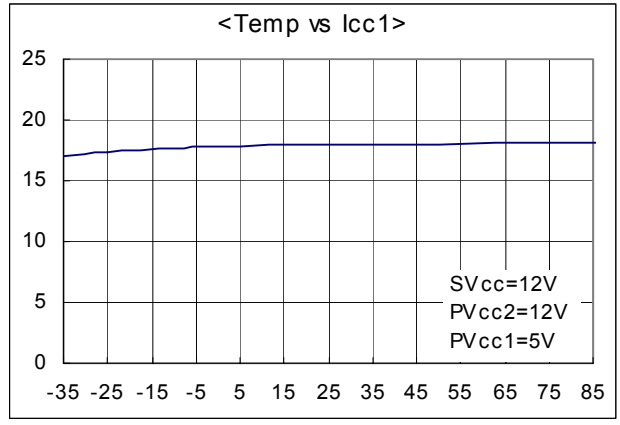

Temp(°C)

BTL Drive Part

V_{om}(V)

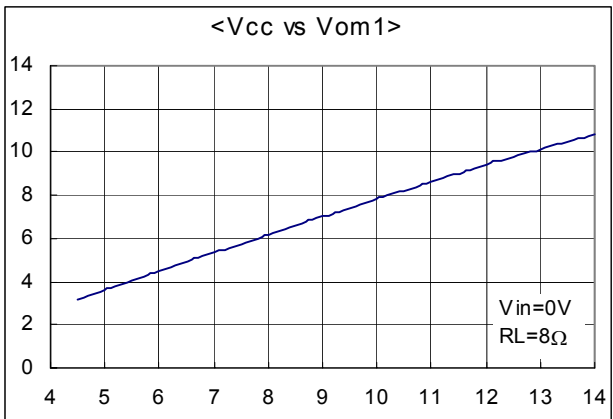

V_{cc}(V)

V_{om}(V)

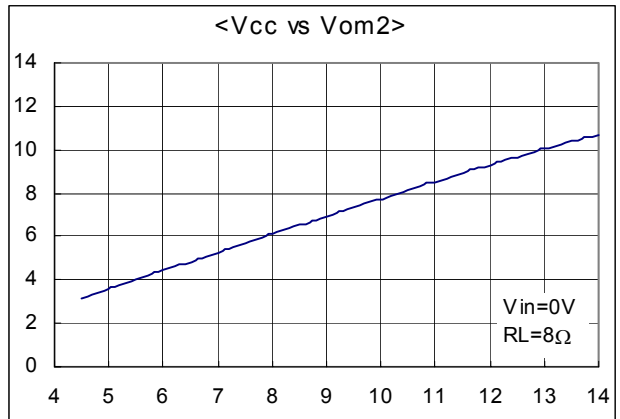

V_{cc}(V)

V_{om}(V)

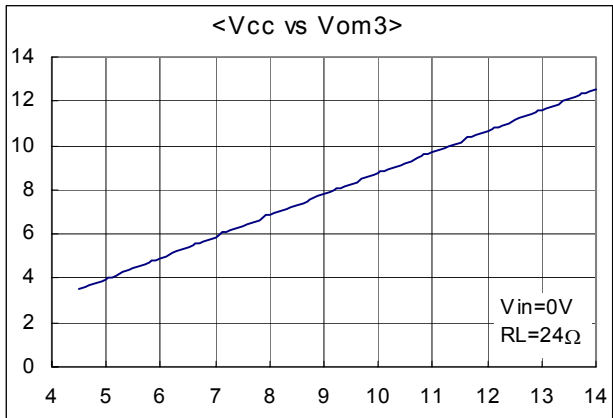

V_{cc}(V)

V_{om}(V)

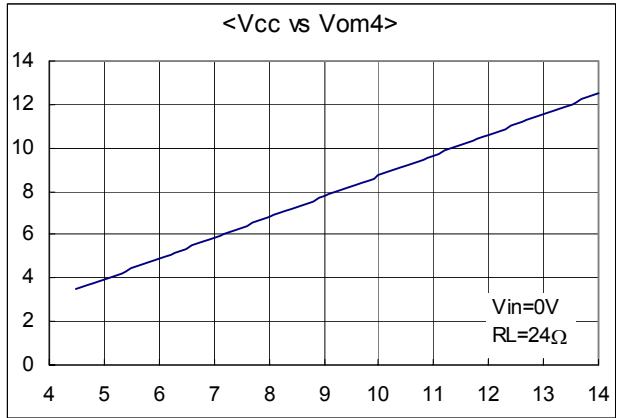

V_{cc}(V)

Typical Performance Characteristics (Continued)

Avf(dB)

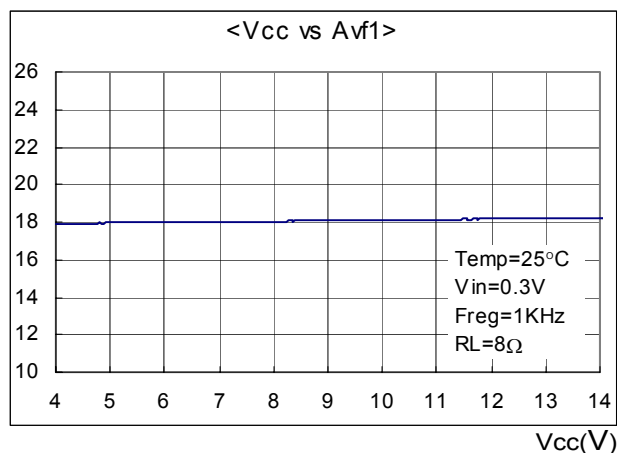

Avf(dB)

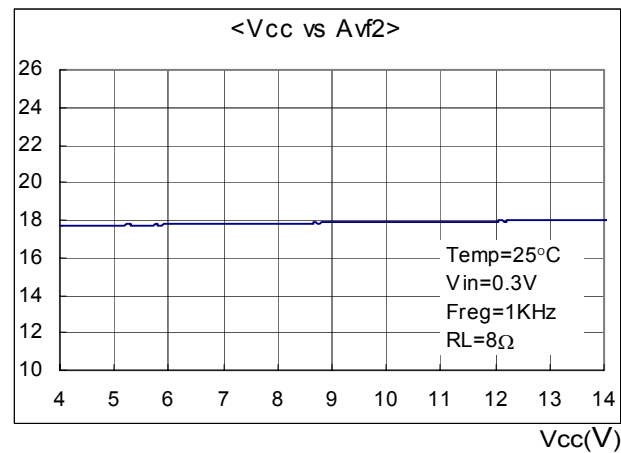

Avf(dB)

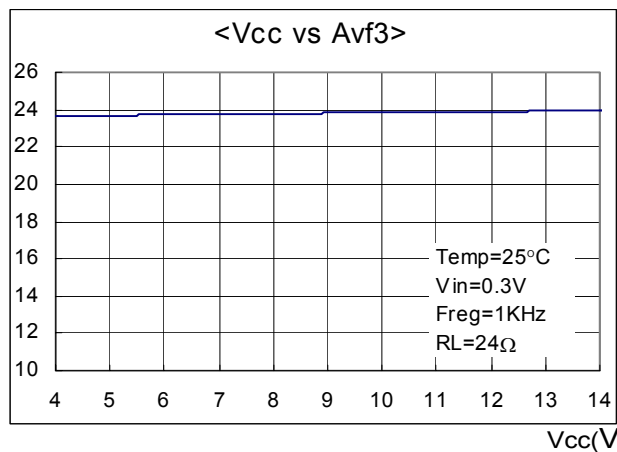

Avf(dB)

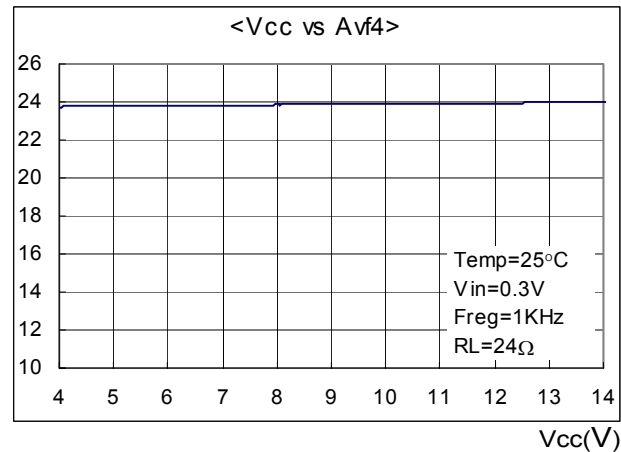

Avf(dB)

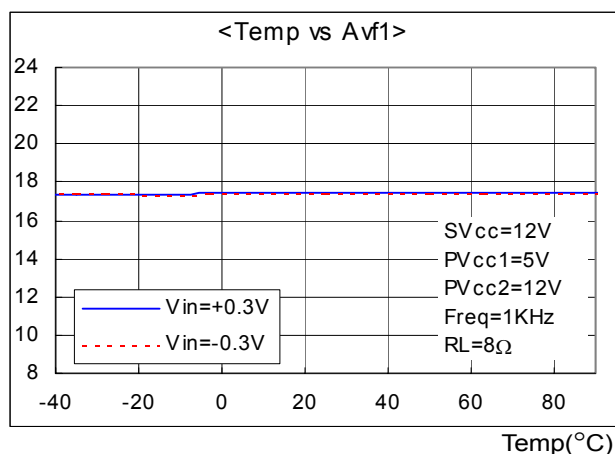

Avf(dB)

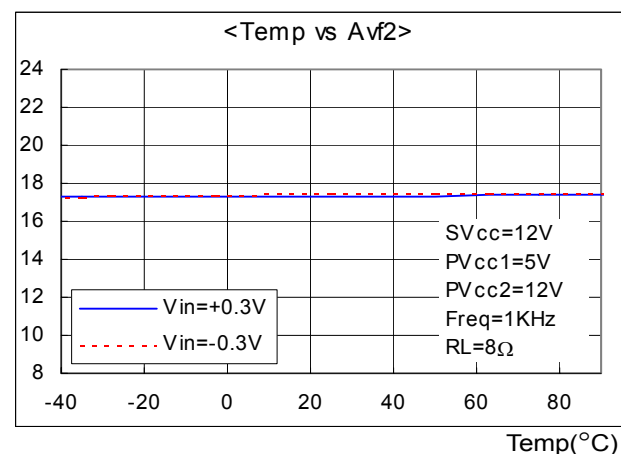

Typical Performance Characteristics (Continued)

Avf(dB)

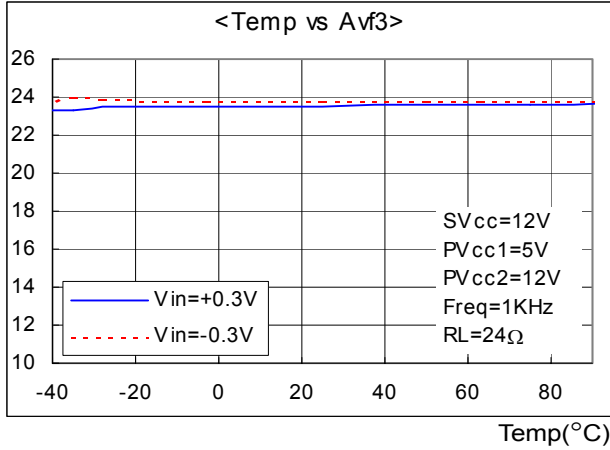

Avf(dB)

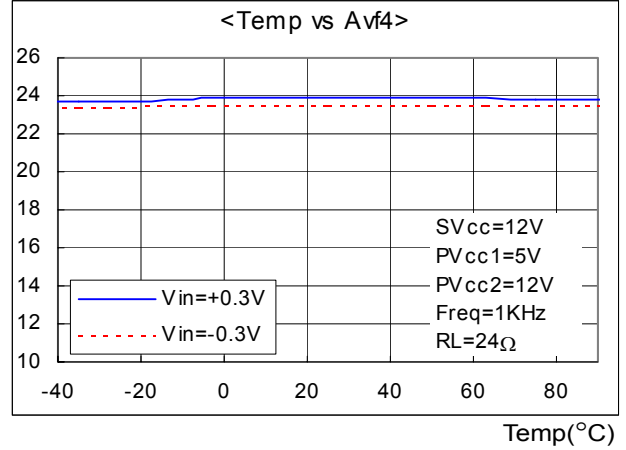

OP-AMP Part

Isink(mA)

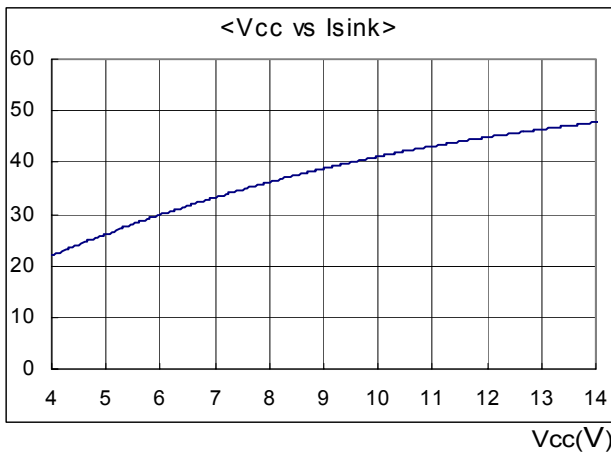

Isou(mA)

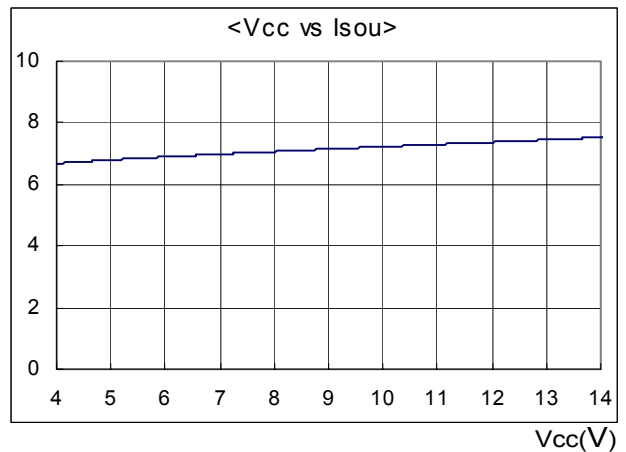

Isink(mA)

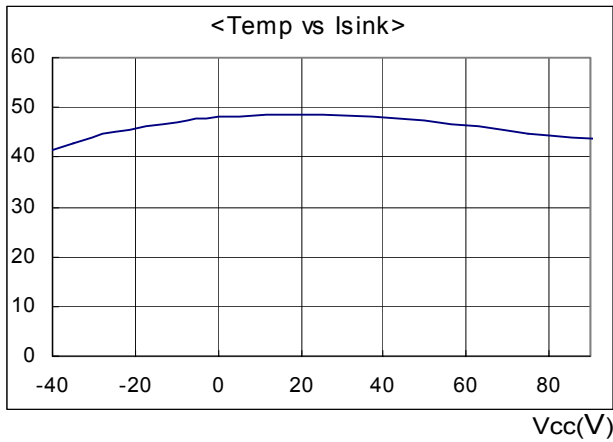

Isou(mA)

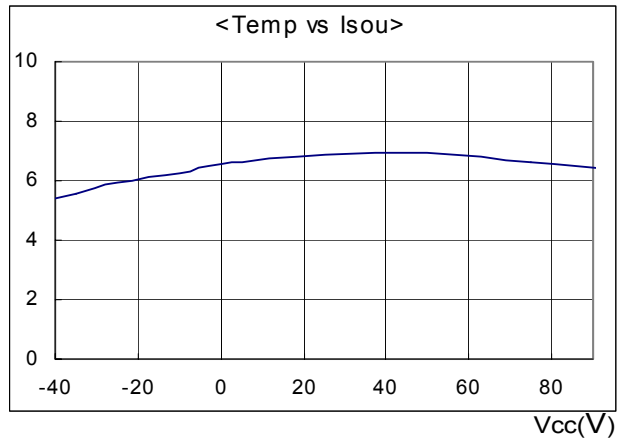

Test Circuits

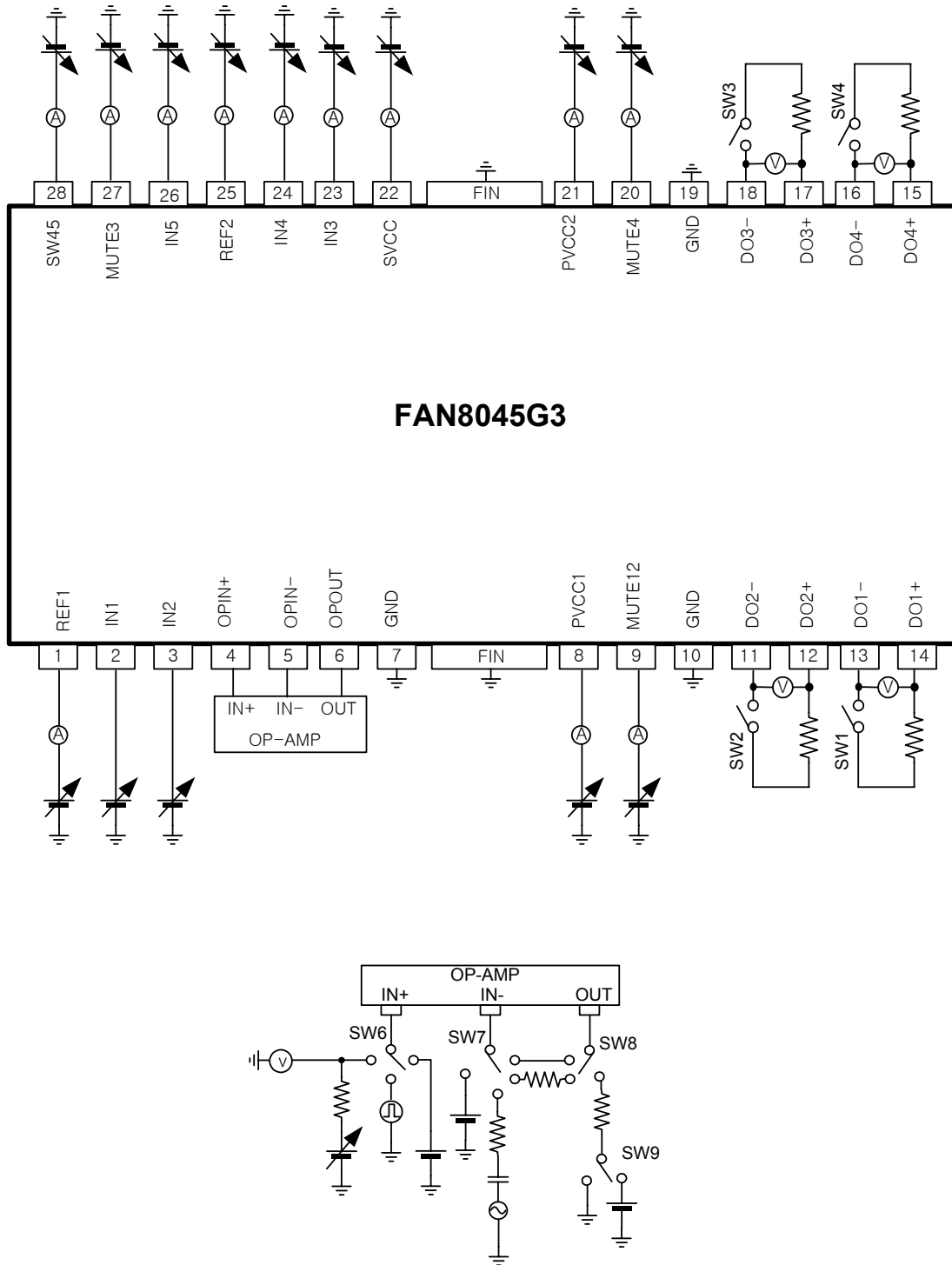

Typical Application Circuit

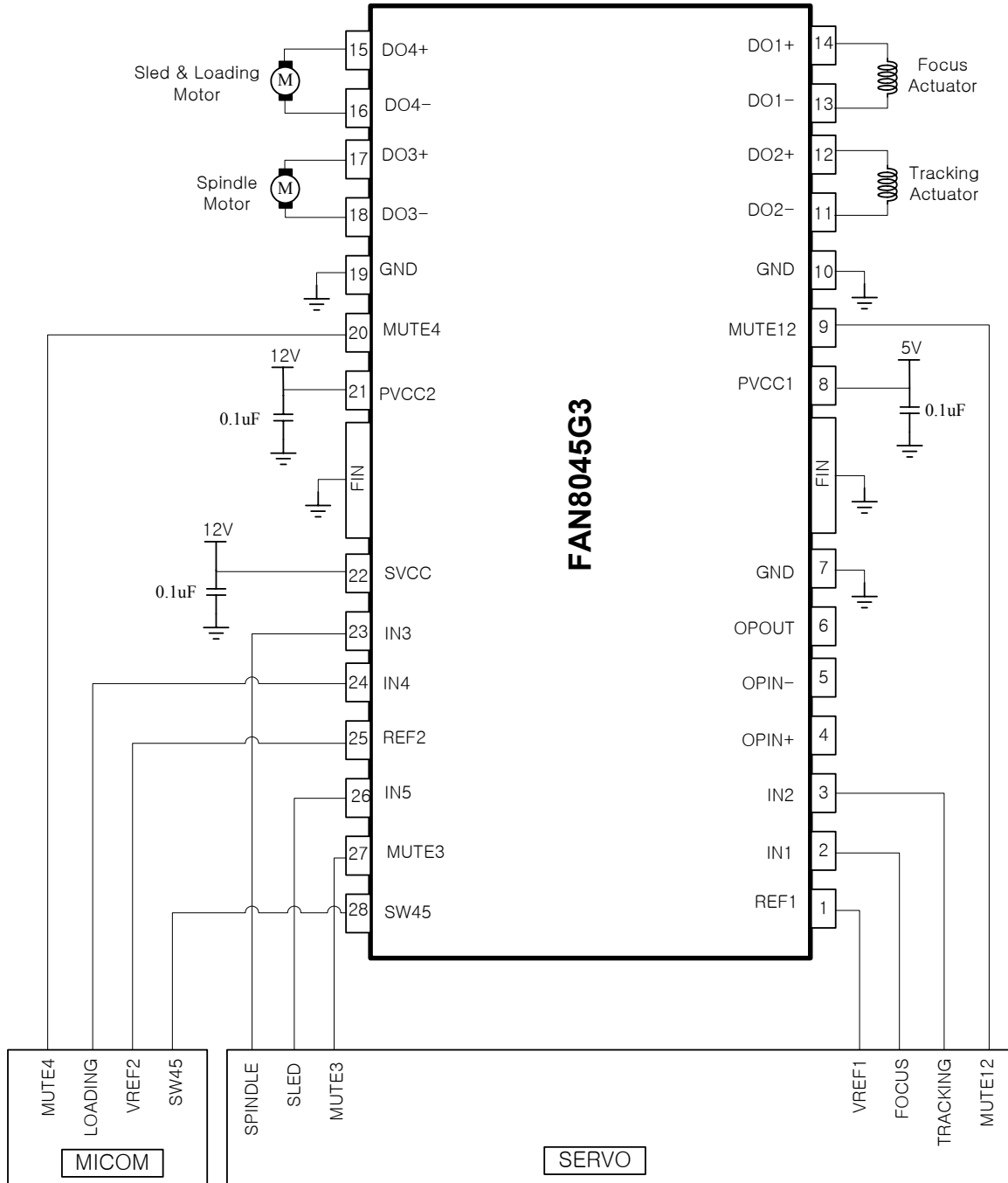

Package Dimension

28-SSOPH-375-SG2

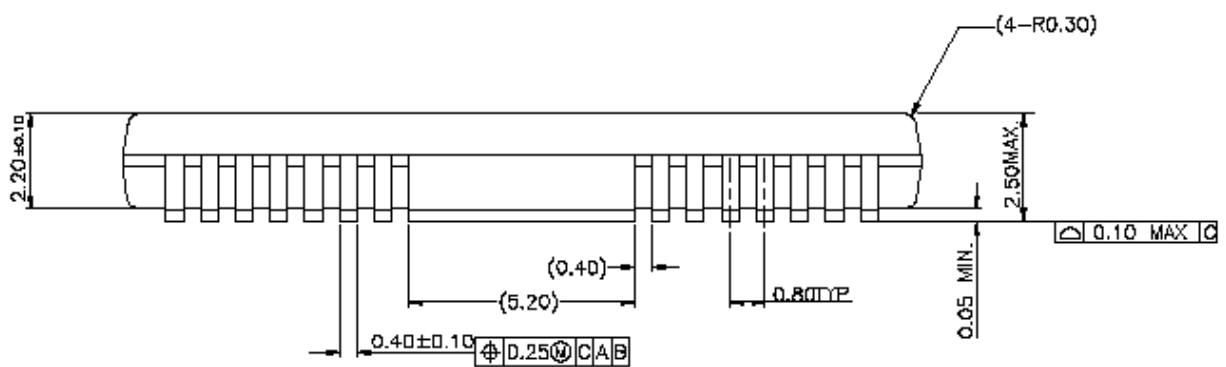
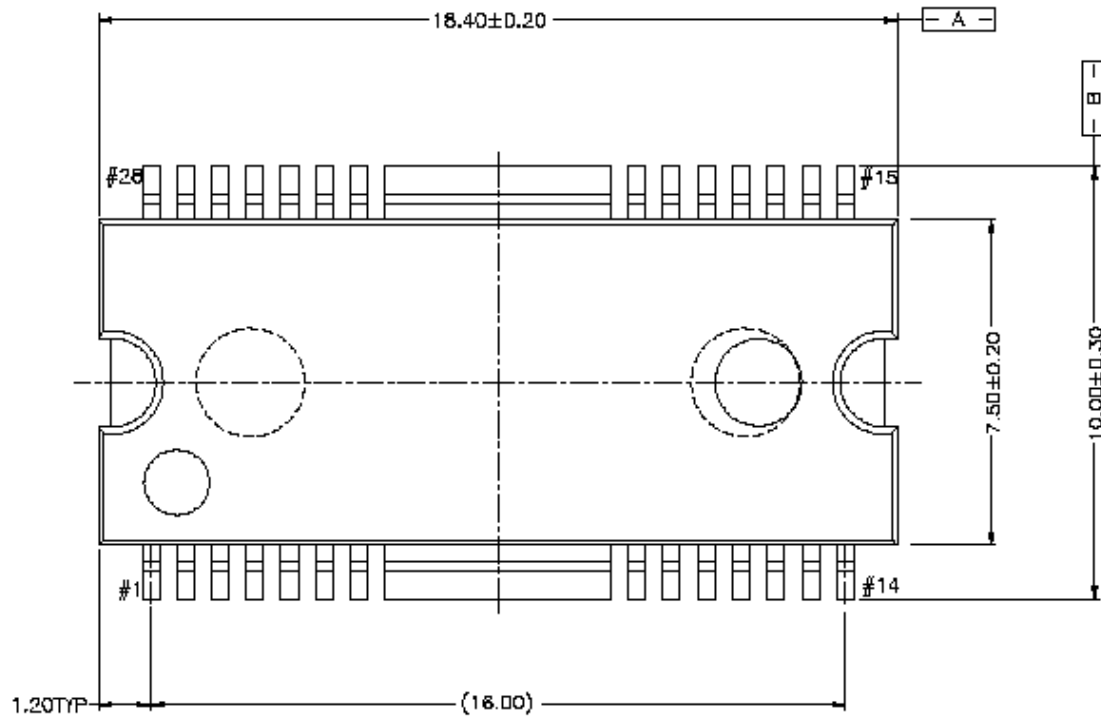

DISCLAIMER

FAIRCHILD SEMICONDUCTOR RESERVES THE RIGHT TO MAKE CHANGES WITHOUT FURTHER NOTICE TO ANY PRODUCTS HEREIN TO IMPROVE RELIABILITY, FUNCTION OR DESIGN. FAIRCHILD DOES NOT ASSUME ANY LIABILITY ARISING OUT OF THE APPLICATION OR USE OF ANY PRODUCT OR CIRCUIT DESCRIBED HEREIN; NEITHER DOES IT CONVEY ANY LICENSE UNDER ITS PATENT RIGHTS, NOR THE RIGHTS OF OTHERS.

LIFE SUPPORT POLICY

FAIRCHILD'S PRODUCTS ARE NOT AUTHORIZED FOR USE AS CRITICAL COMPONENTS IN LIFE SUPPORT DEVICES OR SYSTEMS WITHOUT THE EXPRESS WRITTEN APPROVAL OF THE PRESIDENT OF FAIRCHILD SEMICONDUCTOR CORPORATION. As used herein:

1. Life support devices or systems are devices or systems which, (a) are intended for surgical implant into the body, or (b) support or sustain life, and (c) whose failure to perform when properly used in accordance with instructions for use provided in the labeling, can be reasonably expected to result in a significant injury of the user.
2. A critical component in any component of a life support device or system whose failure to perform can be reasonably expected to cause the failure of the life support device or system, or to affect its safety or effectiveness.