

**SCHOTTKY RECTIFIER**  
*New GenIII D-61 Package*

**80 Amp**

**Major Ratings and Characteristics**



Characteristics	81CNQ...A	Units
$I_{F(AV)}$ Rectangular waveform	80	A
$V_{RRM}$ range	35 to 45	V
$I_{FSM}$ @tp = 5 $\mu$ s sine	4600	A
$V_F$ @40Apk, $T_J = 125^\circ\text{C}$ (per leg)	0.54	V
$T_J$ range	-55 to 175	$^\circ\text{C}$

**Description/Features**

The 81CNQ...A center tap Schottky rectifier module series has been optimized for low reverse leakage at high temperature. The proprietary barrier technology allows for reliable operation up to 175  $^\circ\text{C}$  junction temperature. Typical applications are in switching power supplies, converters, free-wheeling diodes, and reverse battery protection.

- 175  $^\circ\text{C}$   $T_J$  operation
- Center tap module
- High purity, high temperature epoxy encapsulation for enhanced mechanical strength and moisture resistance
- Low forward voltage drop
- High frequency operation
- Guard ring for enhanced ruggedness and long term reliability
- *New fully transfer-mold low profile, small footprint, high current package*

**Case Styles**

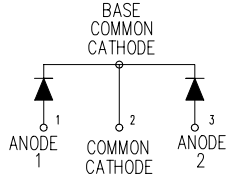
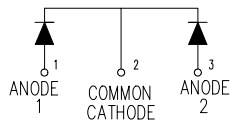
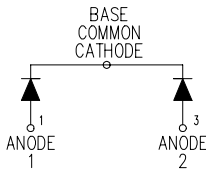
81CNQ...A	81CNQ...ASM	81CNQ...ASL
		
 <p>BASE COMMON CATHODE</p> <p>ANODE 1    COMMON CATHODE    ANODE 2</p>	 <p>ANODE 1    COMMON CATHODE    ANODE 2</p>	 <p>BASE COMMON CATHODE</p> <p>ANODE 1    ANODE 2</p>
<b>D61-8</b>	<b>D61-8-SM</b>	<b>D61-8-SL</b>

## Voltage Ratings

Part number	81CNQ035A	81CNQ040A	81CNQ045A
$V_R$ Max. DC Reverse Voltage (V)	35	40	45
$V_{RWM}$ Max. Working Peak Reverse Voltage (V)			

## Absolute Maximum Ratings

Parameters	81CNQ	Units	Conditions
$I_{F(AV)}$ Max. Average Forward Current * See Fig. 5	80	A	50% duty cycle @ $T_C = 141^\circ\text{C}$ , rectangular waveform
$I_{FSM}$ Max. Peak One Cycle Non-Repetitive Surge Current (Per Leg) * See Fig. 7	4600	A	Following any rated load condition and with rated $V_{RRM}$ applied
	790		
$E_{AS}$ Non-Repetitive Avalanche Energy (Per Leg)	54	mJ	$T_J = 25^\circ\text{C}$ , $I_{AS} = 8$ Amps, $L = 1.7$ mH
$I_{AR}$ Repetitive Avalanche Current (Per Leg)	8	A	Current decaying linearly to zero in 1 $\mu\text{sec}$ Frequency limited by $T_J$ max. $V_A = 1.5 \times V_R$ typical

## Electrical Specifications

Parameters	81CNQ	Units	Conditions
$V_{FM}$ Max. Forward Voltage Drop (Per Leg) * See Fig. 1 (1)	0.60	V	@ 40A
	0.74	V	@ 80A
	0.54	V	@ 40A
	0.66	V	@ 80A
$I_{RM}$ Max. Reverse Leakage Current (Per Leg) * See Fig. 2 (1)	5	mA	$T_J = 25^\circ\text{C}$
	45	mA	$T_J = 125^\circ\text{C}$
$C_T$ Max. Junction Capacitance (Per Leg)	2600	pF	$V_R = 5V_{DC}$ , (test signal range 100Khz to 1Mhz) $25^\circ\text{C}$
$L_S$ Typical Series Inductance (Per Leg)	5.5	nH	Measured lead to lead 5mm from package body
$dv/dt$ Max. Voltage Rate of Change (Rated $V_R$ )	10000	V/ $\mu\text{s}$	

(1) Pulse Width < 300 $\mu\text{s}$ , Duty Cycle <2%

## Thermal-Mechanical Specifications

Parameters	81CNQ	Units	Conditions
$T_J$ Max. Junction Temperature Range	-55 to 175	$^\circ\text{C}$	
$T_{stg}$ Max. Storage Temperature Range	-55 to 175	$^\circ\text{C}$	
$R_{thJC}$ Max. Thermal Resistance Junction to Case (Per Leg)	0.85	$^\circ\text{C}/\text{W}$	DC operation * See Fig. 4
$R_{thJC}$ Max. Thermal Resistance Junction to Case (Per Package)	0.42	$^\circ\text{C}/\text{W}$	DC operation
$R_{thCS}$ Typical Thermal Resistance, Case to Heatsink (D61-8 Only)	0.30	$^\circ\text{C}/\text{W}$	Mounting surface, smooth and greased Device flatness < 5 mils
wt Approximate Weight	7.8(0.28)	g(oz.)	
T Mounting Torque (D61-8 Only)	Min.	40(35)	Kg-cm (lbf-in)
	Max.	58(50)	

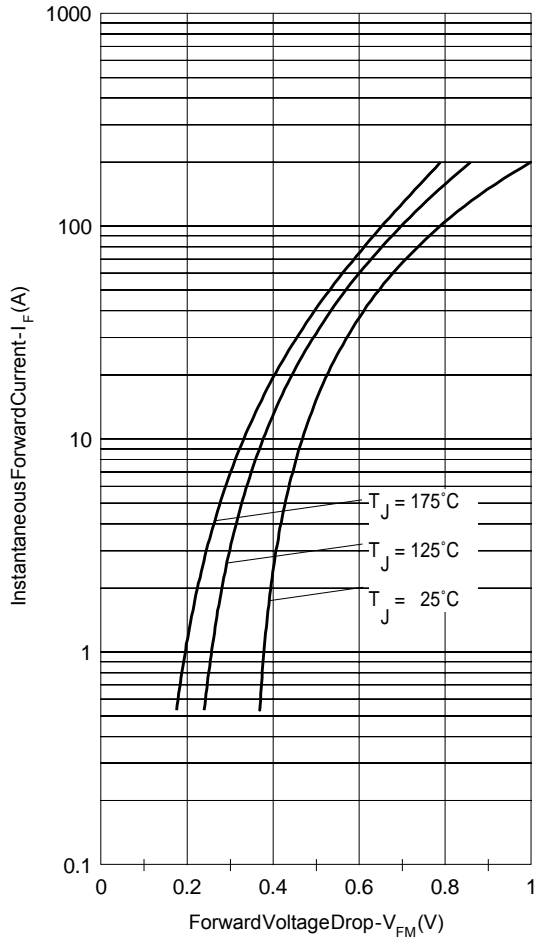

Fig. 1 - Max. Forward Voltage Drop Characteristics (Per Leg)

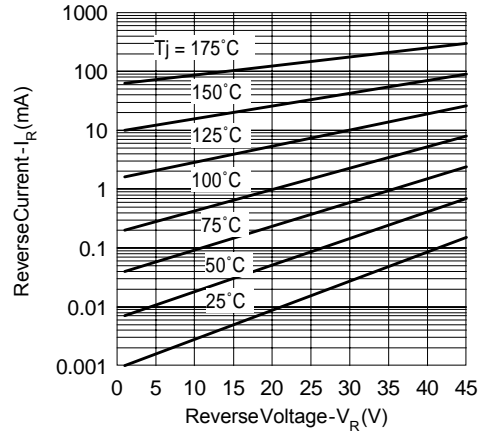

Fig. 2 - Typical Values Of Reverse Current Vs. Reverse Voltage (Per Leg)

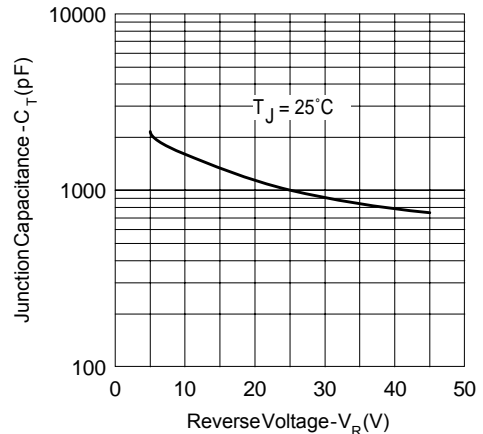

Fig. 3 - Typical Junction Capacitance Vs. Reverse Voltage (Per Leg)

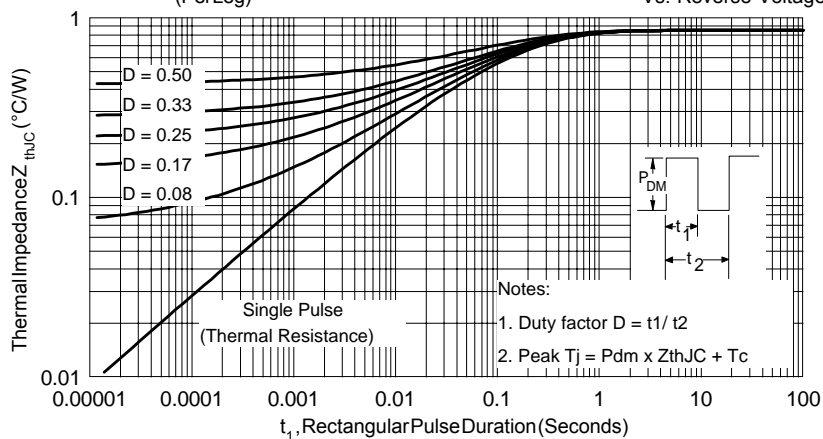

Fig. 4 - Max. Thermal Impedance  $Z_{thJC}$  Characteristics (Per Leg)

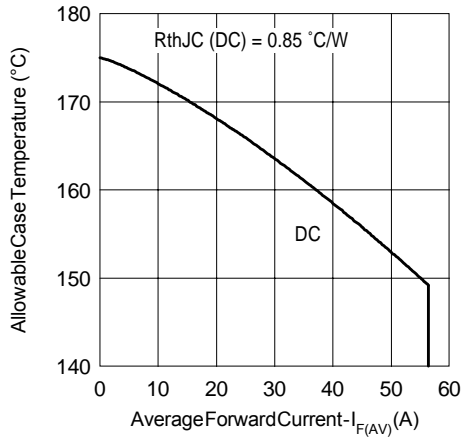

Fig. 5 - Max. Allowable Case Temperature Vs. Average Forward Current (Per Leg)

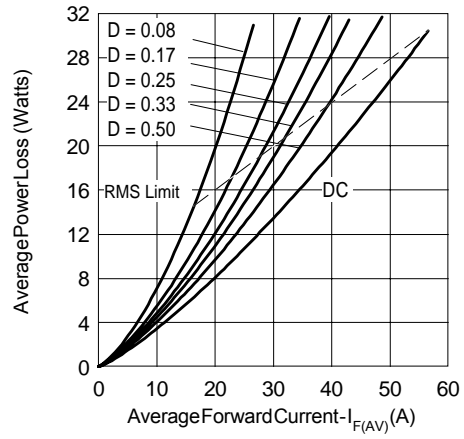

Fig. 6 - Forward Power Loss Characteristics (Per Leg)

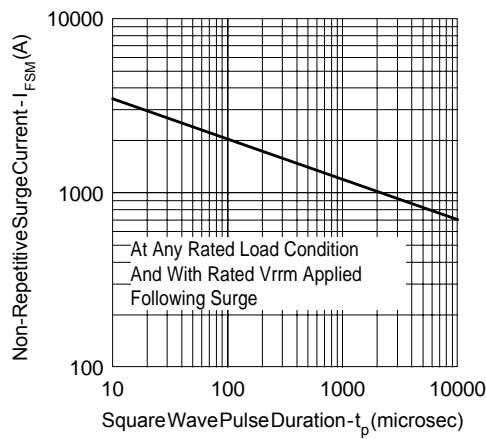

Fig. 7 - Max. Non-Repetitive Surge Current (Per Leg)

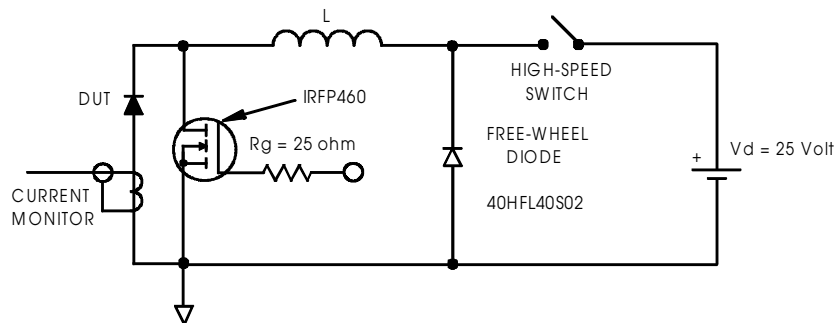
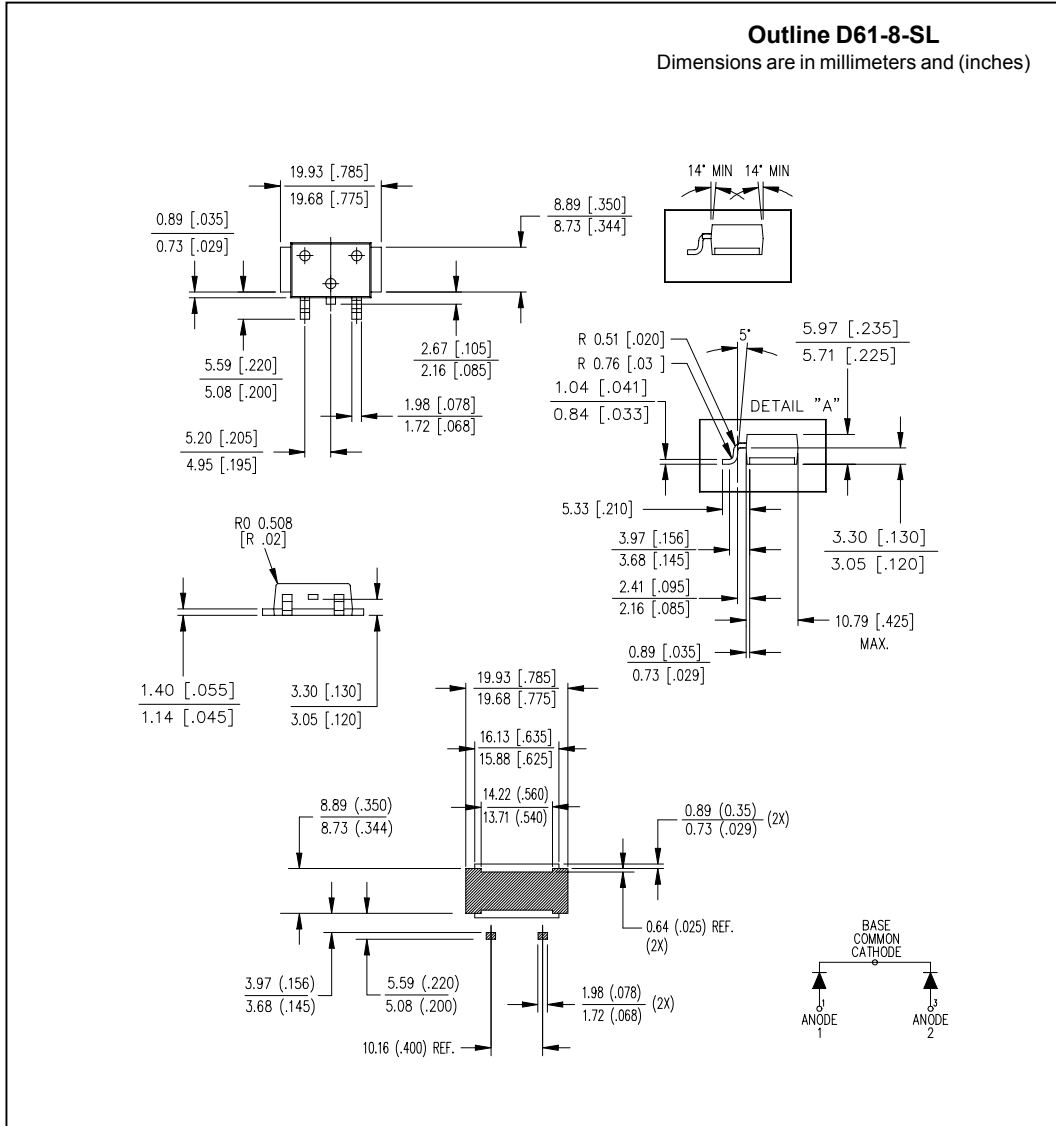

Fig. 8 - Unclamped Inductive Test Circuit



Outline Table



Part Marking Information

EXAMPLE: THIS IS A 81CNQ045A WITH  
 LOT CODE 89 09  
 ASSEMBLED ON WW 45, 2000  
 IN THE ASSEMBLY LINE "A"

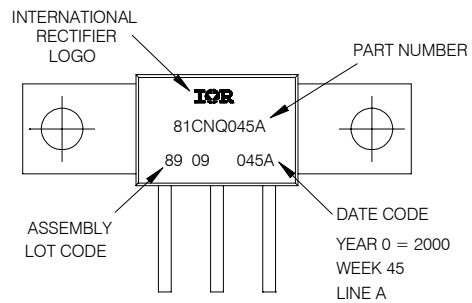

D61-8

EXAMPLE: THIS IS A 81CNQ045ASM WITH  
 LOT CODE 89 09  
 ASSEMBLED ON WW 45, 2000  
 IN THE ASSEMBLY LINE "A"

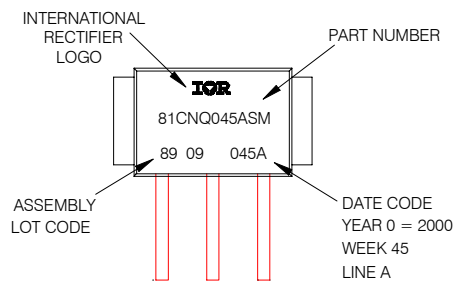

D61-8-SM

EXAMPLE: THIS IS A 81CNQ045ASL WITH  
 LOT CODE 89 09  
 ASSEMBLED ON WW 45, 2000  
 IN THE ASSEMBLY LINE "A"

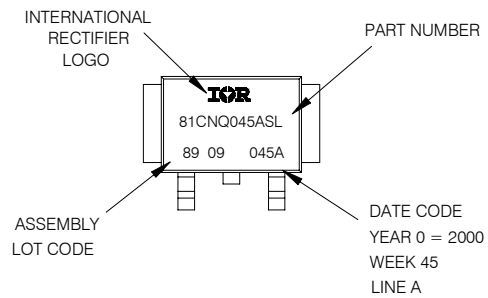

D61-8-SL

81CNQ...A Series

Bulletin 20040 rev. A 09/01

International  
**IOR** Rectifier

---

Data and specifications subject to change without notice.  
This product has been designed and qualified for Industrial Level.  
Qualification Standards can be found on IR's Web site.

International  
**IOR** Rectifier

**IR WORLD HEADQUARTERS:** 233 Kansas St., El Segundo, California 90245, USA Tel: (310) 252-7105  
TAC Fax: (310) 252-7309  
Visit us at [www.irf.com](http://www.irf.com) for sales contact information. 09/01