

Optocoupler, Photodarlington Output, With Internal R_{BE}

Features

- Internal RBE for high stability
- Isolation test voltage, 5300 V_{RMS}
- No base connection
- High isolation resistance
- Standard plastic DIP package
- Lead-free component
- Component in accordance to RoHS 2002/95/EC and WEEE 2002/96/EC

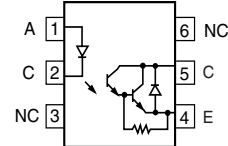
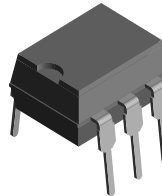

1179019



Agency Approvals

- UL1577, File No. E52744 System Code H or J, Double Protection
- BSI IEC60950 IEC60065
- CSA 93751
- DIN EN 60747-5-2 (VDE0884)
DIN EN 60747-5-5 pending
Available with Option 1
- FIMKO

driving and load circuits. They can be used to replace reed and mercury relays with advantages of long life, high speed switching and elimination of magnetic fields.

Order Information

Part	Remarks
IL66B-1	CTR > 200 %, DIP-6
IL66B-2	CTR > 750 %, DIP-6
IL66B-1X006	CTR > 200 %, DIP-6 400 mil (option 6)
IL66B-2X006	CTR > 750 %, DIP-6 400 mil (option 6)
IL66B-2X009	CTR > 750 %, SMD-6 (option 9)

For additional information on the available options refer to Option Information.

Description

The IL66B is an optically coupled isolator employing a gallium arsenide infrared emitter and a silicon photodarlington detector. Switching can be accomplished while maintaining a high degree of isolation between

Absolute Maximum Ratings

T_{amb} = 25 °C, unless otherwise specified

Stresses in excess of the absolute Maximum Ratings can cause permanent damage to the device. Functional operation of the device is not implied at these or any other conditions in excess of those given in the operational sections of this document. Exposure to absolute Maximum Rating for extended periods of the time can adversely affect reliability.

Input

Parameter	Test condition	Symbol	Value	Unit
Peak reverse voltage		V _R	6.0	V
Forward continuous current		I _F	60	mA
Power dissipation		P _{diss}	100	mW
Derate linearly from 55 °C			1.33	mW/°C

Output

Parameter	Test condition	Symbol	Value	Unit
Collector-emitter breakdown voltage		BV_{CEO}	60	V
Emitter-collector breakdown voltage		BV_{ECO}	5.0	V
Power dissipation		P_{diss}	200	mW
Derate linearly from 25 °C			2.6	mW/°C

Coupler

Parameter	Test condition	Symbol	Value	Unit
Isolation test voltage	$t = 1.0 \text{ sec.}$	V_{ISO}	5300	V_{RMS}
Isolation resistance	$V_{IO} = 500 \text{ V, } T_{amb} = 25 \text{ °C}$	R_{IO}	$\geq 10^{12}$	Ω
	$V_{IO} = 500 \text{ V, } T_{amb} = 100 \text{ °C}$	R_{IO}	$\geq 10^{11}$	Ω
Total dissipation		P_{tot}	250	mW
Derate linearly	from 25 °C		3.3	mW/°C
Creepage path			7	min mm
Clearance path			7	min mm
Storage temperature		T_{stg}	- 55 to + 150	°C
Operating temperature		T_{amb}	- 55 to + 100	°C
Lead soldering time	at 260 °C	T_{sld}	10	sec.

Electrical Characteristics

$T_{amb} = 25 \text{ °C}$, unless otherwise specified

Minimum and maximum values are testing requirements. Typical values are characteristics of the device and are the result of engineering evaluation. Typical values are for information only and are not part of the testing requirements.

Input

Parameter	Test condition	Symbol	Min	Typ.	Max	Unit
Forward voltage	$I_F = 10 \text{ mA}$	V_F		1.25	1.5	V
Reverse current	$V_R = 3.0 \text{ V}$	I_R		0.01	100	μA
Capacitance	$V_R = 0$	C_O		25		pF

Output

Parameter	Test condition	Symbol	Min	Typ.	Max	Unit
Collector-emitter breakdown voltage	$I_C = 100 \mu\text{A}$	BV_{CEO}	60			V
Collector-emitter leakage current	$V_{CE} = 50 \text{ V, } I_F = 0$	I_{CEO}		1.0	100	nA

Coupler

Parameter	Test condition	Symbol	Min	Typ.	Max	Unit
Saturation voltage	$I_C = 10 \text{ mA}$	V_{CEsat}			1.0	V

Current Transfer Ratio

Parameter	Test condition	Part	Symbol	Min	Typ.	Max	Unit
Current Transfer Ratio	$I_F = 2.0 \text{ mA, } V_{CE} = 5.0 \text{ V}$	IL66B-1	CTR	200			%
		IL66B-2	CTR	750	1000		%

Switching Characteristics

Parameter	Test condition	Symbol	Min	Typ.	Max	Unit
Turn-On, Turn-Off time	$V_{CC} = 10\text{ V}$, $I_F = 2\text{ mA}$, $R_L = 100\ \Omega$	t_{on} , t_{off}			200	μs

Typical Characteristics ($T_{amb} = 25\text{ }^\circ\text{C}$ unless otherwise specified)

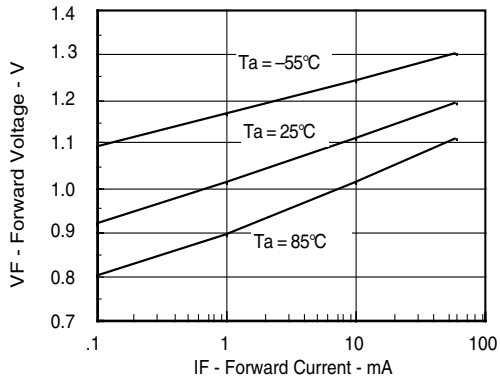

il66b_01

Figure 1. Forward Voltage vs. Forward Current

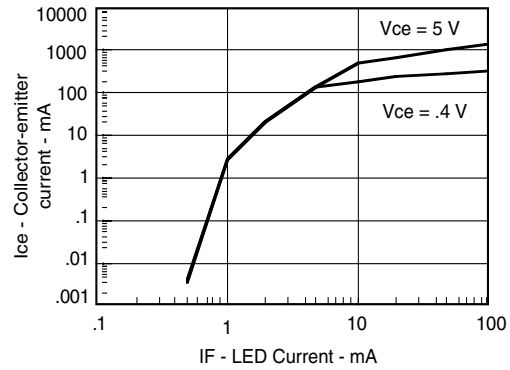

il66b_04

Figure 4. Non-Saturated and Saturated Collector Emitter Current vs. LED Current

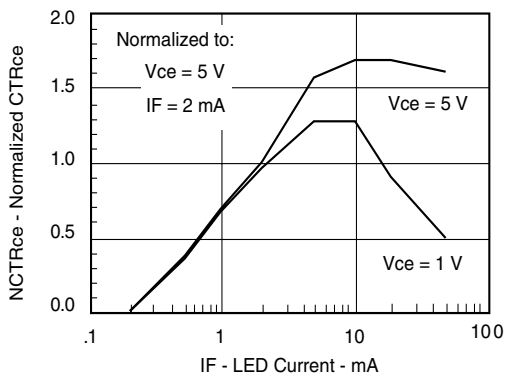

il66b_02

Figure 2. Normalized Non-saturated and Saturated CTR_{CE} vs. LED Current

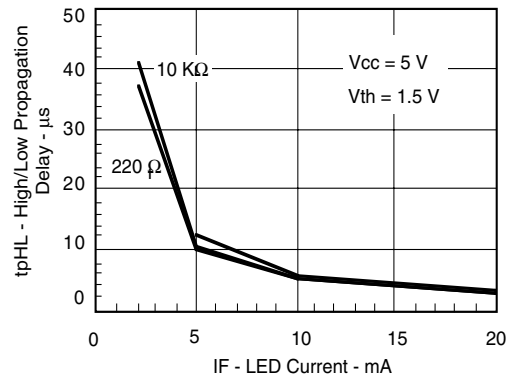

il66b_05

Figure 5. High to low Propagation Delay vs. Collector Load Resistance and LED Current

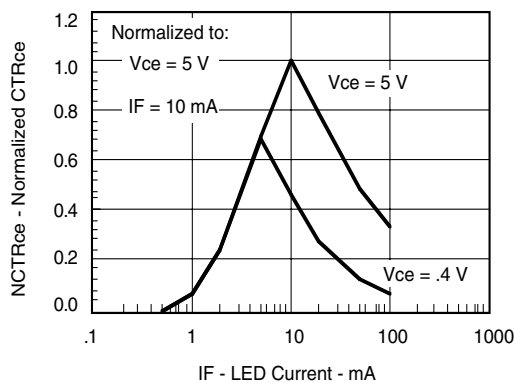

il66b_03

Figure 3. Normalized Non-saturated and Saturated CTR_{CE} vs. LED Current

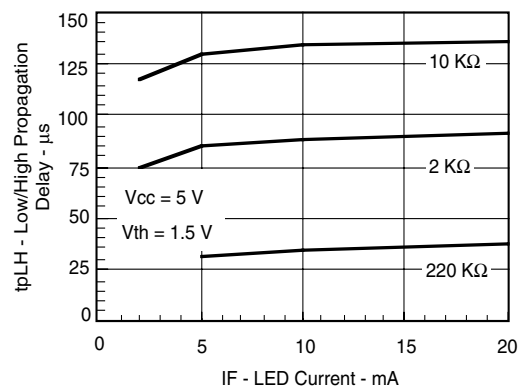

il66b_06

Figure 6. Low to High Propagation Delay vs. Collector Load Resistance and LED Current

Package Dimensions in Inches (mm)

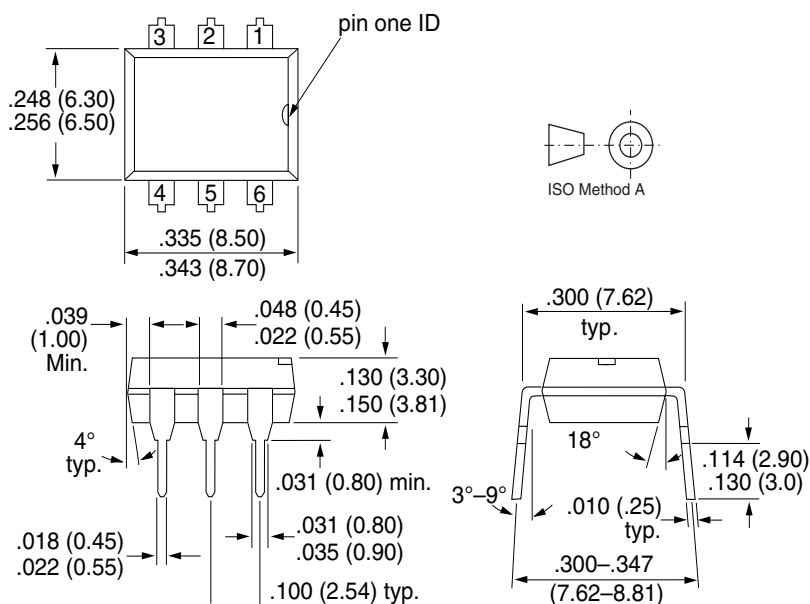

i178004

Option 6

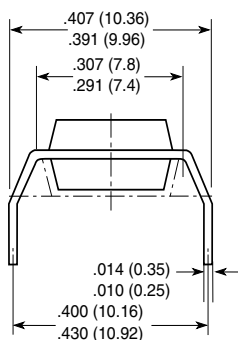

18493

Option 9

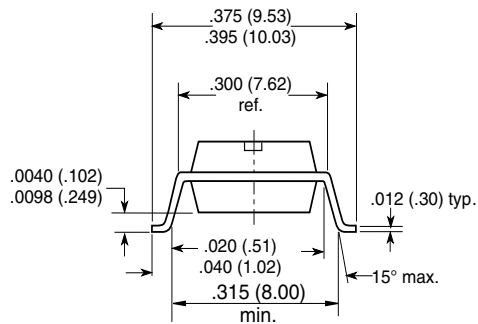

Ozone Depleting Substances Policy Statement

It is the policy of Vishay Semiconductor GmbH to

1. Meet all present and future national and international statutory requirements.
2. Regularly and continuously improve the performance of our products, processes, distribution and operating systems with respect to their impact on the health and safety of our employees and the public, as well as their impact on the environment.

It is particular concern to control or eliminate releases of those substances into the atmosphere which are known as ozone depleting substances (ODSs).

The Montreal Protocol (1987) and its London Amendments (1990) intend to severely restrict the use of ODSs and forbid their use within the next ten years. Various national and international initiatives are pressing for an earlier ban on these substances.

Vishay Semiconductor GmbH has been able to use its policy of continuous improvements to eliminate the use of ODSs listed in the following documents.

1. Annex A, B and list of transitional substances of the Montreal Protocol and the London Amendments respectively
2. Class I and II ozone depleting substances in the Clean Air Act Amendments of 1990 by the Environmental Protection Agency (EPA) in the USA
3. Council Decision 88/540/EEC and 91/690/EEC Annex A, B and C (transitional substances) respectively.

Vishay Semiconductor GmbH can certify that our semiconductors are not manufactured with ozone depleting substances and do not contain such substances.

We reserve the right to make changes to improve technical design and may do so without further notice.

Parameters can vary in different applications. All operating parameters must be validated for each customer application by the customer. Should the buyer use Vishay Semiconductors products for any unintended or unauthorized application, the buyer shall indemnify Vishay Semiconductors against all claims, costs, damages, and expenses, arising out of, directly or indirectly, any claim of personal damage, injury or death associated with such unintended or unauthorized use.

Vishay Semiconductor GmbH, P.O.B. 3535, D-74025 Heilbronn, Germany
Telephone: 49 (0)7131 67 2831, Fax number: 49 (0)7131 67 2423