

# DATA SHEET

## **MB2623**

16-bit transceiver with dual enable,  
non-inverting (3-State)

Product specification  
Supersedes data of 1993 Aug 24  
IC23 Data Handbook

1998 Jan 16

# 16-bit transceiver with dual enable, non-inverting (3-State)

## MB2623

### FEATURES

- Two 8-bit bidirectional bus interfaces
- 3-State buffers
- Power-up 3-State
- Multiple V<sub>CC</sub> and GND pins minimize switching noise
- Output capability: +64mA/−32mA
- Latch-up protection exceeds 500mA per Jedec Std 17
- ESD protection exceeds 2000 V per MIL STD 883 Method 3015 and 200 V per Machine Model
- Inputs are disabled during 3-State mode

### DESCRIPTION

The MB2623 high-performance BiCMOS device combines low static and dynamic power dissipation with high speed and high output drive.

The MB2623 is a 16-bit transceiver featuring non-inverting 3-State bus compatible outputs in both send and receive directions. The MB2623 is designed for asynchronous two-way communication between data buses.

The control function implementation allows for maximum flexibility in timing. This device allows data transmission from the A bus to the B bus or from the B bus to the A bus, depending upon the logic levels at the Enable inputs ( $\overline{1OEBA}$  and  $2OEAB$ ). The Enable inputs can be used to disable the device so that the buses are effectively isolated.

### QUICK REFERENCE DATA

SYMBOL	PARAMETER	CONDITIONS T <sub>amb</sub> = 25°C; GND = 0V	TYPICAL	UNIT
t <sub>PLH</sub> t <sub>PHL</sub>	Propagation delay nAx to nBx, or nBx to nAx	C <sub>L</sub> = 50pF; V <sub>CC</sub> = 5V	3.2 3.1	ns
C <sub>IN</sub>	Input capacitance	V <sub>I</sub> = 0V or V <sub>CC</sub>	4	pF
C <sub>I/O</sub>	I/O capacitance	V <sub>O</sub> = 0V or V <sub>CC</sub> ; 3-State	7	pF
I <sub>CCZ</sub>	Total supply current	Outputs disabled; V <sub>CC</sub> = 5.5V	50	μA

### ORDERING INFORMATION

PACKAGES	TEMPERATURE RANGE	OUTSIDE NORTH AMERICA	NORTH AMERICA	DWG NUMBER
52-pin plastic Quad Flat Pack	−40°C to +85°C	MB2623 BB	MB2623 BB	SOT379-1

### LOGIC SYMBOL

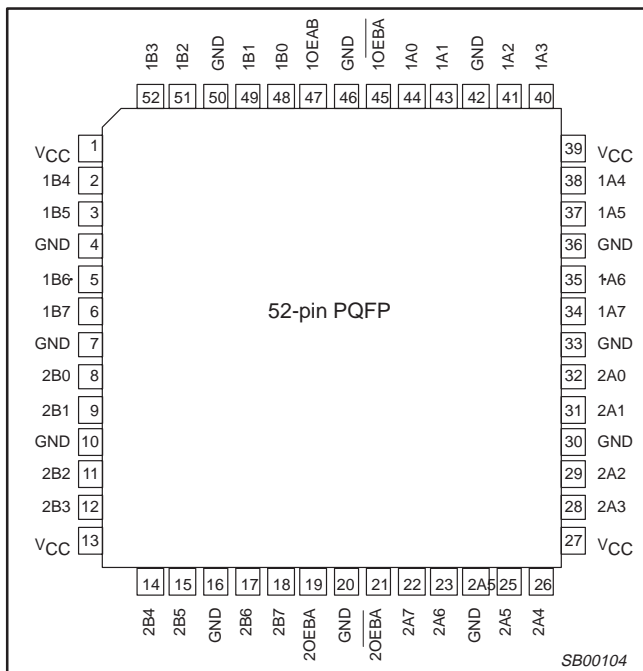

### PIN DESCRIPTION

PIN NUMBER	SYMBOL	FUNCTION
44, 43, 41, 40, 38, 37, 35, 34, 32, 31, 29, 28, 26, 25, 23, 22	1A0 – 1A7 2A0 – 2A7	Data inputs/outputs (A side)
48, 49, 51, 52, 2, 3, 5, 6, 8, 9, 11, 12, 14, 15, 17, 18	1B0 – 1B7 2B0 – 2B7	Data inputs/outputs (B side)
47, 19	1OEAB, 2OEAB	Output enable inputs (active-High)
45, 21	$\overline{1OEBA}$ , $\overline{2OEBA}$	Output enable inputs (active-Low)
4, 7, 10, 16, 20, 24, 30, 33, 36, 42, 46, 50	GND	Ground (0V)
1, 13, 27, 39	V <sub>CC</sub>	Positive supply voltage

# 16-bit transceiver with dual enable, non-inverting (3-State)

MB2623

### FUNCTION TABLE

INPUTS		OUTPUTS	
nOEBĀ	nOEAB	nAx	nBx
L	L	A = B	Inputs
H	H	Inputs	B = A
H	L	Z	Z
L	H	A = B	B = A

H = High voltage level  
 L = Low voltage level  
 Z = High impedance "off" state

### PIN CONFIGURATION

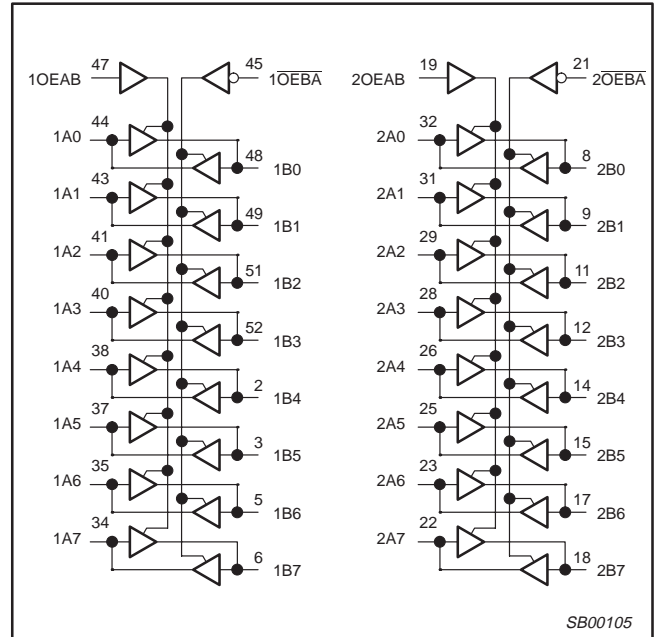

### LOGIC SYMBOL (IEEE/IEC)

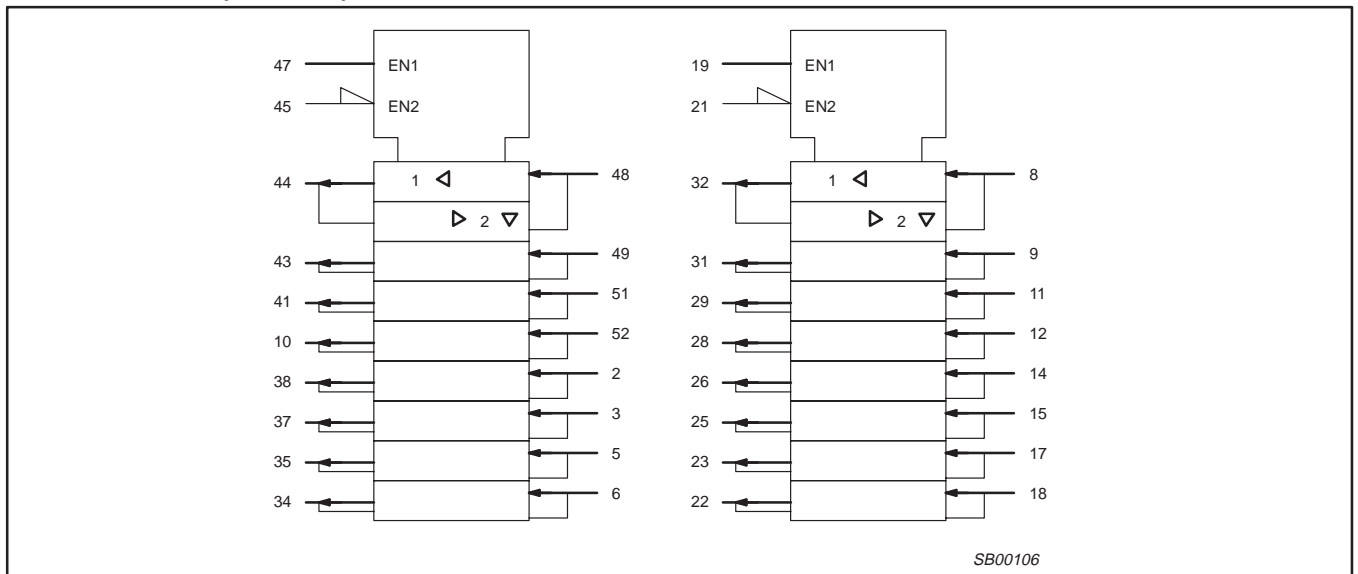

# 16-bit transceiver with dual enable, non-inverting (3-State)

MB2623

## ABSOLUTE MAXIMUM RATINGS<sup>1, 2</sup>

SYMBOL	PARAMETER	CONDITIONS	RATING	UNIT
$V_{CC}$	DC supply voltage		-0.5 to +7.0	V
$I_{IK}$	DC input diode current	$V_I < 0$	-18	mA
$V_I$	DC input voltage <sup>3</sup>		-1.2 to +7.0	V
$I_{OK}$	DC output diode current	$V_O < 0$	-50	mA
$V_{OUT}$	DC output voltage <sup>3</sup>	output in Off or High state	-0.5 to +5.5	V
$I_{OUT}$	DC output current	output in Low state	128	mA
$T_{stg}$	Storage temperature range		-65 to 150	°C

### NOTES:

- Stresses beyond those listed may cause permanent damage to the device. These are stress ratings only and functional operation of the device at these or any other conditions beyond those indicated under "recommended operating conditions" is not implied. Exposure to absolute-maximum-rated conditions for extended periods may affect device reliability.
- The performance capability of a high-performance integrated circuit in conjunction with its thermal environment can create junction temperatures which are detrimental to reliability. The maximum junction temperature of this integrated circuit should not exceed 150°C.
- The input and output voltage ratings may be exceeded if the input and output current ratings are observed.

## RECOMMENDED OPERATING CONDITIONS

SYMBOL	PARAMETER	LIMITS		UNIT
		Min	Max	
$V_{CC}$	DC supply voltage	4.5	5.5	V
$V_I$	Input voltage	0	$V_{CC}$	V
$V_{IH}$	High-level input voltage	2.0		V
$V_{IL}$	Low-level Input voltage		0.8	V
$I_{OH}$	High-level output current		-32	mA
$I_{OL}$	Low-level output current		64	mA
$\Delta t/\Delta v$	Input transition rise or fall rate	0	10	ns/V
$T_{amb}$	operating free-air temperature range	-40	+85	°C

# 16-bit transceiver with dual enable, non-inverting (3-State)

MB2623

## DC ELECTRICAL CHARACTERISTICS

SYMBOL	PARAMETER	TEST CONDITIONS	LIMITS					UNIT
			T <sub>amb</sub> = +25°C			T <sub>amb</sub> = -40°C to +85°C		
			Min	Typ	Max	Min	Max	
V <sub>IK</sub>	Input clamp voltage	V <sub>CC</sub> = 4.5V; I <sub>IK</sub> = -18mA		-0.9	-1.2		-1.2	V
V <sub>OH</sub>	High-level output voltage	V <sub>CC</sub> = 4.5V; I <sub>OH</sub> = -3mA; V <sub>I</sub> = V <sub>IL</sub> or V <sub>IH</sub>	2.5	2.9		2.5		V
		V <sub>CC</sub> = 5.0V; I <sub>OH</sub> = -3mA; V <sub>I</sub> = V <sub>IL</sub> or V <sub>IH</sub>	3.0	3.4		3.0		V
		V <sub>CC</sub> = 4.5V; I <sub>OH</sub> = -32mA; V <sub>I</sub> = V <sub>IL</sub> or V <sub>IH</sub>	2.0	2.4		2.0		V
V <sub>OL</sub>	Low-level output voltage	V <sub>CC</sub> = 4.5V; I <sub>OL</sub> = 64mA; V <sub>I</sub> = V <sub>IL</sub> or V <sub>IH</sub>		0.42	0.55		0.55	V
I <sub>I</sub>	Input leakage current	Control pins V <sub>CC</sub> = 5.5V; V <sub>I</sub> = GND or 5.5V		±0.01	±1.0		±1.0	µA
		Data pins V <sub>CC</sub> = 5.5V; V <sub>I</sub> = GND or 5.5V		±5	±100		±100	µA
I <sub>OFF</sub>	Power-off leakage current	V <sub>CC</sub> = 0.0V; V <sub>O</sub> or V <sub>I</sub> ≤ 4.5V		±5.0	±50		±50	µA
I <sub>PU</sub> /I <sub>PD</sub>	Power-up/down 3-State output current	V <sub>CC</sub> = 2.0V; V <sub>O</sub> = 0.5V; V <sub>I</sub> = GND or V <sub>CC</sub> ; V <sub>OE</sub> = V <sub>CC</sub> ; V <sub>OE</sub> = GND		±5.0	±100		±100	µA
I <sub>IH</sub> + I <sub>OZH</sub>	3-State output High current	V <sub>CC</sub> = 5.5V; V <sub>O</sub> = 2.7V; V <sub>I</sub> = V <sub>IL</sub> or V <sub>IH</sub>		5.0	50		50	µA
I <sub>IL</sub> + I <sub>OZL</sub>	3-State output Low current	V <sub>CC</sub> = 5.5V; V <sub>O</sub> = 0.5V; V <sub>I</sub> = V <sub>IL</sub> or V <sub>IH</sub>		-5.0	-50		-50	µA
I <sub>CEx</sub>	Output High leakage current	V <sub>CC</sub> = 5.5V; V <sub>O</sub> = 5.5V; V <sub>I</sub> = GND or V <sub>CC</sub>		5.0	50		50	µA
I <sub>O</sub>	Output current <sup>1</sup>	V <sub>CC</sub> = 5.5V; V <sub>O</sub> = 2.5V	-50	-100	-180	-50	-180	mA
I <sub>CCH</sub>	Quiescent supply current	V <sub>CC</sub> = 5.5V; Outputs High, V <sub>I</sub> = GND or V <sub>CC</sub>		50	100		100	µA
I <sub>CCL</sub>		V <sub>CC</sub> = 5.5V; Outputs Low, V <sub>I</sub> = GND or V <sub>CC</sub>		48	60		60	mA
I <sub>CCZ</sub>		V <sub>CC</sub> = 5.5V; Outputs 3-State; V <sub>I</sub> = GND or V <sub>CC</sub>		50	100		100	µA
ΔI <sub>CC</sub>	Additional supply current per input pin <sup>2</sup>	V <sub>CC</sub> = 5.5V; one input at 3.4V, other inputs at V <sub>CC</sub> or GND		0.5	1.5		1.5	mA

### NOTES:

- Not more than one output should be tested at a time, and the duration of the test should not exceed one second.
- This is the increase in supply current for each input at 3.4V.

## AC CHARACTERISTICS

GND = 0V, t<sub>R</sub> = t<sub>F</sub> = 2.5ns, C<sub>L</sub> = 50pF, R<sub>L</sub> = 500Ω

SYMBOL	PARAMETER	WAVEFORM	LIMITS					UNIT
			T <sub>amb</sub> = +25°C V <sub>CC</sub> = +5.0V			T <sub>amb</sub> = -40 to +85°C V <sub>CC</sub> = +5.0V ±0.5V		
			Min	Typ	Max	Min	Max	
t <sub>PLH</sub> t <sub>PHL</sub>	Propagation delay An to Bn or Bn to An	1	1.2 1.2	3.2 3.1	4.5 4.5	1.2 1.2	5.1 5.1	ns
t <sub>PZH</sub> t <sub>PZL</sub>	Output enable time to High and Low level	2	1.5 1.7	4.8 5.4	6.5 6.8	1.5 1.7	7.2 7.8	ns
t <sub>PHZ</sub> t <sub>PLZ</sub>	Output disable time from High and Low level	2	1.5 1.4	4.7 4.2	6.5 5.8	1.5 1.4	7.2 6.5	ns



# 16-bit transceiver with dual enable, non-inverting (3-State)

MB2623

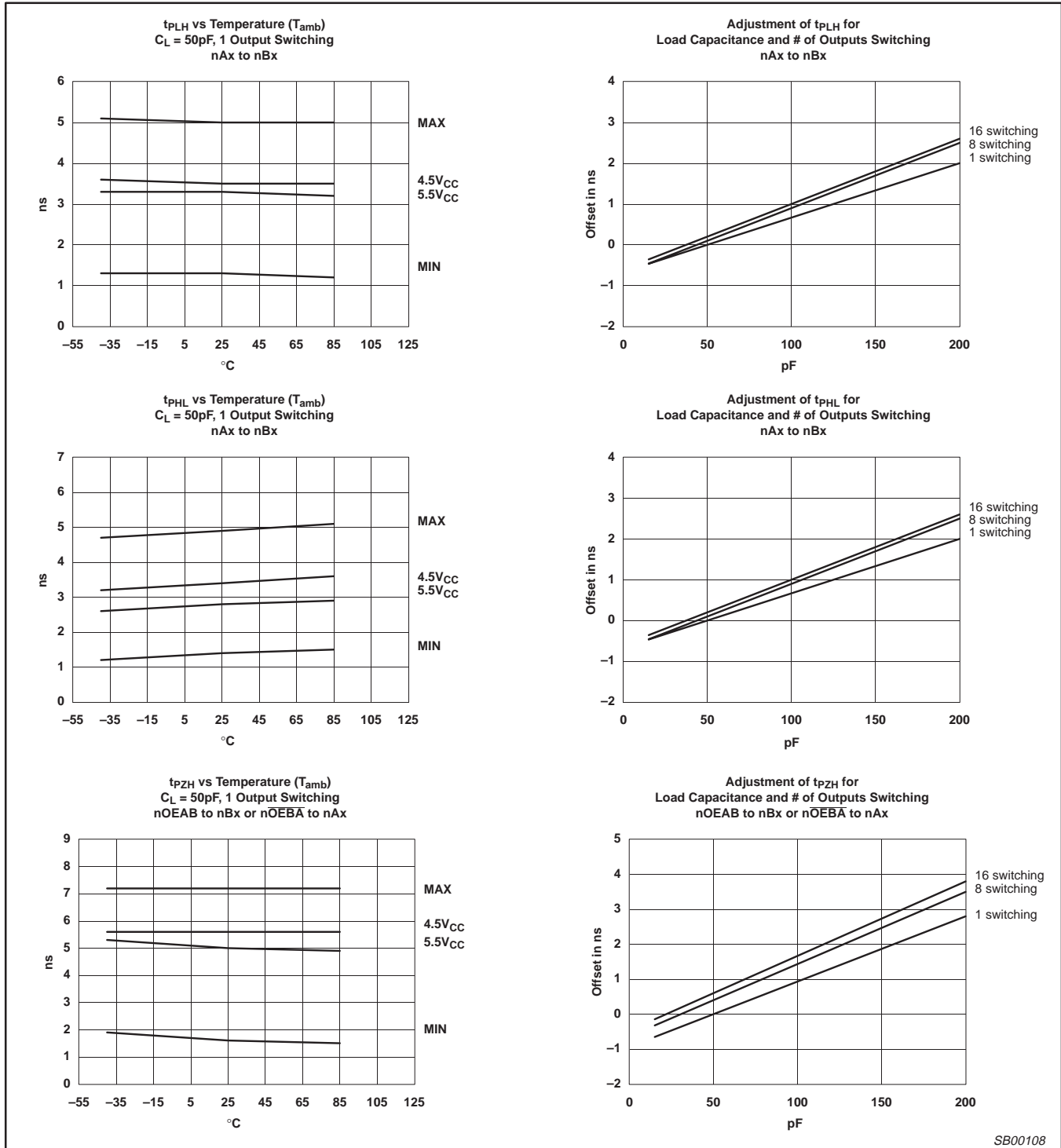

# 16-bit transceiver with dual enable, non-inverting (3-State)

MB2623

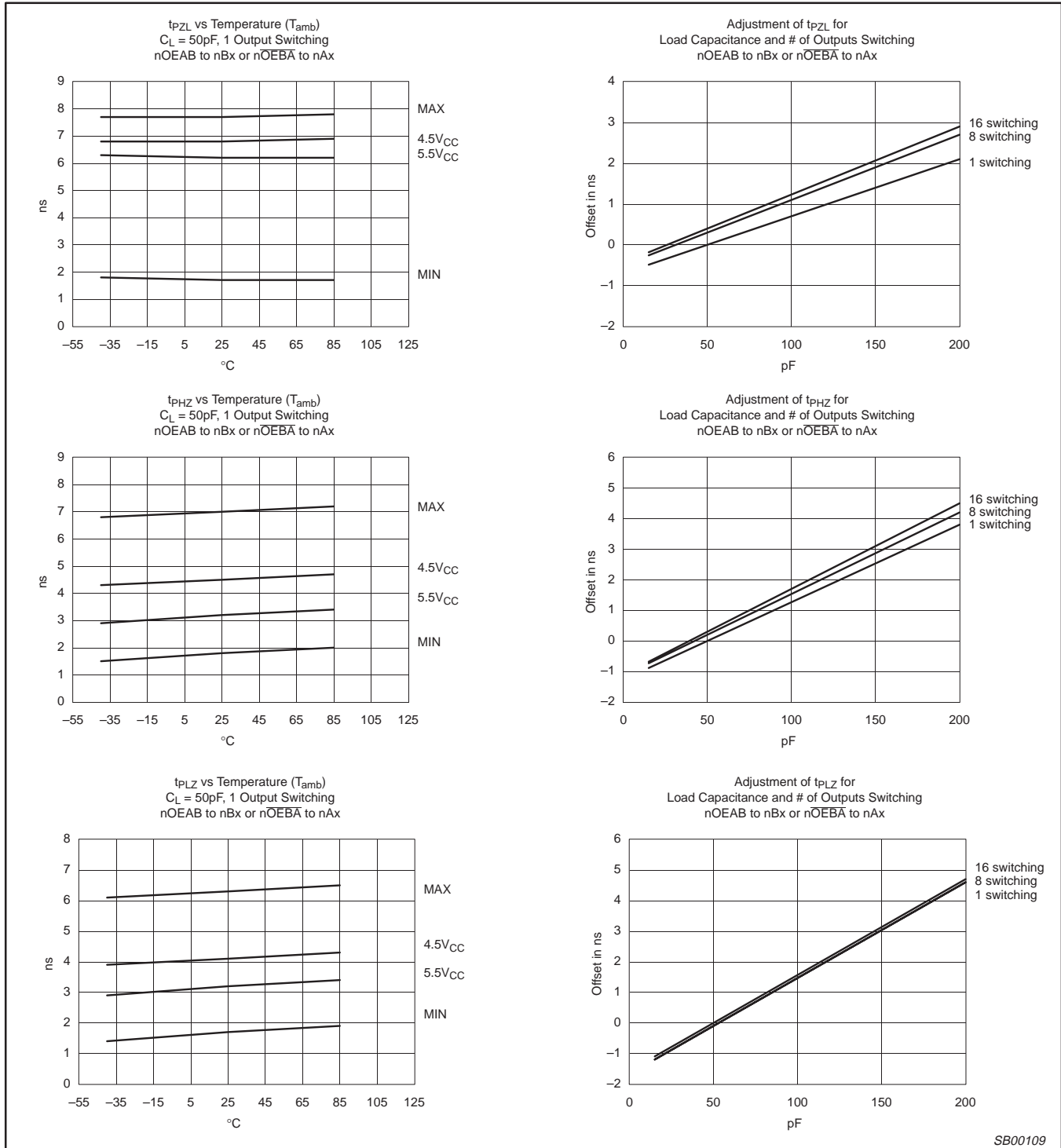

SB00109



# 16-bit transceiver with dual enable, non-inverting (3-State)

MB2623

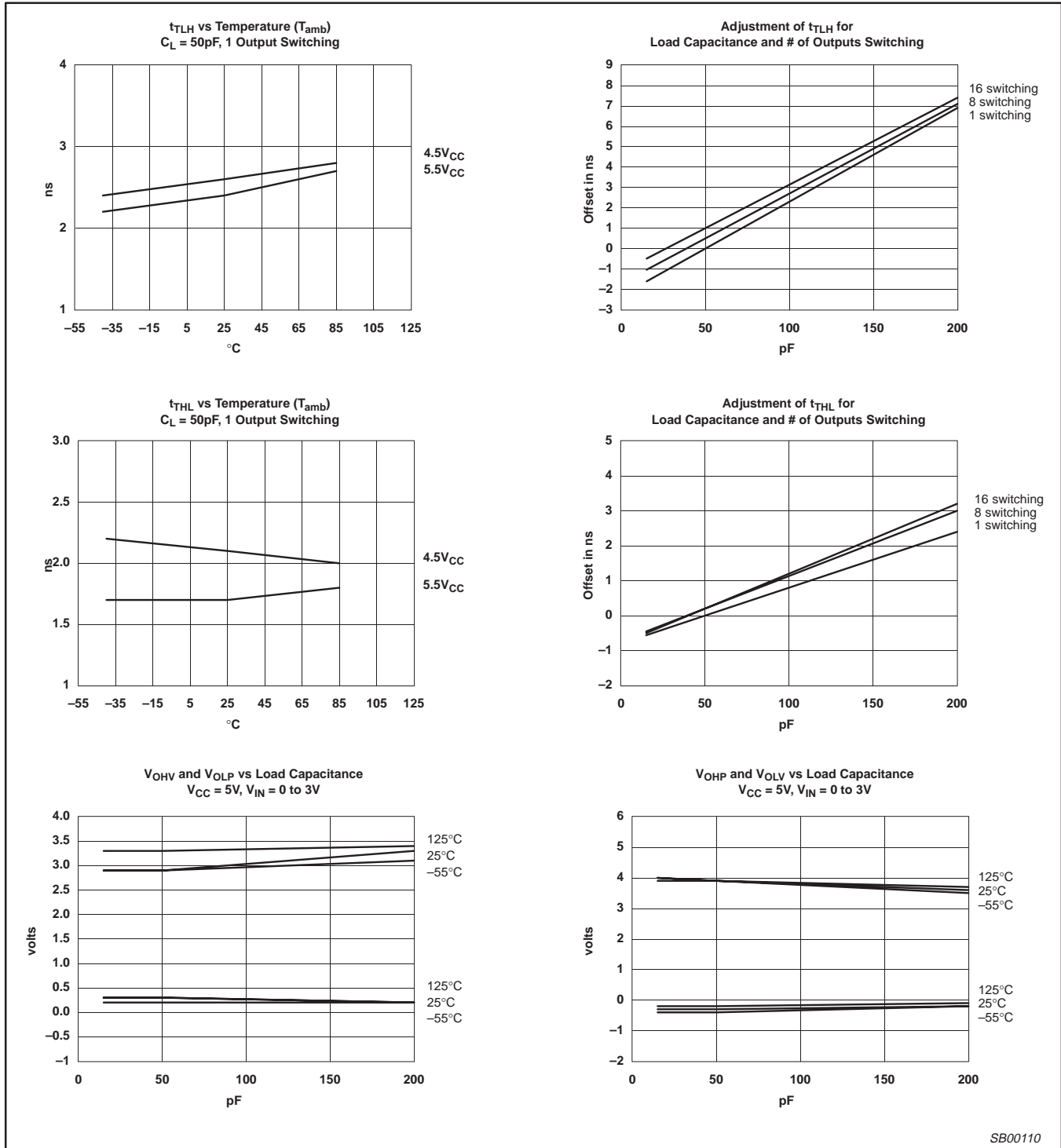

SB00110

# 16-bit transceiver with dual enable, non-inverting (3-State)

MB2623

**QFP52: plastic quad flat package; 52 leads (lead length 1.6 mm); body 10 x 10 x 2.0 mm**

**SOT379-1**

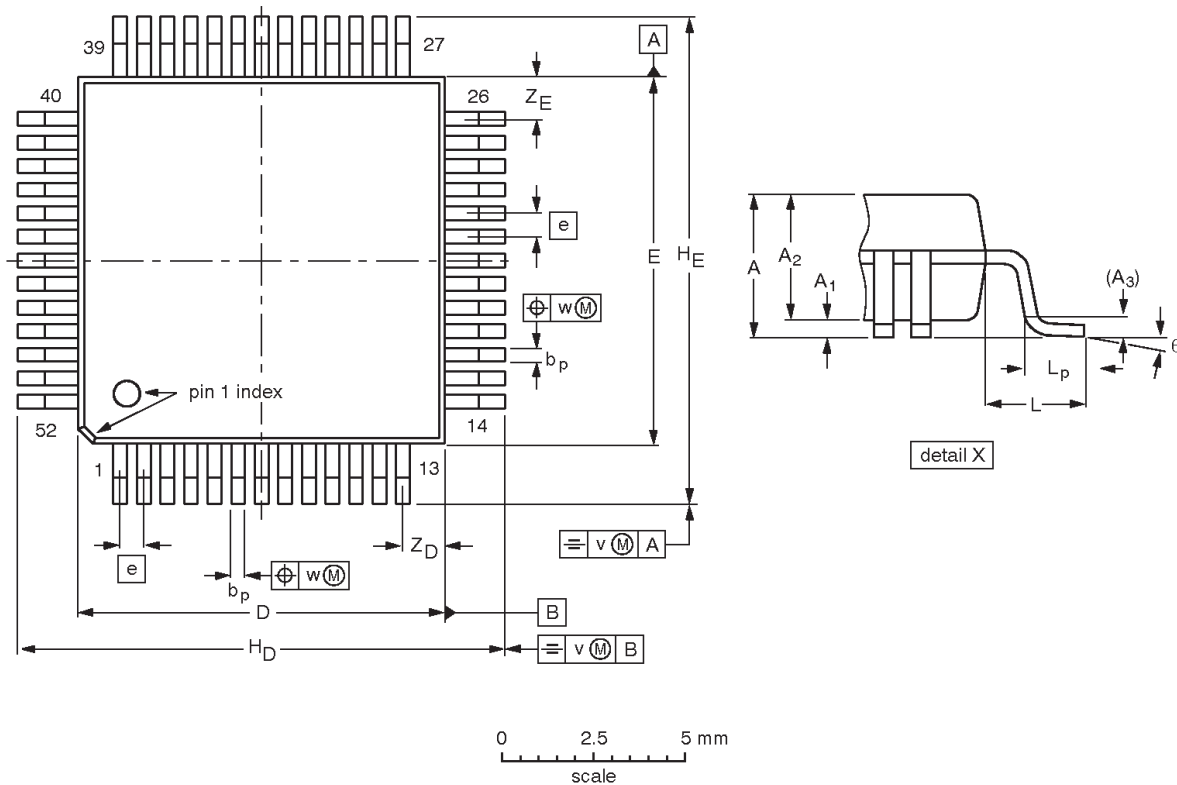
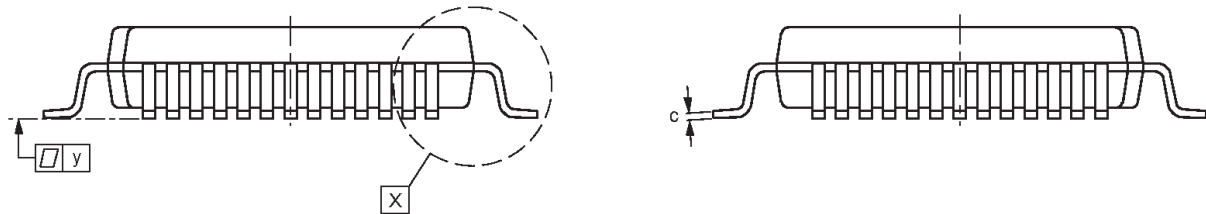

**DIMENSIONS (mm are the original dimensions)**

UNIT	A max.	A <sub>1</sub>	A <sub>2</sub>	A <sub>3</sub>	b <sub>p</sub>	c	D <sup>(1)</sup>	E <sup>(1)</sup>	e	H <sub>D</sub>	H <sub>E</sub>	L	L <sub>p</sub>	v	w	y	Z <sub>D</sub> <sup>(1)</sup>	Z <sub>E</sub> <sup>(1)</sup>	θ
mm	2.45	0.45 0.25	2.10 1.95	0.25	0.38 0.22	0.23 0.13	10.1 9.9	10.1 9.9	0.65	13.45 12.95	13.45 12.95	1.60	0.95 0.65	0.20	0.12	0.10	1.24 0.95	1.24 0.95	7° 0°

**Note**

1. Plastic or metal protrusions of 0.25 mm maximum per side are not included.

OUTLINE VERSION	REFERENCES			EUROPEAN PROJECTION	ISSUE DATE
	IEC	JEDEC	EIAJ		
SOT379-1		MO-108			95-02-04 97-08-04

---

**16-bit transceiver with dual enable, non-inverting  
(3-State)**

---

**MB2623**

**NOTES**

# 16-bit transceiver with dual enable, non-inverting (3-State)

MB2623

## Data sheet status

Data sheet status	Product status	Definition [1]
Objective specification	Development	This data sheet contains the design target or goal specifications for product development. Specification may change in any manner without notice.
Preliminary specification	Qualification	This data sheet contains preliminary data, and supplementary data will be published at a later date. Philips Semiconductors reserves the right to make changes at any time without notice in order to improve design and supply the best possible product.
Product specification	Production	This data sheet contains final specifications. Philips Semiconductors reserves the right to make changes at any time without notice in order to improve design and supply the best possible product.

[1] Please consult the most recently issued datasheet before initiating or completing a design.

## Definitions

**Short-form specification** — The data in a short-form specification is extracted from a full data sheet with the same type number and title. For detailed information see the relevant data sheet or data handbook.

**Limiting values definition** — Limiting values given are in accordance with the Absolute Maximum Rating System (IEC 134). Stress above one or more of the limiting values may cause permanent damage to the device. These are stress ratings only and operation of the device at these or at any other conditions above those given in the Characteristics sections of the specification is not implied. Exposure to limiting values for extended periods may affect device reliability.

**Application information** — Applications that are described herein for any of these products are for illustrative purposes only. Philips Semiconductors make no representation or warranty that such applications will be suitable for the specified use without further testing or modification.

## Disclaimers

**Life support** — These products are not designed for use in life support appliances, devices or systems where malfunction of these products can reasonably be expected to result in personal injury. Philips Semiconductors customers using or selling these products for use in such applications do so at their own risk and agree to fully indemnify Philips Semiconductors for any damages resulting from such application.

**Right to make changes** — Philips Semiconductors reserves the right to make changes, without notice, in the products, including circuits, standard cells, and/or software, described or contained herein in order to improve design and/or performance. Philips Semiconductors assumes no responsibility or liability for the use of any of these products, conveys no license or title under any patent, copyright, or mask work right to these products, and makes no representations or warranties that these products are free from patent, copyright, or mask work right infringement, unless otherwise specified.

Philips Semiconductors  
811 East Arques Avenue  
P.O. Box 3409  
Sunnyvale, California 94088-3409  
Telephone 800-234-7381

© Copyright Philips Electronics North America Corporation 1998  
All rights reserved. Printed in U.S.A.

print code

Date of release: 05-96

Document order number:

9397-750-03513

*Let's make things better.*