

TLG2177, TLG4172, TLG2207, TLG4202

GREEN COLOR 4 DIGITS LED DISPLAY

- For use of Static drive connections and available both polarity common anode or common cathode.
- 15 mm (0.6") character height, each segment is diffused and uniformly display.
- Outer color filter provides high contrast, complete practical use at 10 mA per segments.
- Arrow edge shape of each segment represents not mosaic but look like Arabic numerals.
- Selectable both type 12 or 24 hours of display.

TYPE NO. VS. DISPLAY FONT

COMMON ANODE	COMMON CATHODE	FULLY DISPLAY FONT
TLG2177	TLG2207	: 10 : 00
TLG4172	TLG4202	: 00 : 00

MAXIMUM RATINGS (Ta = 25 °C)

CHARACTERISTIC	SYMBOL	RATING	UNIT
Forward Current/Seg.	If(DC)/Seg.	15	mA
Reverse Voltage	VR	3	V
Storage Temperature Range	Tstg	-20~75	°C
Operating Temperature Range	Topr	-20~60	°C
Soldering Temperature (Note)	Tsolder	260	°C

Note: Within 3 second at 2 mm from the reflector edge.

ELECTRICAL-OPTICAL CHARACTERISTICS (Ta = 25 °C)

CHARACTERISTIC	SYMBOL	TEST CONDITION	MIN.	TYP.	MAX.	UNIT
Forward Voltage	Vf	If=10mA	1.8	2.0	2.5	V
Reverse Current	IR	VR=3V	-	-	5	µA
Luminous Intensity/Seg.	Iv/Seg.	If=10mA	0.08	0.3	-	med
Luminous Intensity Matching Ratio	Iv-M	If=5mA	-	-	2.3	-
Peak Emission Wave Length	λp	If=10mA	-	565	-	nm
Spectral Half Line Width	Δλ	If=10mA	-	30	-	nm

Refer to page 257 for the figure.

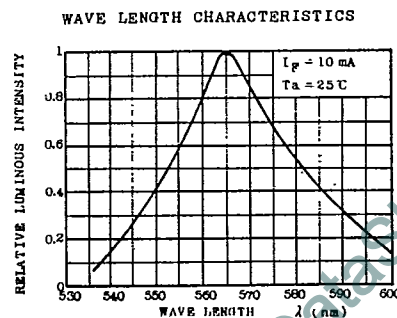
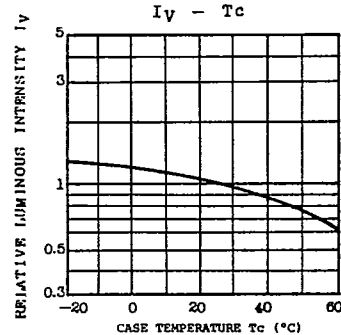
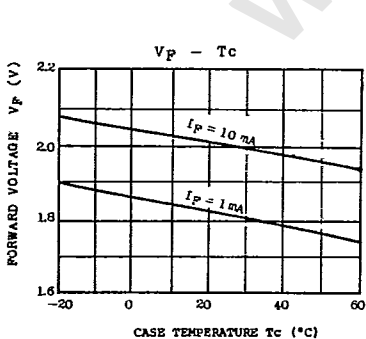
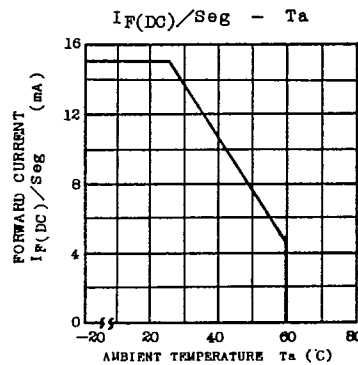
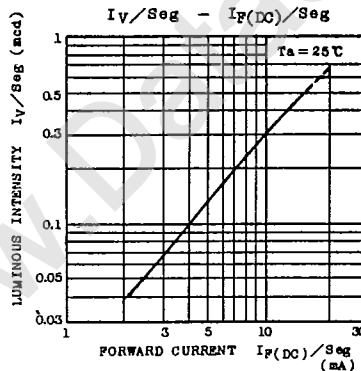
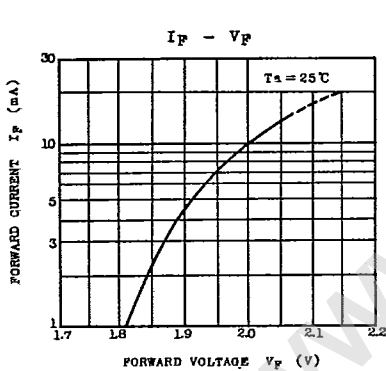

PHYSICAL DIMENSIONS

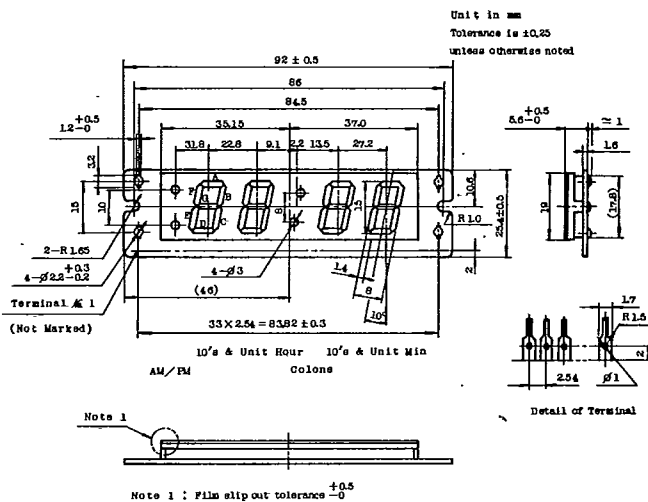

TERMINAL CONNECTION (○: CONNECTION, ×: NO CONNECTION)

TERMINAL #	CONNECTION	TLG2177 TLG2107 TLR2107	TLG4172 TLG4102 TLR4102	TERMINAL #	CONNECTION	TLG2177 TLG2107 TLR2107	TLG4172 TLG4102 TLR4102
1	Common			18	Upper Colon	○	○
2	PM	○	○	19	Lower Colon	○	○
3	AM	○	○	20	10's Min. F	○	○
4	10's Hour A	×	○	21	10's Min. G	○	○
5	10's Hour F	×	○	22	10's Min. A	○	○
6	10's Hour G	×	○	23	10's Min. B	○	○
7	10's Hour E	×	○	24	10's Min. D	○	○
8	10's Hour D	×	○	25	10's Min. E	○	○
9	10's Hour C	○	○	26	10's Min. C	○	○
10	10's Hour B	○	○	27	Unit Min. F	○	○
11	Unit Hour F	○	○	28	Unit Min. G	○	○
12	Unit Hour G	○	○	29	Unit Min. A	○	○
13	Unit Hour A	○	○	30	Unit Min. B	○	○
14	Unit Hour B	○	○	31	Unit Min. E	○	○
15	Unit Hour E	○	○	32	Unit Min. D	○	○
16	Unit Hour D	○	○	33	Unit Min. C	○	○
17	Unit Hour C	○	○	34	Common		

TLG2177/TLR2177, TIG4172/TLR4172 COMMON ANODE TYPE

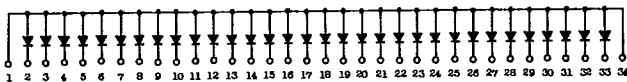

TLG2207/TLR2207, TIG4202/TLR4202 COMMON CATHODE TYPE

