

Medium power transistor (–60V, –0.5A)

2SA2089S

●Features

- 1) High speed switching.
(Tf : Typ. : 60ns at $I_c = -500\text{mA}$)
- 2) Low saturation voltage, typically
(Typ. : -150mV at $I_c = -100\text{mA}$, $I_B = -10\text{mA}$)
- 3) Strong discharge power for inductive load and capacitance load.
- 4) Complements the 2SC5877S

●Applications

Small signal low frequency amplifier
High speed switching

●Structure

PNP Silicon epitaxial planar transistor

●Packaging specifications

Type	Package	Taping
	Code	TP
	Basic ordering unit (pieces)	5000
2SA2089S		○

●Absolute maximum ratings (Ta=25°C)

Parameter		Symbol	Limits	Unit
Collector-base voltage		V_{CBO}	–60	V
Collector-emitter voltage		V_{CEO}	–60	V
Emitter-base voltage		V_{EBO}	–6	V
Collector current	DC	I_c	–0.5	A
	Pulsed	I_{cP}	–1.0	A *
Power dissipation		P_c	300	mW
Junction temperature		T_j	150	°C
Range of storage temperature		T_{stg}	–55 to 150	°C

*Pw=10ms

●External dimensions (Unit : mm)

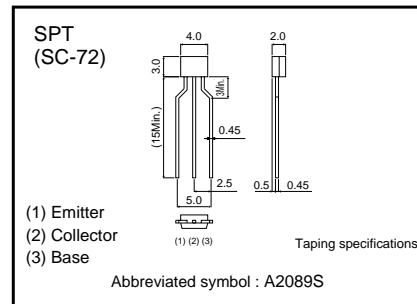

Transistors

●Electrical characteristics (Ta=25°C)

Parameter	Symbol	Min.	Typ.	Max.	Unit	Condition
Collector-emitter breakdown voltage	BV_{CEO}	-60	-	-	V	$I_C = -1\text{mA}$
Collector-base breakdown voltage	BV_{CBO}	-60	-	-	V	$I_C = -100\mu\text{A}$
Emitter-base breakdown voltage	BV_{EBO}	-6	-	-	V	$I_E = -100\mu\text{A}$
Collector cut-off current	I_{CBO}	-	-	-1.0	μA	$V_{CB} = -40\text{V}$
Emitter cut-off current	I_{EBO}	-	-	-1.0	μA	$V_{EB} = -4\text{V}$
Collector-emitter saturation voltage	$V_{CE(sat)}$	-	-150	-300	mV	$I_C = -100\text{mA}$ $I_B = -10\text{mA}$
DC current gain	h_{FE}	120	-	270	-	$V_{CE} = -2\text{V}$ $I_C = -50\text{mA}$
Transition frequency	f_T	-	400	-	MHz	$V_{CE} = -10\text{V}$ $I_E = 100\text{mA}$ $f = 10\text{MHz}$
Corrector output capacitance	C_{ob}	-	10	-	pF	$V_{CB} = -10\text{V}$ $I_E = 0\text{mA}$ $f = 1\text{MHz}$
Turn-on time	T_{on}	-	35	-	ns	$I_C = -500\text{mA}$ $I_{B1} = -50\text{mA}$ $I_{B2} = 50\text{mA}$
Storage time	T_{stg}	-	100	-	ns	$V_{CC} = -25\text{V}$
Fall time	T_f	-	60	-	ns	

*1 Non repetitive pulse

*2 See Switching characteristics measurement circuits

● h_{FE} RANK

Q
120-270

●Electrical characteristic curves

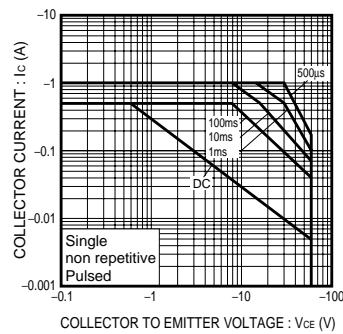

Fig.1 Safe Operating Area

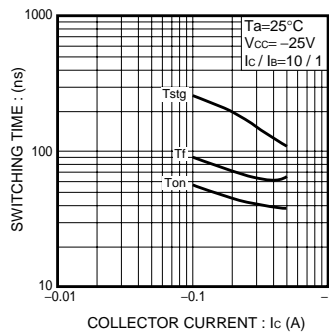

Fig.2 Switching Time

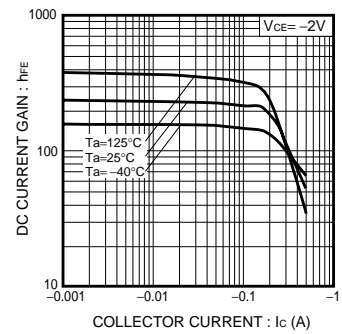

Fig.3 DC Current Gain vs. Collector Current (I)

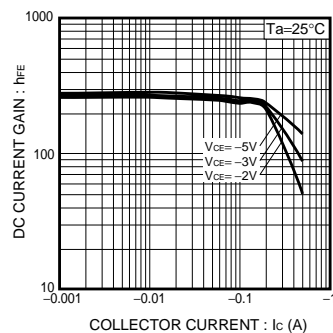

Fig.4 DC Current Gain vs. Collector Current (II)

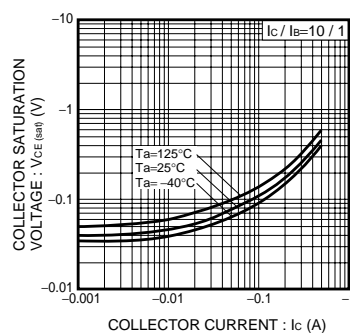

Fig.5 Collector-Emitter Saturation Voltage vs. Collector Current (I)

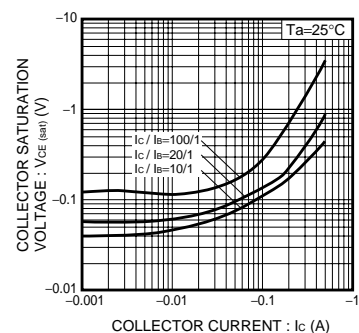

Fig.6 Collector-Emitter Saturation Voltage vs. Collector Current (II)

Transistors

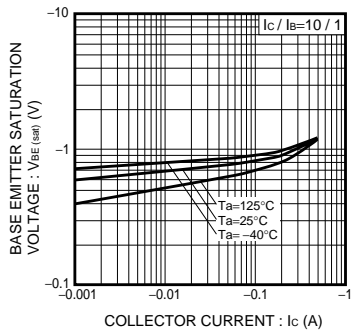

Fig.7 Base-Emitter Saturation Voltage vs. Collector Current

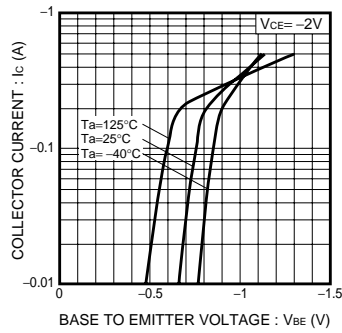

Fig.8 Grounded Emitter Propagation Characteristics

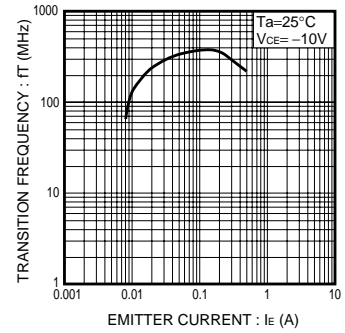

Fig.9 Transition Frequency

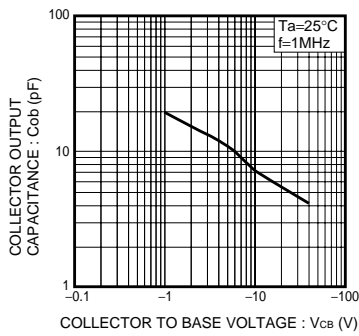
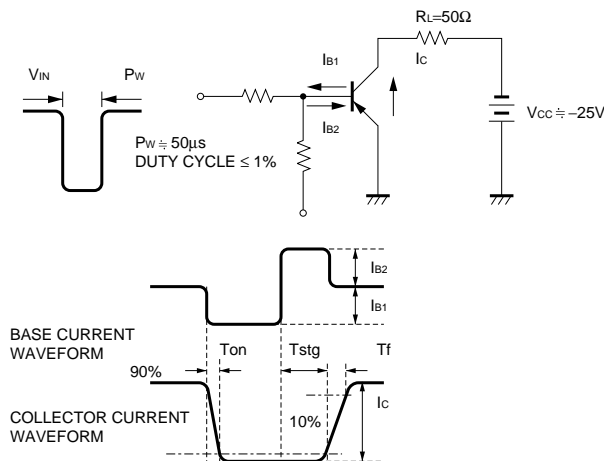

Fig.10 Collector Output Capacitance

●Switching characteristics measurement circuits



Notes

- No technical content pages of this document may be reproduced in any form or transmitted by any means without prior permission of ROHM CO.,LTD.
- The contents described herein are subject to change without notice. The specifications for the product described in this document are for reference only. Upon actual use, therefore, please request that specifications to be separately delivered.
- Application circuit diagrams and circuit constants contained herein are shown as examples of standard use and operation. Please pay careful attention to the peripheral conditions when designing circuits and deciding upon circuit constants in the set.
- Any data, including, but not limited to application circuit diagrams information, described herein are intended only as illustrations of such devices and not as the specifications for such devices. ROHM CO.,LTD. disclaims any warranty that any use of such devices shall be free from infringement of any third party's intellectual property rights or other proprietary rights, and further, assumes no liability of whatsoever nature in the event of any such infringement, or arising from or connected with or related to the use of such devices.
- Upon the sale of any such devices, other than for buyer's right to use such devices itself, resell or otherwise dispose of the same, no express or implied right or license to practice or commercially exploit any intellectual property rights or other proprietary rights owned or controlled by
- ROHM CO., LTD. is granted to any such buyer.
- Products listed in this document use silicon as a basic material.
Products listed in this document are no antiradiation design.

The products listed in this document are designed to be used with ordinary electronic equipment or devices (such as audio visual equipment, office-automation equipment, communications devices, electrical appliances and electronic toys).

Should you intend to use these products with equipment or devices which require an extremely high level of reliability and the malfunction of which would directly endanger human life (such as medical instruments, transportation equipment, aerospace machinery, nuclear-reactor controllers, fuel controllers and other safety devices), please be sure to consult with our sales representative in advance.

About Export Control Order in Japan

Products described herein are the objects of controlled goods in Annex 1 (Item 16) of Export Trade Control Order in Japan.

In case of export from Japan, please confirm if it applies to "objective" criteria or an "informed" (by MITI clause) on the basis of "catch all controls for Non-Proliferation of Weapons of Mass Destruction.