

TRIACS

Silicon Bidirectional Thyristors

Designed for high volume, low cost, industrial and consumer applications such as motor control; process control; temperature, light and speed control.

- Small Size Surface Mount DPAK Package
- Passivated Die for Reliability and Uniformity
- Blocking Voltage to 800 V
- On-State Current Rating of 4.0 Amperes RMS at 108°C
- Low IGT — 10 mA Maximum in 3 Quadrants
- High Immunity to dv/dt — 50 V/μs at 125°C

ORDERING INFORMATION

- To Obtain "DPAK" in Surface Mount Leadform (Case 369A)
Shipped in 16 mm Tape and Reel — Add "T4" Suffix to Device Number, i.e. MAC4DSNT4
- To Obtain "DPAK" in Straight Lead Version (Case 369) Shipped in Sleeves — Add "-1" Suffix to Device Number, i.e. MAC4DSN-1

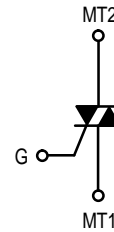

MAC4DSM
MAC4DSN

Motorola Preferred Devices

TRIACS
4.0 AMPERES RMS
600 thru 800 VOLTS

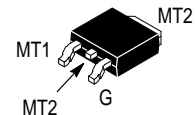

CASE 369A-13
STYLE 6

MAXIMUM RATINGS (T_J = 25°C unless otherwise noted)

Rating	Symbol	Value	Unit
Peak Repetitive Off-State Voltage ⁽¹⁾ (T _J = -40 to 125°C, Sine Wave, 50 to 60 Hz, Gate Open)	V _{DRM}	600 800	Volts
On-State RMS Current (Full Cycle Sine Wave, 60 Hz, T _C = 108°C)	I _{T(RMS)}	4.0	Amps
Peak Non-Repetitive Surge Current (One Full Cycle, 60 Hz, T _J = 125°C)	I _{TSM}	40	
Circuit Fusing Consideration (t = 8.3 msec)	I ² t	6.6	A ² sec
Peak Gate Power (Pulse Width ≤ 10 μsec, T _C = 108°C)	P _{GM}	0.5	Watts
Average Gate Power (t = 8.3 msec, T _C = 108°C)	P _{G(AV)}	0.1	
Peak Gate Current (Pulse Width ≤ 10 μsec, T _C = 108°C)	I _{GM}	0.2	Amps
Peak Gate Voltage (Pulse Width ≤ 10 μsec, T _C = 108°C)	V _{GM}	5.0	Volts
Operating Junction Temperature Range	T _J	-40 to 125	°C
Storage Temperature Range	T _{stg}	-40 to 150	

THERMAL CHARACTERISTICS

Characteristic	Symbol	Max	Unit
Thermal Resistance — Junction to Case	R _{θJC}	3.5	°C/W
— Junction to Ambient	R _{θJA}	88	
— Junction to Ambient ⁽²⁾	R _{θJA}	80	
Maximum Lead Temperature for Soldering Purposes ⁽³⁾	T _L	260	°C

(1) V_{DRM} for all types can be applied on a continuous basis. Ratings apply for zero or negative gate voltage; positive gate voltage shall not be applied concurrent with negative potential on the anode. Blocking voltages shall not be tested with a constant current source such that the voltage ratings of the device are exceeded.

(2) Surface mounted on minimum recommended pad size.

(3) 1/8" from case for 10 seconds.

Preferred devices are Motorola recommended choices for future use and best overall value.

REV 1

MAC4DSM MAC4DSN

ELECTRICAL CHARACTERISTICS (T_J = 25°C unless otherwise noted)

Characteristics	Symbol	Min	Typ	Max	Unit
Peak Repetitive Blocking Current (V _D = Rated V _{DRM} , Gate Open) T _J = 25°C T _J = 125°C	I _{DRM}	— —	— —	0.01 2.0	mA
Peak On-State Voltage (1) (I _{TM} = ±6.0 A)	V _{TM}	—	1.3	1.6	Volts
Gate Trigger Current (Continuous dc) (V _D = 12 V, R _L = 100 Ω) MT2(+), G(+) MT2(+), G(-) MT2(-), G(-)	I _{GT}	2.9 2.9 2.9	4.0 5.0 7.0	10 10 10	mA
Gate Trigger Voltage (Continuous dc) (V _D = 12 V, R _L = 100 Ω) MT2(+), G(+) MT2(+), G(-) MT2(-), G(-) MT2(+), G(+); MT2(+), G(-); MT2(-), G(-) T _J = 125°C	V _{GT}	0.5 0.5 0.5 0.2	0.7 0.65 0.7 0.4	1.3 1.3 1.3 —	Volts
Holding Current (V _D = 12 V, Gate Open, I _T = ±200 mA)	I _H	2.0	5.5	15	mA
Latching Current (V _D = 12 V, I _G = 10 mA) MT2(+), G(+) MT2(+), G(-) MT2(-), G(-)	I _L	— — —	6.0 10 6.0	30 30 30	mA

DYNAMIC CHARACTERISTICS

Characteristics	Symbol	Min	Typ	Max	Unit
Rate of Change of Commutating Current (1) (V _D = 400 V, I _{TM} = 3.5 A, Commutating dv/dt = 10 V/μsec, Gate Open, T _J = 125°C, f = 500 Hz, CL = 5.0 μF, LL = 20 mH, No Snubber) See Figure 15	di/dt(c)	3.0	4.0	—	A/ms
Critical Rate of Rise of Off-State Voltage (V _D = 0.67 X Rated V _{DRM} , Exponential Waveform, Gate Open, T _J = 125°C)	dv/dt	50	175	—	V/μs

(1) Pulse test: Pulse Width ≤ 2.0 msec, Duty Cycle ≤ 2%.

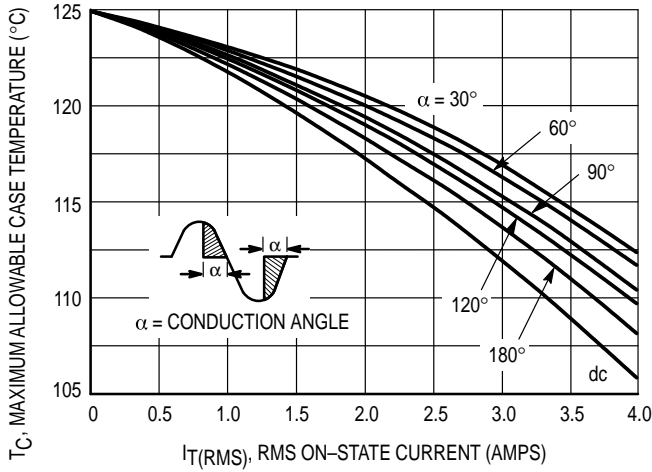

Figure 1. RMS Current Derating

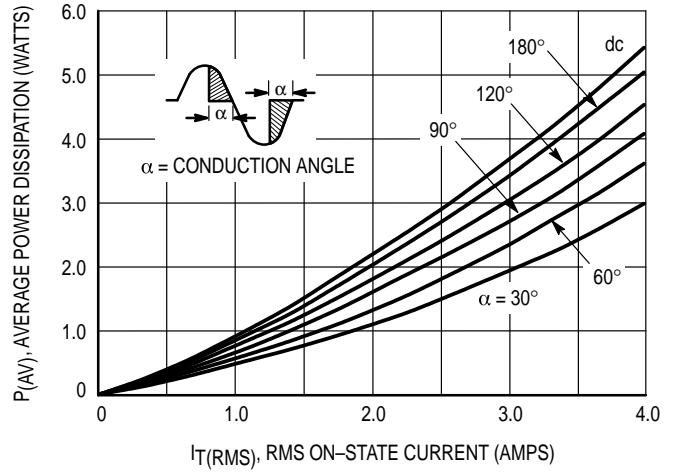

Figure 2. On-State Power Dissipation

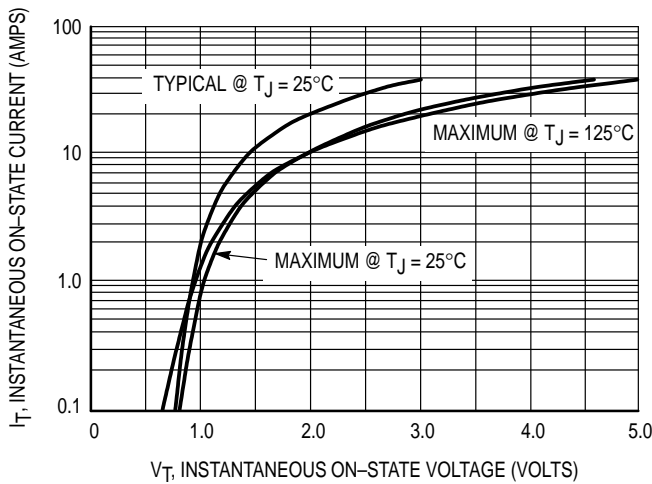

Figure 3. On-State Characteristics

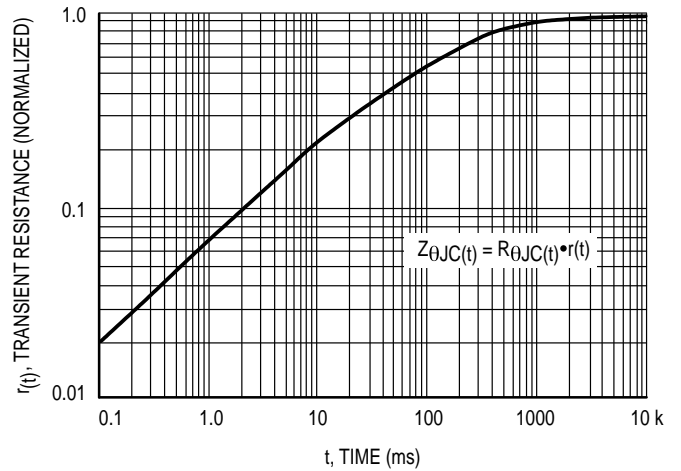

Figure 4. Transient Thermal Response

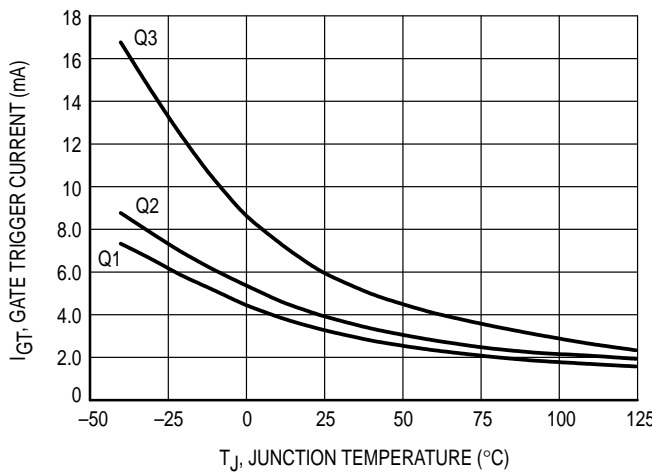

Figure 5. Typical Gate Trigger Current versus Junction Temperature

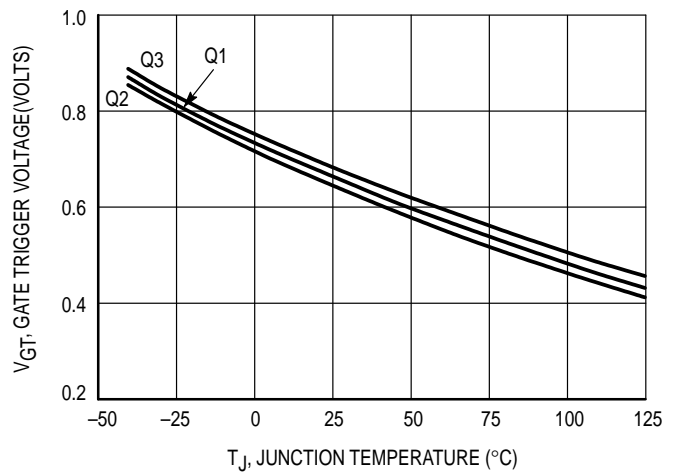

Figure 6. Typical Gate Trigger Voltage versus Junction Temperature

MAC4DSM MAC4DSN

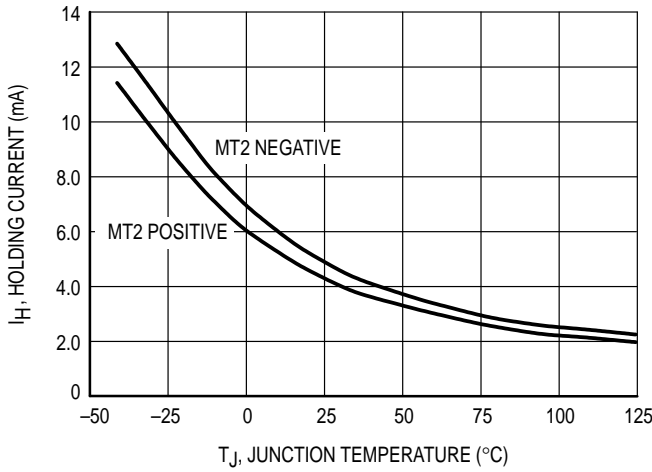

Figure 7. Typical Holding Current versus Junction Temperature

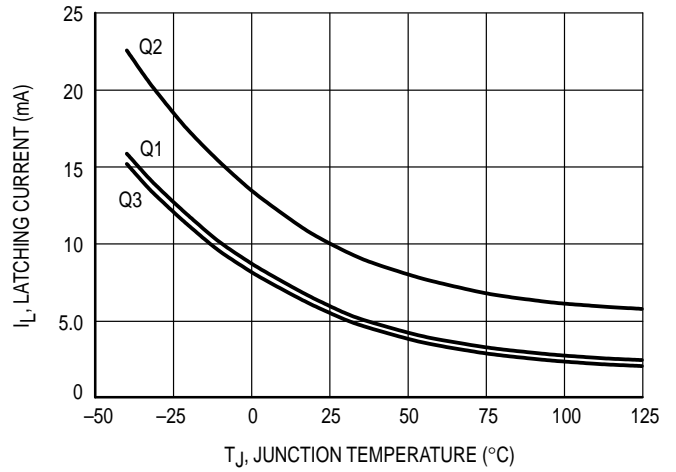

Figure 8. Typical Latching Current versus Junction Temperature

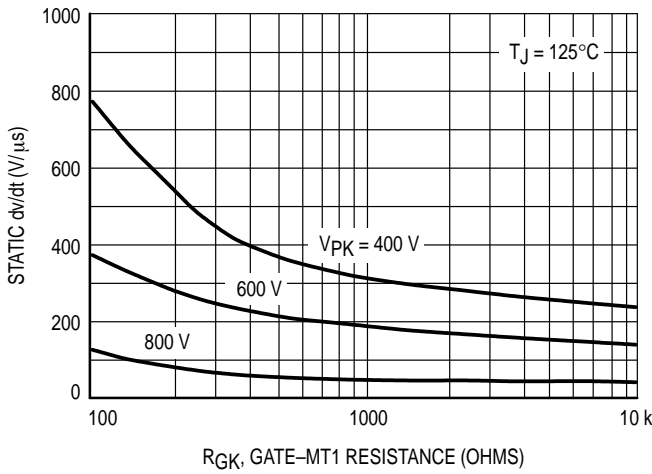

Figure 9. Exponential Static dv/dt versus Gate-MT1 Resistance, MT2(+)

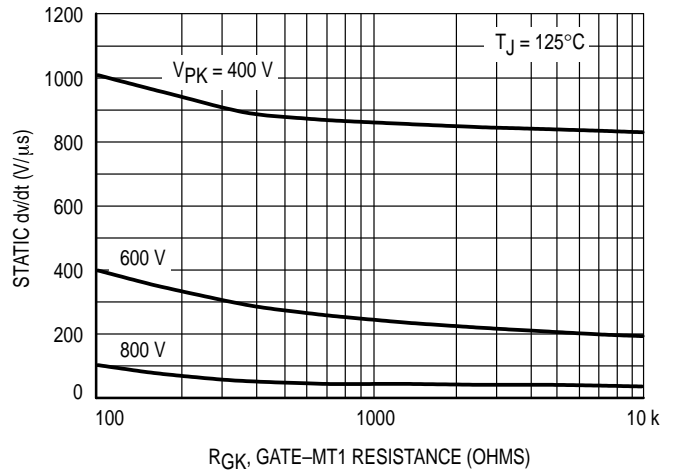

Figure 10. Exponential Static dv/dt versus Gate-MT1 Resistance, MT2(-)

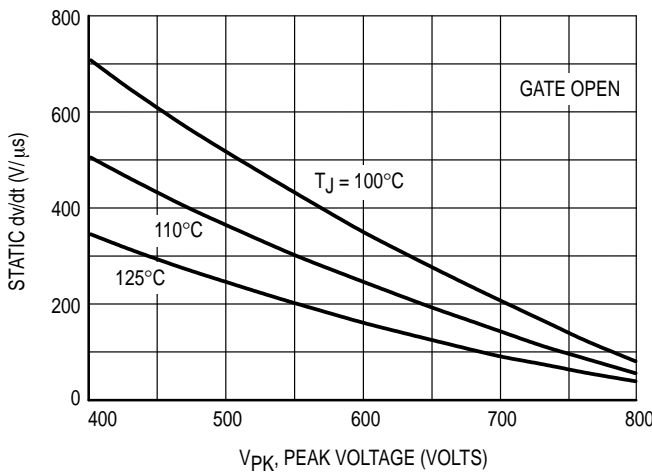

Figure 11. Exponential Static dv/dt versus Peak Voltage, MT2(+)

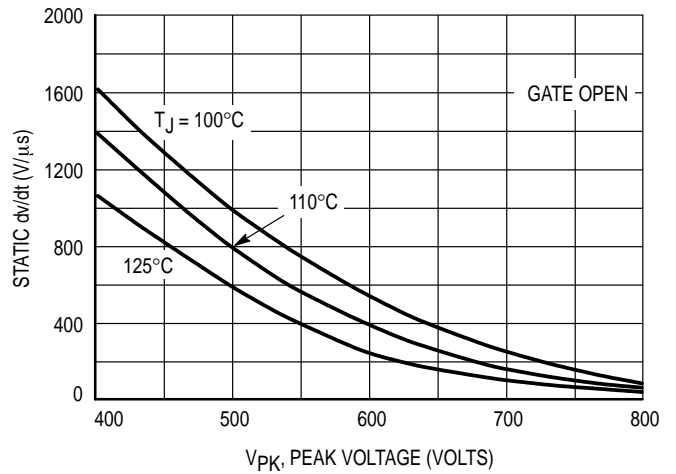

Figure 12. Exponential Static dv/dt versus Peak Voltage, MT2(-)

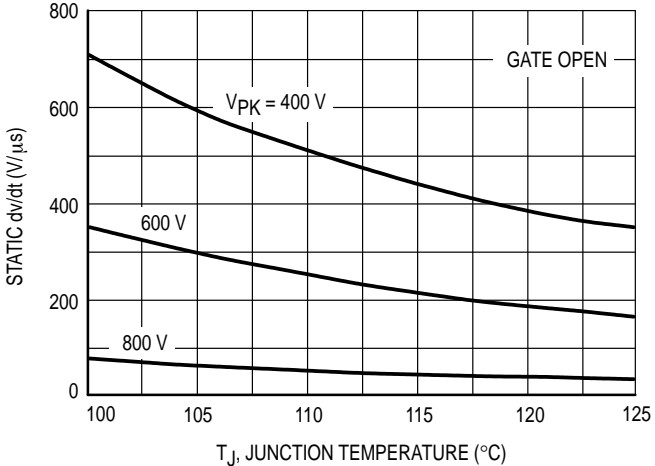

Figure 13. Typical Exponential Static dv/dt versus Junction Temperature, MT2(+)

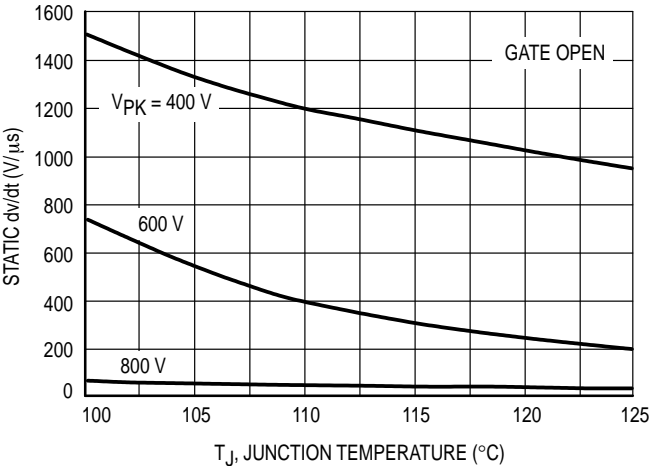

Figure 14. Typical Exponential Static dv/dt versus Junction Temperature, MT2(-)

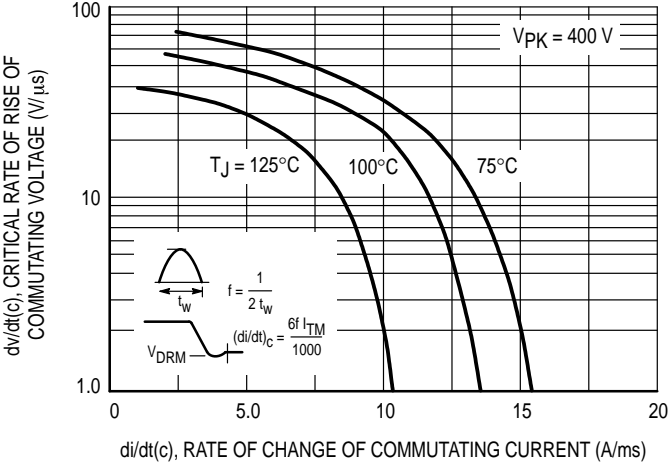

Figure 15. Critical Rate of Rise of Commutating Voltage

MAC4DSM MAC4DSN

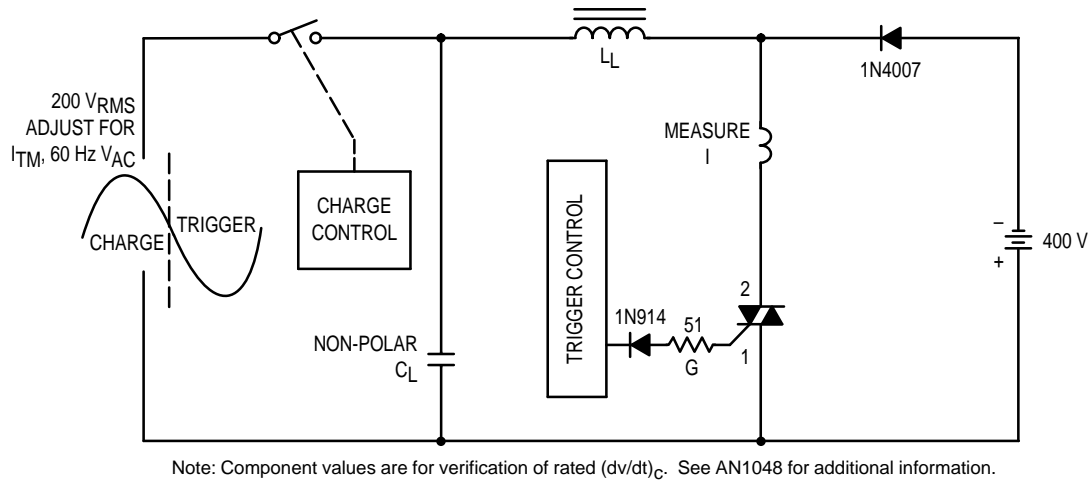
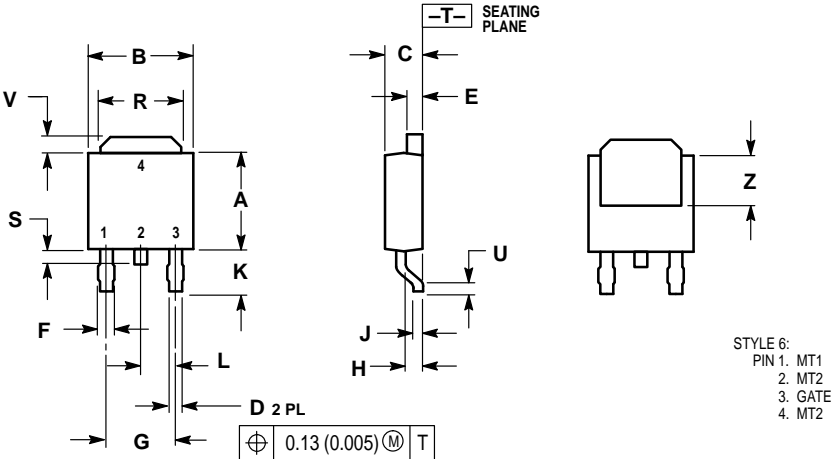

Figure 16. Simplified Test Circuit to Measure the Critical Rate of Rise of Commutating Voltage

PACKAGE DIMENSIONS



- NOTES:
 1. DIMENSIONING AND TOLERANCING PER ANSI Y14.5M, 1982.
 2. CONTROLLING DIMENSION: INCH.

DIM	INCHES		MILLIMETERS	
	MIN	MAX	MIN	MAX
A	0.235	0.250	5.97	6.35
B	0.250	0.265	6.35	6.73
C	0.086	0.094	2.19	2.38
D	0.027	0.035	0.69	0.88
E	0.033	0.040	0.84	1.01
F	0.037	0.047	0.94	1.19
G	0.180 BSC		4.58 BSC	
H	0.034	0.040	0.87	1.01
J	0.018	0.023	0.46	0.58
K	0.102	0.114	2.60	2.89
L	0.090 BSC		2.29 BSC	
R	0.175	0.215	4.45	5.46
S	0.020	0.050	0.51	1.27
U	0.020	—	0.51	—
V	0.030	0.050	0.77	1.27
Z	0.138	—	3.51	—

CASE 369A-13
 ISSUE Z

MAC4DSM MAC4DSN

Motorola reserves the right to make changes without further notice to any products herein. Motorola makes no warranty, representation or guarantee regarding the suitability of its products for any particular purpose, nor does Motorola assume any liability arising out of the application or use of any product or circuit, and specifically disclaims any and all liability, including without limitation consequential or incidental damages. "Typical" parameters which may be provided in Motorola data sheets and/or specifications can and do vary in different applications and actual performance may vary over time. All operating parameters, including "Typicals" must be validated for each customer application by customer's technical experts. Motorola does not convey any license under its patent rights nor the rights of others. Motorola products are not designed, intended, or authorized for use as components in systems intended for surgical implant into the body, or other applications intended to support or sustain life, or for any other application in which the failure of the Motorola product could create a situation where personal injury or death may occur. Should Buyer purchase or use Motorola products for any such unintended or unauthorized application, Buyer shall indemnify and hold Motorola and its officers, employees, subsidiaries, affiliates, and distributors harmless against all claims, costs, damages, and expenses, and reasonable attorney fees arising out of, directly or indirectly, any claim of personal injury or death associated with such unintended or unauthorized use, even if such claim alleges that Motorola was negligent regarding the design or manufacture of the part. Motorola and  are registered trademarks of Motorola, Inc. Motorola, Inc. is an Equal Opportunity/Affirmative Action Employer.

Mfax is a trademark of Motorola, Inc.

How to reach us:

USA/EUROPE/Locations Not Listed: Motorola Literature Distribution;
P.O. Box 5405, Denver, Colorado 80217. 1-303-675-2140 or 1-800-441-2447

JAPAN: Motorola Japan Ltd.; SPD, Strategic Planning Office, 141,
4-32-1 Nishi-Gotanda, Shinagawa-ku, Tokyo, Japan. 81-3-5487-8488

Customer Focus Center: 1-800-521-6274

Mfax™: RMFAX0@email.sps.mot.com – TOUCHTONE 1-602-244-6609
Motorola Fax Back System – US & Canada ONLY 1-800-774-1848
– <http://sps.motorola.com/mfax/>

ASIA/PACIFIC: Motorola Semiconductors H.K. Ltd.; Silicon Harbour Centre,
2, Dai King Street, Tai Po Industrial Estate, Tai Po, N.T., Hong Kong.
852-26629298

HOME PAGE: <http://motorola.com/sps/>



MOTOROLA



MAC4DSM/D