

NPN SiGe RF TRANSISTOR

Application

LNA and wide band amplifier up to GHz range

Features

o Low Noise Figure

NF = 1.5 dB Typ. @ f = 2 GHz, $V_{CE} = 3\text{ V}$, $I_C = 5\text{ mA}$

NF = 1.7 dB Typ. @ f = 2 GHz, $V_{CE} = 1\text{ V}$, $I_C = 3\text{ mA}$

o High Gain

MAG = 10.5 dB Typ. @ f = 2 GHz, $V_{CE} = 3\text{ V}$, $I_C = 20\text{ mA}$

MAG = 8.5 dB Typ. @ f = 2 GHz, $V_{CE} = 1\text{ V}$, $I_C = 3\text{ mA}$

o High Transition Frequency

$f_T = 16.5\text{ GHz}$ Typ. @ $V_{CE} = 3\text{ V}$, $I_C = 20\text{ mA}$

h_{FE} Classification

Marking	AG1	AG2
h_{FE}	125 to 300	80 to 160

Absolute Maximum Ratings

Symbol	Parameter	Ratings	Unit
V_{CBO}	Collector to Base Breakdown Voltage	15	V
V_{CEO}	Collector to Emitter Breakdown Voltage	6	V
V_{EBO}	Emitter to Base Breakdown Voltage	2.5	V
I_C	Collector Current (DC)	35	mA
P_T	Total Power Dissipation	150	mW
T_{STG}	Storage Temperature	-65 ~ 150	°C
T_J	Operating Junction Temperature	150	°C

Caution : ESD sensitive device

SOT 523 Unit in mm

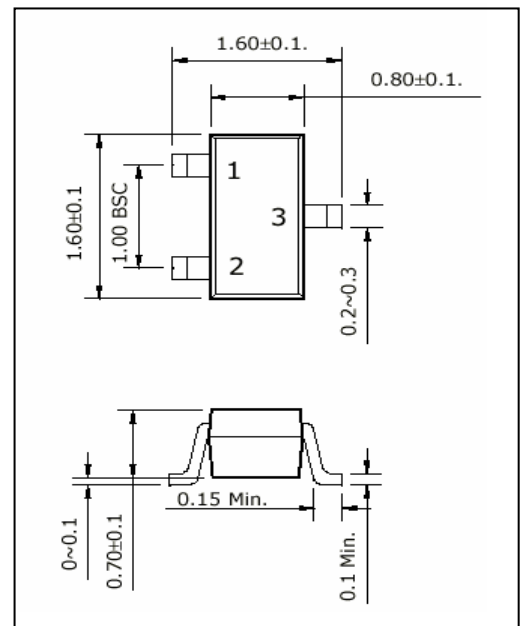

Pin Configuration

Pin No	Symbol	Description
1	B	Base
2	E	Emitter
3	C	Collector

Available Package Unit : mm

Product	Package	Dimension
THN4201U	SOT323	2.0 x 1.25, 1.0t
THN4201Z	SOT343	2.0 x 1.25, 1.0t
THN4201E	SOT523	1.6 x 0.8, 0.8t
THN4201KF	SOT623F	1.4 x 0.8, 0.6t

□ Electrical Characteristics ($T_A = 25\text{ }^\circ\text{C}$)

Symbol	Parameter	Test Condition	Value			Unit
			Min.	Typ.	Max.	
I_{CBO}	Collector Cut-off Current	$V_{CB} = 10\text{ V}, I_E = 0\text{ mA}$	-	-	0.5	μA
I_{CEO}		$V_{CE} = 6\text{ V}, I_B = 0\text{ mA}$	-	-	5	μA
I_{EBO}	Emitter Cut-off Current	$V_{EB} = 1\text{ V}, I_C = 0\text{ mA}$	-	-	0.5	μA
h_{FE}	DC Current Gain	$V_{CE} = 3\text{ V}, I_C = 15\text{ mA}$	80	200	300	
f_T	Transition Frequency	$V_{CE} = 3\text{ V}, I_C = 20\text{ mA}$	-	16.5	-	GHz
C_{CB}	Collector to Base Capacitance	$V_{CB} = 10\text{ V}, f = 1\text{ MHz}$	-	0.48	-	pF
$ S_{21} ^2$	Insertion Power Gain	$V_{CE} = 3\text{ V}, I_C = 15\text{ mA}, f = 2\text{ GHz}$	7.5	8.4	-	dB
		$V_{CE} = 1\text{ V}, I_C = 10\text{ mA}, f = 2\text{ GHz}$	6	7.5	-	
MAG	Maximum Available Gain	$V_{CE} = 3\text{ V}, I_C = 15\text{ mA}, f = 2\text{ GHz}$	8.5	10.3	-	dB
		$V_{CE} = 1\text{ V}, I_C = 10\text{ mA}, f = 2\text{ GHz}$	8	9.5	-	
NFmin	Minimum Noise Figure	$V_{CE} = 3\text{ V}, I_C = 5\text{ mA}, f = 2\text{ GHz}$	-	1.5	-	dB
		$V_{CE} = 1\text{ V}, I_C = 3\text{ mA}, f = 2\text{ GHz}$	-	1.7	-	
rn	Noise Resistance	$V_{CE} = 3\text{ V}, I_C = 5\text{ mA}, f = 2\text{ GHz}$	-	0.04	-	Ω
		$V_{CE} = 1\text{ V}, I_C = 3\text{ mA}, f = 2\text{ GHz}$	-	0.05	-	
G_A	Associated Gain	$V_{CE} = 3\text{ V}, I_C = 5\text{ mA}, f = 2\text{ GHz}$	-	8	-	dB
		$V_{CE} = 1\text{ V}, I_C = 3\text{ mA}, f = 2\text{ GHz}$	-	7	-	

Total Power Dissipation, P_T vs. T_A

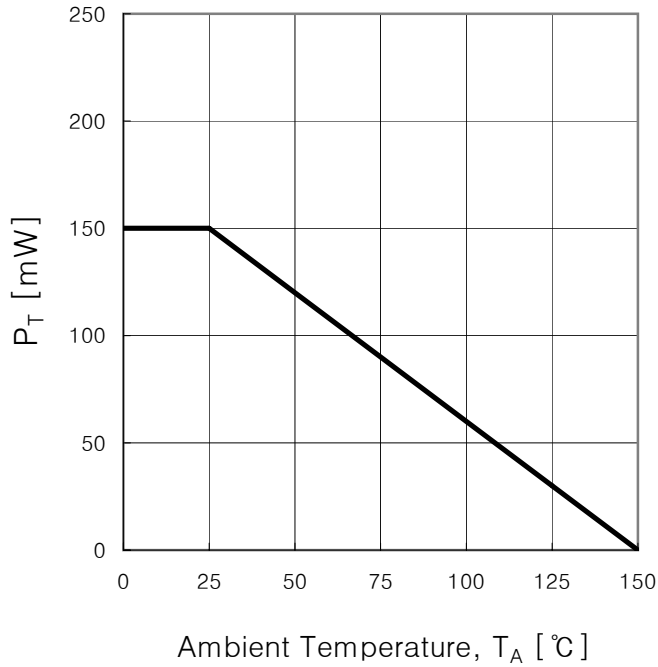

I_C vs. V_{CE}

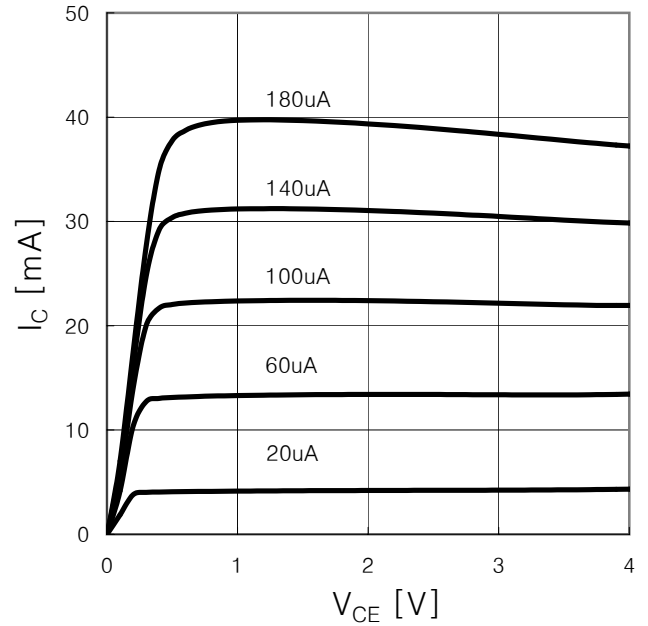

I_C vs. V_{BE}

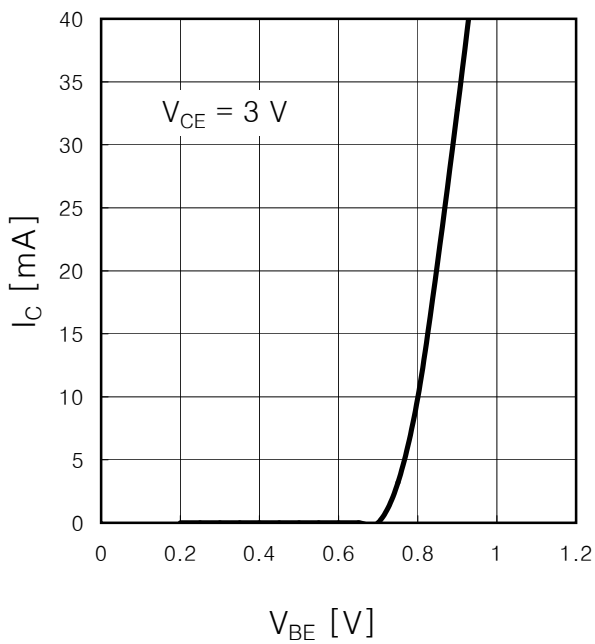

h_{FE} vs. I_C

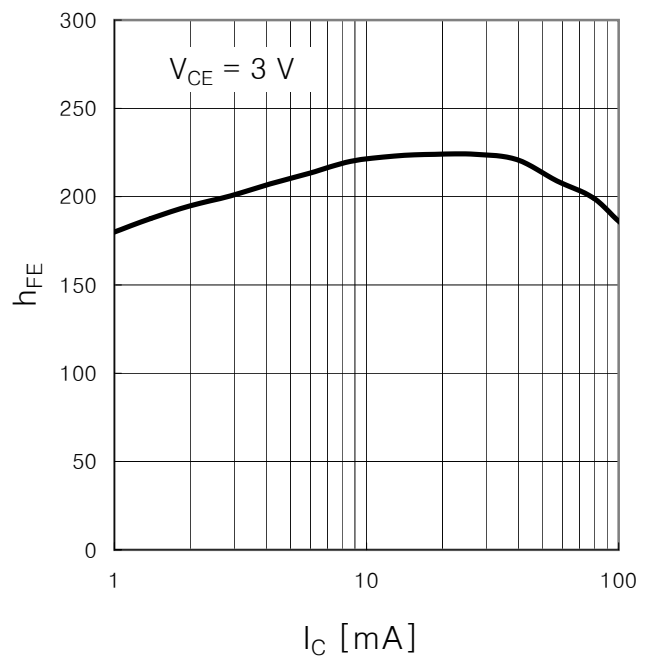

Maximum Available Gain, MAG vs. Frequency

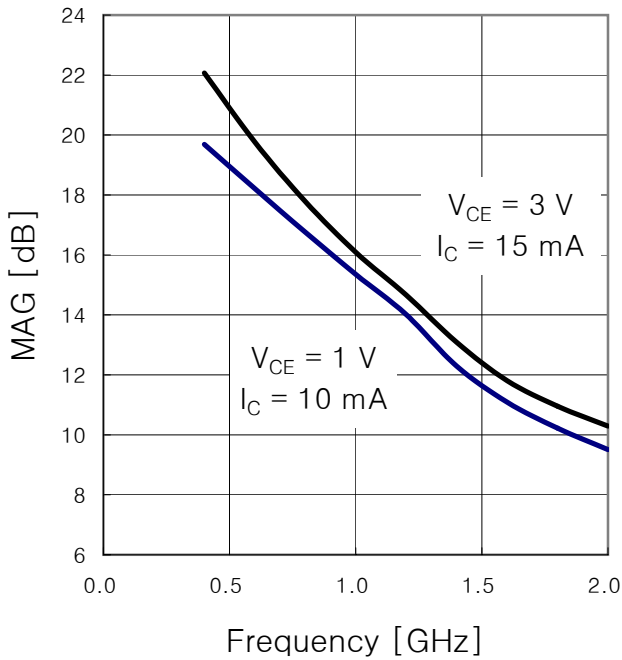

Insertion Power Gain, |S₂₁|² vs. Frequency

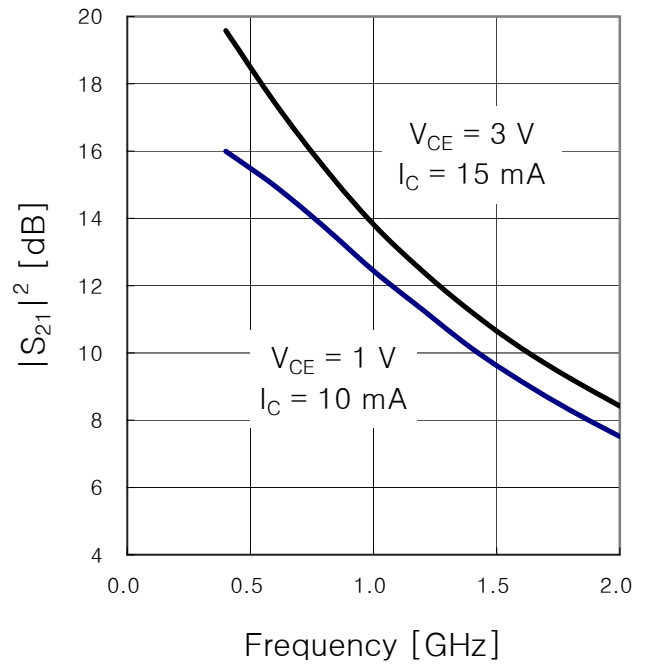

Maximum Available Gain, MAG vs. I_C

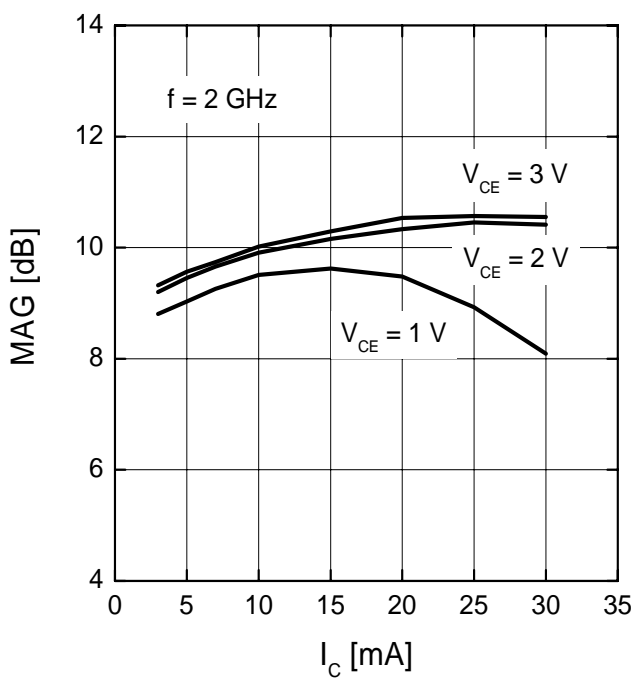

Insertion Power Gain, |S₂₁|² vs. I_C

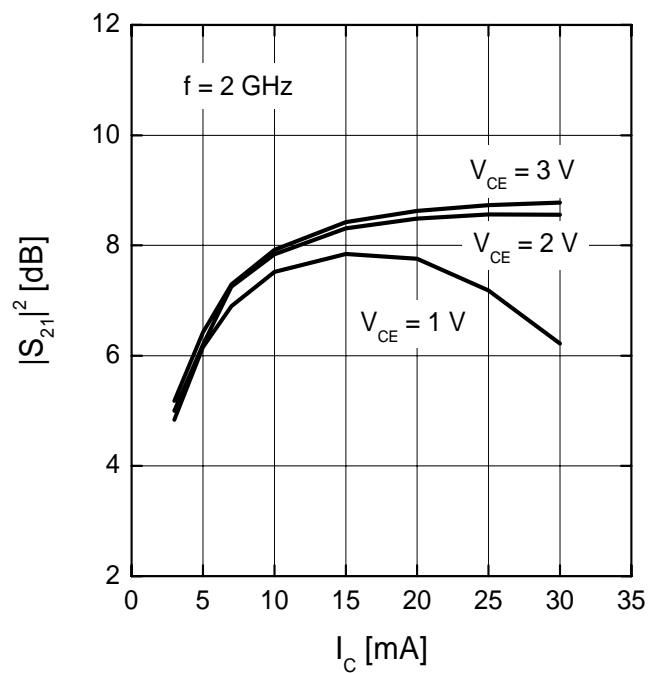

Transition Frequency, f_T vs. I_C

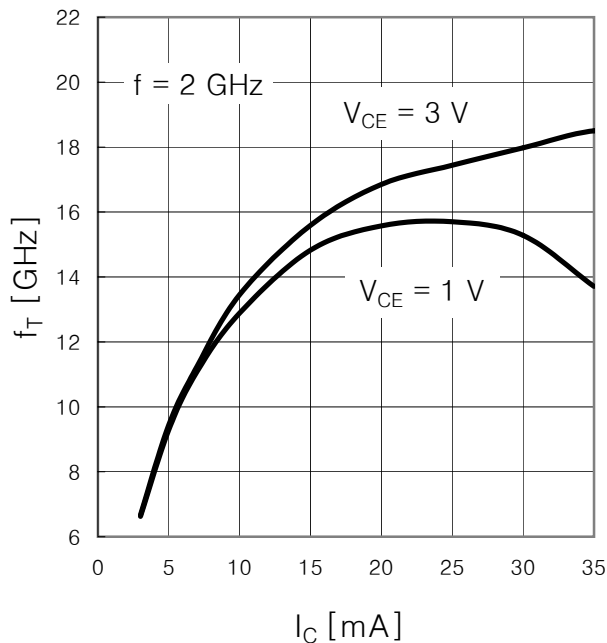

C_{CB} vs. V_{CB}

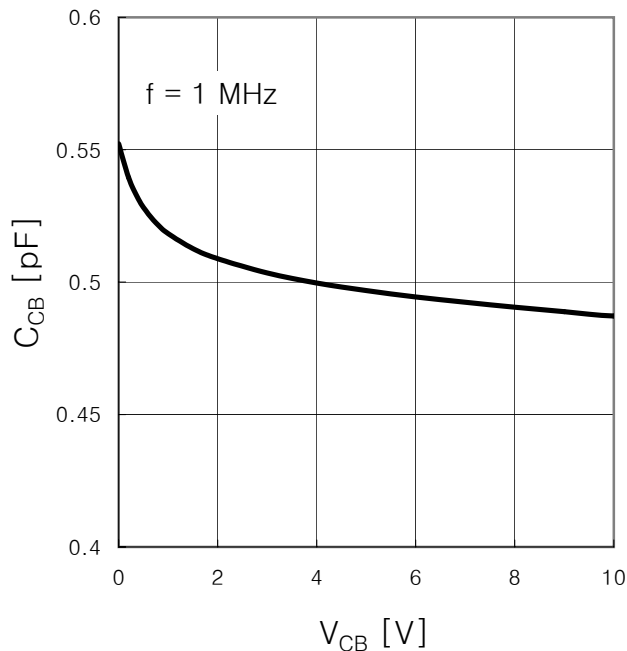

NF vs. I_C

$V_{CE} = 3\text{ V}$, $I_C = \text{parameter}$, $Z_S = Z_{\text{Sopt}}$

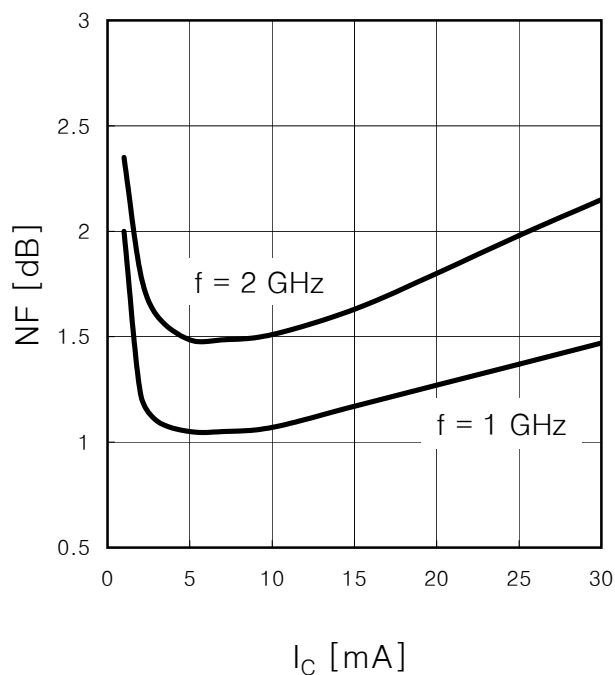

Noise Figure Contours & Constant Gain

$f = 1\text{ GHz or } 2\text{ GHz}$, $V_{CE} = 3\text{ V}$, $I_C = 5\text{ mA}$

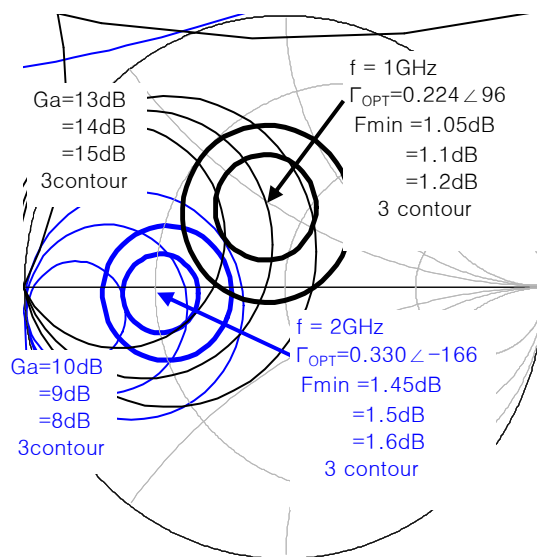

□ Dimensions of THN4201U in mm

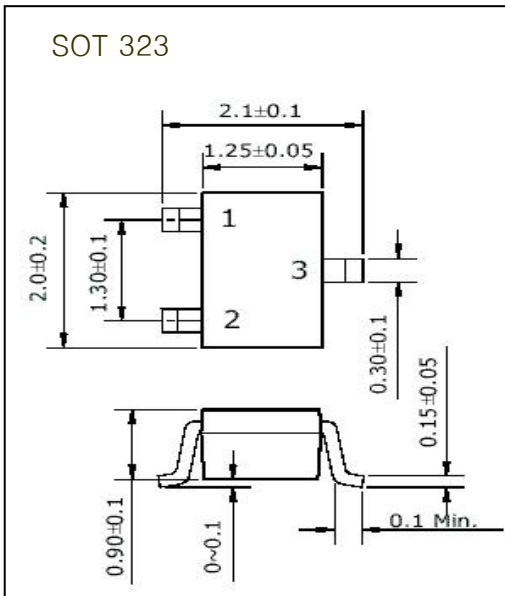

□ Dimensions of THN4201Z in mm

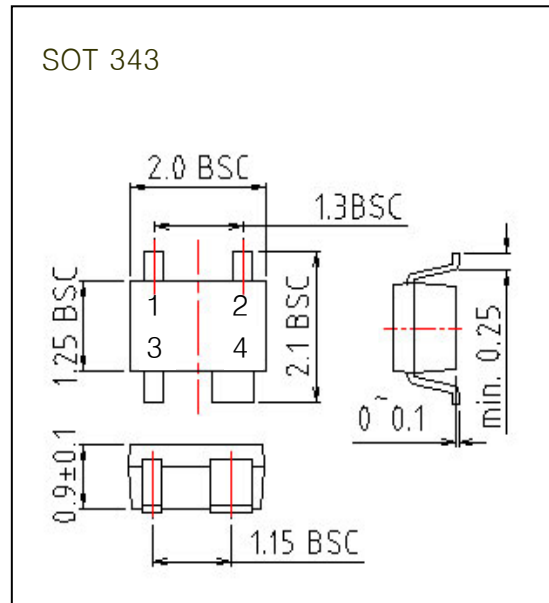

□ Dimensions of THN4201KF in mm

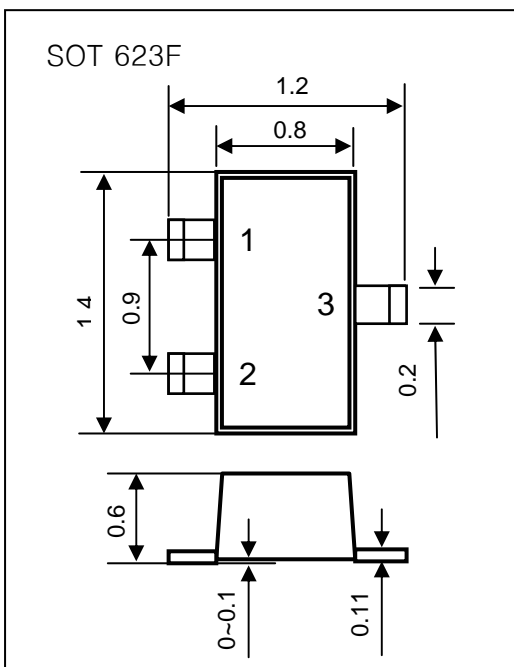

Pin Configuration (SOT 343)

Pin No	Symbol	Description
1	B	Base
2, 3	E	Emitter
4	C	Collector

Pin Configuration (SOT 323, SOT 623F)

Pin No	Symbol	Description
1	B	Base
2	E	Emitter
3	C	Collector

Common Emitter S-Parameter Data

 at $V_{CE} = 3\text{ V}$, $I_C = 3\text{ mA}$

freq	S(1,1)	S(2,1)	S(1,2)	S(2,2)
400.0MHz	0.655 / -62.653	5.792 / 120.819	0.101 / 50.011	0.704 / -55.506
600.0MHz	0.580 / -83.331	4.562 / 107.868	0.117 / 43.304	0.589 / -69.918
800.0MHz	0.533 / -99.683	3.746 / 97.800	0.124 / 41.205	0.508 / -80.314
1.000GHz	0.515 / -113.307	3.165 / 90.290	0.129 / 41.892	0.460 / -88.925
1.200GHz	0.485 / -125.329	2.789 / 82.271	0.134 / 44.398	0.436 / -96.143
1.400GHz	0.488 / -135.100	2.441 / 76.638	0.139 / 47.474	0.425 / -103.034
1.600GHz	0.468 / -144.580	2.204 / 69.486	0.147 / 51.283	0.418 / -109.702
1.800GHz	0.459 / -152.505	1.999 / 63.265	0.158 / 54.939	0.426 / -116.268
2.000GHz	0.453 / -159.271	1.815 / 56.769	0.171 / 57.641	0.441 / -122.278

 at $V_{CE} = 3\text{ V}$, $I_C = 5\text{ mA}$

freq	S(1,1)	S(2,1)	S(1,2)	S(2,2)
400.0MHz	0.609 / -68.450	6.552 / 118.380	0.086 / 50.120	0.593 / -65.801
600.0MHz	0.527 / -91.519	5.192 / 105.354	0.099 / 47.824	0.473 / -80.110
800.0MHz	0.477 / -109.763	4.305 / 95.373	0.109 / 49.290	0.402 / -89.913
1.000GHz	0.456 / -124.148	3.648 / 87.908	0.120 / 52.065	0.362 / -98.142
1.200GHz	0.428 / -136.234	3.207 / 80.362	0.132 / 54.879	0.344 / -104.709
1.400GHz	0.427 / -145.070	2.804 / 74.564	0.146 / 57.303	0.336 / -110.863
1.600GHz	0.412 / -154.253	2.528 / 68.212	0.160 / 59.276	0.333 / -116.822
1.800GHz	0.404 / -161.687	2.294 / 62.527	0.177 / 60.663	0.344 / -122.479
2.000GHz	0.396 / -167.977	2.094 / 56.427	0.194 / 60.926	0.359 / -127.254

 at $V_{CE} = 3\text{ V}$, $I_C = 7\text{ mA}$

freq	S(1,1)	S(2,1)	S(1,2)	S(2,2)
400.0MHz	0.563 / -75.070	7.307 / 115.901	0.075 / 52.425	0.500 / -74.936
600.0MHz	0.479 / -100.757	5.812 / 102.783	0.088 / 53.417	0.392 / -88.821
800.0MHz	0.428 / -120.966	4.826 / 92.906	0.103 / 56.522	0.331 / -98.505
1.000GHz	0.407 / -135.525	4.084 / 85.495	0.118 / 59.343	0.301 / -106.431
1.200GHz	0.385 / -147.324	3.570 / 78.618	0.135 / 61.536	0.288 / -112.706
1.400GHz	0.383 / -155.129	3.117 / 72.977	0.153 / 62.893	0.284 / -118.288
1.600GHz	0.373 / -163.770	2.797 / 67.358	0.171 / 63.564	0.283 / -123.899
1.800GHz	0.368 / -170.494	2.532 / 62.176	0.190 / 63.685	0.294 / -128.635
2.000GHz	0.359 / -176.316	2.316 / 56.494	0.209 / 62.659	0.309 / -132.369

 at $V_{CE} = 3\text{ V}$, $I_C = 10\text{ mA}$

freq	S(1,1)	S(2,1)	S(1,2)	S(2,2)
400.0MHz	0.510 / -83.850	8.205 / 112.843	0.066 / 56.275	0.420 / -83.808
600.0MHz	0.429 / -113.017	6.504 / 99.736	0.082 / 59.625	0.329 / -97.359
800.0MHz	0.383 / -134.847	5.373 / 90.023	0.100 / 62.794	0.280 / -106.977
1.000GHz	0.367 / -148.562	4.506 / 83.025	0.119 / 64.915	0.257 / -114.882
1.200GHz	0.355 / -158.565	3.893 / 77.079	0.138 / 66.250	0.249 / -120.706
1.400GHz	0.354 / -165.482	3.392 / 71.842	0.159 / 66.628	0.248 / -126.025
1.600GHz	0.351 / -172.786	3.021 / 66.868	0.179 / 66.345	0.249 / -131.145
1.800GHz	0.347 / -178.797	2.729 / 62.093	0.200 / 65.628	0.261 / -135.101
2.000GHz	0.339 / 176.000	2.489 / 56.749	0.221 / 63.819	0.275 / -137.754

at $V_{CE} = 3\text{ V}$, $I_C = 15\text{ mA}$

freq	S(1,1)	S(2,1)	S(1,2)	S(2,2)
400.0MHz	0.436 / -100.493	9.529 / 108.147	0.059 / 62.483	0.343 / -94.373
600.0MHz	0.374 / -133.901	7.440 / 95.134	0.078 / 66.432	0.273 / -107.498
800.0MHz	0.346 / -152.999	5.967 / 86.624	0.099 / 68.836	0.237 / -117.087
1.000GHz	0.341 / -162.920	4.908 / 80.766	0.121 / 69.900	0.223 / -124.752
1.200GHz	0.338 / -169.961	4.182 / 75.830	0.143 / 70.204	0.219 / -130.177
1.400GHz	0.340 / -175.451	3.632 / 71.139	0.165 / 69.684	0.220 / -134.851
1.600GHz	0.340 / 178.533	3.215 / 66.667	0.187 / 68.638	0.223 / -139.510
1.800GHz	0.337 / 173.325	2.897 / 62.231	0.209 / 67.234	0.235 / -142.442
2.000GHz	0.328 / 168.554	2.637 / 57.182	0.231 / 64.780	0.247 / -144.043

 at $V_{CE} = 3\text{ V}$, $I_C = 20\text{ mA}$

freq	S(1,1)	S(2,1)	S(1,2)	S(2,2)
400.0MHz	0.390 / -117.030	10.521 / 104.190	0.056 / 66.624	0.304 / -101.073
600.0MHz	0.349 / -148.894	7.973 / 92.015	0.077 / 70.204	0.247 / -113.753
800.0MHz	0.336 / -162.419	6.224 / 84.987	0.100 / 71.868	0.218 / -123.262
1.000GHz	0.336 / -169.793	5.076 / 79.799	0.122 / 72.269	0.208 / -130.590
1.200GHz	0.335 / -175.376	4.303 / 75.279	0.146 / 72.066	0.206 / -135.637
1.400GHz	0.338 / 179.855	3.731 / 70.838	0.169 / 71.109	0.209 / -139.911
1.600GHz	0.339 / 174.409	3.298 / 66.574	0.191 / 69.740	0.213 / -144.162
1.800GHz	0.336 / 169.506	2.968 / 62.291	0.214 / 67.972	0.224 / -146.637
2.000GHz	0.327 / 164.921	2.700 / 57.382	0.237 / 65.275	0.236 / -147.619

 at $V_{CE} = 3\text{ V}$, $I_C = 25\text{ mA}$

freq	S(1,1)	S(2,1)	S(1,2)	S(2,2)
400.0MHz	0.366 / -133.124	11.237 / 100.655	0.055 / 69.669	0.280 / -105.942
600.0MHz	0.342 / -158.113	8.232 / 90.163	0.077 / 72.624	0.231 / -118.204
800.0MHz	0.334 / -167.867	6.347 / 84.058	0.100 / 73.751	0.207 / -127.490
1.000GHz	0.335 / -173.858	5.156 / 79.215	0.124 / 73.748	0.199 / -134.547
1.200GHz	0.336 / -178.645	4.364 / 74.904	0.147 / 73.162	0.199 / -139.230
1.400GHz	0.339 / 176.968	3.780 / 70.621	0.171 / 72.001	0.202 / -143.206
1.600GHz	0.340 / 171.921	3.340 / 66.465	0.194 / 70.394	0.207 / -147.156
1.800GHz	0.337 / 167.162	3.004 / 62.273	0.217 / 68.455	0.219 / -149.277
2.000GHz	0.328 / 162.680	2.732 / 57.420	0.240 / 65.576	0.229 / -149.950

 at $V_{CE} = 3\text{ V}$, $I_C = 30\text{ mA}$

freq	S(1,1)	S(2,1)	S(1,2)	S(2,2)
400.0MHz	0.358 / -147.052	11.635 / 97.677	0.054 / 72.081	0.262 / -109.798
600.0MHz	0.341 / -164.174	8.347 / 88.951	0.077 / 74.509	0.220 / -121.575
800.0MHz	0.336 / -171.666	6.404 / 83.394	0.101 / 75.173	0.199 / -130.652
1.000GHz	0.338 / -176.730	5.195 / 78.764	0.125 / 74.840	0.193 / -137.385
1.200GHz	0.339 / 178.995	4.392 / 74.595	0.149 / 74.031	0.194 / -141.786
1.400GHz	0.342 / 174.948	3.804 / 70.401	0.172 / 72.657	0.198 / -145.525
1.600GHz	0.343 / 170.120	3.360 / 66.319	0.196 / 70.897	0.204 / -149.221
1.800GHz	0.340 / 165.511	3.021 / 62.169	0.219 / 68.823	0.215 / -151.129
2.000GHz	0.331 / 161.081	2.748 / 57.384	0.242 / 65.859	0.225 / -151.470

at $V_{CE} = 2\text{ V}$, $I_C = 3\text{ mA}$

freq	S(1,1)	S(2,1)	S(1,2)	S(2,2)
400.0MHz	0.659 / -62.657	5.619 / 120.850	0.104 / 49.909	0.713 / -54.996
600.0MHz	0.585 / -83.211	4.443 / 107.853	0.120 / 42.709	0.597 / -69.666
800.0MHz	0.539 / -99.503	3.652 / 97.728	0.127 / 40.367	0.515 / -80.259
1.000GHz	0.521 / -113.106	3.087 / 90.179	0.132 / 40.892	0.467 / -89.021
1.200GHz	0.491 / -125.236	2.726 / 82.108	0.136 / 43.108	0.442 / -96.439
1.400GHz	0.495 / -134.960	2.384 / 76.498	0.140 / 46.417	0.431 / -103.376
1.600GHz	0.475 / -144.503	2.156 / 69.281	0.147 / 50.212	0.424 / -110.121
1.800GHz	0.466 / -152.411	1.955 / 63.037	0.158 / 54.097	0.432 / -116.728
2.000GHz	0.460 / -159.294	1.779 / 56.506	0.170 / 56.967	0.447 / -122.838

 at $V_{CE} = 2\text{ V}$, $I_C = 5\text{ mA}$

freq	S(1,1)	S(2,1)	S(1,2)	S(2,2)
400.0MHz	0.605 / -69.946	6.483 / 117.927	0.086 / 49.956	0.579 / -67.469
600.0MHz	0.523 / -93.191	5.176 / 104.839	0.098 / 48.066	0.462 / -81.878
800.0MHz	0.473 / -111.648	4.296 / 94.880	0.109 / 49.865	0.391 / -91.863
1.000GHz	0.453 / -125.988	3.647 / 87.399	0.120 / 52.645	0.353 / -100.122
1.200GHz	0.426 / -138.133	3.209 / 79.895	0.133 / 55.529	0.336 / -106.727
1.400GHz	0.425 / -146.780	2.806 / 74.087	0.147 / 57.791	0.329 / -112.781
1.600GHz	0.410 / -156.000	2.531 / 67.812	0.163 / 59.600	0.326 / -118.791
1.800GHz	0.403 / -163.272	2.297 / 62.185	0.180 / 60.834	0.337 / -124.234
2.000GHz	0.394 / -169.593	2.100 / 56.129	0.197 / 60.887	0.352 / -128.902

 at $V_{CE} = 2\text{ V}$, $I_C = 7\text{ mA}$

freq	S(1,1)	S(2,1)	S(1,2)	S(2,2)
400.0MHz	0.559 / -76.888	7.190 / 115.420	0.075 / 52.338	0.490 / -76.433
600.0MHz	0.477 / -102.517	5.763 / 102.326	0.088 / 53.649	0.385 / -90.496
800.0MHz	0.427 / -122.781	4.796 / 92.445	0.103 / 56.818	0.326 / -100.311
1.000GHz	0.408 / -137.259	4.062 / 85.052	0.119 / 59.599	0.296 / -108.345
1.200GHz	0.386 / -148.957	3.551 / 78.227	0.136 / 61.758	0.284 / -114.612
1.400GHz	0.384 / -156.675	3.101 / 72.588	0.154 / 63.000	0.281 / -120.168
1.600GHz	0.376 / -165.197	2.783 / 67.035	0.172 / 63.620	0.280 / -125.758
1.800GHz	0.371 / -171.815	2.521 / 61.875	0.192 / 63.643	0.292 / -130.374
2.000GHz	0.362 / -177.586	2.305 / 56.233	0.212 / 62.555	0.307 / -133.978

 at $V_{CE} = 2\text{ V}$, $I_C = 10\text{ mA}$

freq	S(1,1)	S(2,1)	S(1,2)	S(2,2)
400.0MHz	0.509 / -86.316	7.974 / 112.341	0.066 / 56.170	0.414 / -85.174
600.0MHz	0.431 / -114.756	6.410 / 99.347	0.083 / 59.625	0.325 / -98.917
800.0MHz	0.387 / -136.372	5.309 / 89.647	0.100 / 62.869	0.278 / -108.719
1.000GHz	0.371 / -149.957	4.457 / 82.673	0.119 / 64.991	0.256 / -116.698
1.200GHz	0.360 / -159.804	3.853 / 76.751	0.139 / 66.241	0.249 / -122.483
1.400GHz	0.359 / -166.557	3.358 / 71.523	0.160 / 66.600	0.248 / -127.769
1.600GHz	0.356 / -173.753	2.992 / 66.575	0.180 / 66.316	0.250 / -132.789
1.800GHz	0.353 / -179.752	2.703 / 61.792	0.201 / 65.515	0.262 / -136.660
2.000GHz	0.344 / 175.065	2.466 / 56.488	0.222 / 63.701	0.275 / -139.238

at $V_{CE} = 2\text{ V}$, $I_C = 15\text{ mA}$

freq	S(1,1)	S(2,1)	S(1,2)	S(2,2)
400.0MHz	0.441 / -105.096	9.081 / 107.336	0.059 / 62.296	0.338 / -95.897
600.0MHz	0.381 / -135.871	7.277 / 94.709	0.079 / 66.357	0.271 / -109.217
800.0MHz	0.354 / -154.364	5.867 / 86.249	0.100 / 68.769	0.237 / -118.901
1.000GHz	0.349 / -163.997	4.832 / 80.434	0.121 / 69.891	0.223 / -126.548
1.200GHz	0.347 / -170.826	4.120 / 75.508	0.144 / 70.139	0.220 / -131.826
1.400GHz	0.348 / -176.272	3.579 / 70.794	0.166 / 69.641	0.222 / -136.527
1.600GHz	0.348 / 177.891	3.172 / 66.329	0.188 / 68.586	0.226 / -140.989
1.800GHz	0.345 / 172.650	2.857 / 61.881	0.211 / 67.133	0.237 / -143.925
2.000GHz	0.336 / 167.913	2.602 / 56.856	0.233 / 64.698	0.249 / -145.428

 at $V_{CE} = 2\text{ V}$, $I_C = 20\text{ mA}$

freq	S(1,1)	S(2,1)	S(1,2)	S(2,2)
400.0MHz	0.409 / -123.768	9.822 / 103.030	0.057 / 66.628	0.299 / -102.792
600.0MHz	0.364 / -151.250	7.716 / 91.445	0.078 / 70.185	0.245 / -115.655
800.0MHz	0.347 / -163.730	6.088 / 84.565	0.100 / 71.850	0.218 / -125.162
1.000GHz	0.346 / -170.754	4.976 / 79.409	0.123 / 72.236	0.209 / -132.413
1.200GHz	0.346 / -176.196	4.226 / 74.889	0.146 / 72.013	0.208 / -137.322
1.400GHz	0.348 / 179.089	3.666 / 70.439	0.170 / 71.062	0.211 / -141.547
1.600GHz	0.349 / 173.811	3.243 / 66.177	0.192 / 69.684	0.216 / -145.628
1.800GHz	0.346 / 168.929	2.919 / 61.860	0.215 / 67.901	0.228 / -148.067
2.000GHz	0.337 / 164.377	2.658 / 56.965	0.238 / 65.211	0.238 / -148.956

 at $V_{CE} = 2\text{ V}$, $I_C = 25\text{ mA}$

freq	S(1,1)	S(2,1)	S(1,2)	S(2,2)
400.0MHz	0.400 / -142.497	10.305 / 98.833	0.055 / 69.955	0.272 / -108.371
600.0MHz	0.367 / -161.680	7.830 / 89.217	0.078 / 72.905	0.228 / -120.687
800.0MHz	0.351 / -169.786	6.155 / 83.420	0.101 / 73.957	0.206 / -129.917
1.000GHz	0.350 / -175.253	5.029 / 78.656	0.124 / 73.923	0.200 / -136.795
1.200GHz	0.350 / -179.770	4.267 / 74.387	0.148 / 73.310	0.200 / -141.260
1.400GHz	0.353 / 175.982	3.701 / 70.086	0.172 / 72.070	0.205 / -145.093
1.600GHz	0.353 / 171.084	3.272 / 65.936	0.195 / 70.454	0.210 / -148.853
1.800GHz	0.350 / 166.426	2.945 / 61.724	0.219 / 68.480	0.222 / -150.873
2.000GHz	0.341 / 161.981	2.681 / 56.882	0.242 / 65.574	0.232 / -151.427

 at $V_{CE} = 2\text{ V}$, $I_C = 30\text{ mA}$

freq	S(1,1)	S(2,1)	S(1,2)	S(2,2)
400.0MHz	0.406 / -154.067	10.409 / 96.061	0.054 / 72.025	0.255 / -112.030
600.0MHz	0.378 / -167.267	7.744 / 87.948	0.077 / 74.544	0.218 / -123.883
800.0MHz	0.361 / -173.393	6.102 / 82.637	0.101 / 75.184	0.199 / -132.844
1.000GHz	0.358 / -177.919	5.006 / 78.092	0.125 / 74.890	0.195 / -139.378
1.200GHz	0.357 / 178.055	4.257 / 73.948	0.150 / 74.063	0.196 / -143.550
1.400GHz	0.359 / 174.145	3.694 / 69.748	0.173 / 72.669	0.201 / -147.050
1.600GHz	0.360 / 169.424	3.268 / 65.648	0.197 / 70.919	0.207 / -150.678
1.800GHz	0.357 / 164.924	2.941 / 61.478	0.221 / 68.834	0.219 / -152.421
2.000GHz	0.347 / 160.554	2.678 / 56.665	0.244 / 65.851	0.230 / -152.811

at $V_{CE} = 1\text{ V}$, $I_C = 3\text{ mA}$

freq	S(1,1)	S(2,1)	S(1,2)	S(2,2)
400.0MHz	0.638 / -69.629	4.957 / 119.268	0.107 / 48.945	0.699 / -57.251
600.0MHz	0.578 / -86.836	4.219 / 106.749	0.123 / 42.022	0.582 / -72.535
800.0MHz	0.534 / -102.324	3.539 / 96.780	0.130 / 39.805	0.502 / -83.384
1.000GHz	0.518 / -115.657	3.006 / 89.283	0.135 / 40.457	0.454 / -92.409
1.200GHz	0.491 / -127.718	2.661 / 81.278	0.139 / 42.648	0.431 / -99.882
1.400GHz	0.494 / -137.370	2.328 / 75.553	0.145 / 45.731	0.419 / -106.942
1.600GHz	0.475 / -146.838	2.109 / 68.484	0.152 / 49.403	0.413 / -113.638
1.800GHz	0.467 / -154.564	1.916 / 62.301	0.162 / 52.998	0.423 / -120.047
2.000GHz	0.461 / -161.356	1.745 / 55.823	0.176 / 55.598	0.437 / -125.976

 at $V_{CE} = 1\text{ V}$, $I_C = 5\text{ mA}$

freq	S(1,1)	S(2,1)	S(1,2)	S(2,2)
400.0MHz	0.585 / -80.141	5.473 / 116.004	0.089 / 48.923	0.573 / -69.531
600.0MHz	0.522 / -98.446	4.763 / 103.625	0.102 / 46.988	0.459 / -84.690
800.0MHz	0.477 / -114.673	4.080 / 94.018	0.113 / 48.681	0.389 / -95.228
1.000GHz	0.460 / -128.256	3.489 / 86.655	0.124 / 51.435	0.352 / -103.786
1.200GHz	0.434 / -140.243	3.084 / 79.229	0.137 / 54.151	0.336 / -110.605
1.400GHz	0.434 / -148.668	2.697 / 73.381	0.151 / 56.501	0.329 / -116.753
1.600GHz	0.420 / -157.751	2.440 / 67.172	0.166 / 58.277	0.327 / -122.673
1.800GHz	0.413 / -164.988	2.216 / 61.560	0.183 / 59.530	0.338 / -128.102
2.000GHz	0.404 / -171.138	2.032 / 55.534	0.200 / 59.573	0.354 / -132.499

 at $V_{CE} = 1\text{ V}$, $I_C = 7\text{ mA}$

freq	S(1,1)	S(2,1)	S(1,2)	S(2,2)
400.0MHz	0.545 / -90.401	5.849 / 113.209	0.078 / 51.070	0.489 / -78.532
600.0MHz	0.485 / -109.773	5.152 / 100.952	0.092 / 52.216	0.387 / -93.553
800.0MHz	0.439 / -126.336	4.465 / 91.570	0.106 / 55.298	0.329 / -103.945
1.000GHz	0.422 / -139.446	3.838 / 84.403	0.122 / 58.105	0.301 / -112.386
1.200GHz	0.402 / -150.633	3.376 / 77.647	0.139 / 60.366	0.290 / -118.757
1.400GHz	0.399 / -158.182	2.956 / 71.952	0.157 / 61.635	0.286 / -124.405
1.600GHz	0.391 / -166.486	2.661 / 66.419	0.175 / 62.333	0.286 / -129.927
1.800GHz	0.386 / -173.067	2.415 / 61.243	0.195 / 62.404	0.299 / -134.418
2.000GHz	0.377 / -178.835	2.213 / 55.605	0.214 / 61.388	0.312 / -137.881

 at $V_{CE} = 1\text{ V}$, $I_C = 10\text{ mA}$

freq	S(1,1)	S(2,1)	S(1,2)	S(2,2)
400.0MHz	0.504 / -107.555	6.305 / 109.062	0.068 / 55.393	0.402 / -89.248
600.0MHz	0.452 / -128.068	5.599 / 96.980	0.084 / 59.030	0.321 / -104.121
800.0MHz	0.408 / -144.082	4.869 / 88.014	0.103 / 62.328	0.278 / -114.459
1.000GHz	0.392 / -154.679	4.189 / 81.520	0.122 / 64.422	0.259 / -122.631
1.200GHz	0.380 / -163.306	3.664 / 75.856	0.143 / 65.650	0.252 / -128.494
1.400GHz	0.378 / -169.577	3.209 / 70.662	0.163 / 65.928	0.252 / -133.591
1.600GHz	0.375 / -176.341	2.870 / 65.798	0.184 / 65.607	0.255 / -138.533
1.800GHz	0.371 / 177.928	2.598 / 61.055	0.206 / 64.769	0.267 / -142.059
2.000GHz	0.362 / 172.848	2.376 / 55.803	0.227 / 62.902	0.280 / -144.317

at $V_{CE} = 1\text{ V}$, $I_C = 15\text{ mA}$

freq	S(1,1)	S(2,1)	S(1,2)	S(2,2)
400.0MHz	0.491 / -132.907	6.723 / 103.233	0.060 / 61.597	0.329 / -100.786
600.0MHz	0.448 / -152.213	5.922 / 91.651	0.081 / 65.860	0.272 / -115.243
800.0MHz	0.412 / -162.990	5.044 / 84.275	0.102 / 68.229	0.242 / -125.371
1.000GHz	0.397 / -169.408	4.316 / 78.914	0.124 / 69.307	0.231 / -133.095
1.200GHz	0.386 / -174.532	3.779 / 74.220	0.147 / 69.560	0.229 / -138.094
1.400GHz	0.382 / -179.327	3.327 / 69.608	0.169 / 69.017	0.231 / -142.496
1.600GHz	0.378 / 175.471	2.980 / 65.230	0.192 / 67.959	0.236 / -146.702
1.800GHz	0.374 / 170.524	2.698 / 60.807	0.215 / 66.483	0.248 / -149.320
2.000GHz	0.364 / 165.940	2.467 / 55.826	0.237 / 64.039	0.259 / -150.636

 at $V_{CE} = 1\text{ V}$, $I_C = 20\text{ mA}$

freq	S(1,1)	S(2,1)	S(1,2)	S(2,2)
400.0MHz	0.518 / -153.617	6.852 / 97.979	0.057 / 66.124	0.287 / -109.753
600.0MHz	0.473 / -166.563	5.831 / 88.001	0.080 / 69.916	0.246 / -123.479
800.0MHz	0.441 / -172.881	4.875 / 82.049	0.103 / 71.490	0.225 / -133.221
1.000GHz	0.426 / -177.397	4.157 / 77.207	0.126 / 71.835	0.219 / -140.383
1.200GHz	0.415 / 178.775	3.646 / 72.808	0.150 / 71.611	0.219 / -144.684
1.400GHz	0.408 / 174.759	3.228 / 68.507	0.173 / 70.595	0.223 / -148.386
1.600GHz	0.401 / 170.461	2.917 / 64.315	0.197 / 69.175	0.228 / -152.067
1.800GHz	0.394 / 166.090	2.659 / 60.071	0.220 / 67.412	0.241 / -153.963
2.000GHz	0.381 / 161.824	2.444 / 55.253	0.243 / 64.685	0.252 / -154.745

 at $V_{CE} = 1\text{ V}$, $I_C = 25\text{ mA}$

freq	S(1,1)	S(2,1)	S(1,2)	S(2,2)
400.0MHz	0.552 / -165.668	6.656 / 94.165	0.056 / 69.063	0.261 / -118.076
600.0MHz	0.506 / -173.579	5.495 / 85.867	0.080 / 72.358	0.233 / -130.717
800.0MHz	0.476 / -178.279	4.547 / 80.469	0.104 / 73.412	0.219 / -139.792
1.000GHz	0.463 / 177.900	3.859 / 75.779	0.128 / 73.335	0.216 / -146.263
1.200GHz	0.455 / 174.461	3.373 / 71.337	0.153 / 72.714	0.218 / -149.929
1.400GHz	0.448 / 170.656	2.989 / 67.148	0.177 / 71.483	0.223 / -153.028
1.600GHz	0.441 / 166.701	2.705 / 62.879	0.200 / 69.811	0.229 / -156.261
1.800GHz	0.433 / 162.591	2.476 / 58.645	0.225 / 67.910	0.243 / -157.579
2.000GHz	0.419 / 158.481	2.287 / 53.883	0.248 / 65.051	0.254 / -157.990

 at $V_{CE} = 1\text{ V}$, $I_C = 30\text{ mA}$

freq	S(1,1)	S(2,1)	S(1,2)	S(2,2)
400.0MHz	0.580 / -171.357	6.300 / 92.052	0.056 / 70.457	0.247 / -129.020
600.0MHz	0.536 / -177.268	5.107 / 84.488	0.081 / 73.357	0.230 / -139.799
800.0MHz	0.511 / 178.665	4.189 / 79.221	0.106 / 74.235	0.223 / -147.457
1.000GHz	0.501 / 175.070	3.531 / 74.475	0.131 / 73.983	0.225 / -152.750
1.200GHz	0.495 / 171.708	3.065 / 69.879	0.156 / 73.226	0.230 / -155.651
1.400GHz	0.490 / 167.954	2.705 / 65.625	0.181 / 71.847	0.237 / -158.237
1.600GHz	0.487 / 164.021	2.434 / 61.142	0.205 / 70.059	0.245 / -161.062
1.800GHz	0.481 / 159.901	2.220 / 56.774	0.230 / 68.002	0.259 / -162.226
2.000GHz	0.470 / 155.706	2.046 / 51.936	0.255 / 65.065	0.271 / -162.691