

# MODEL BCN SERIES

## Thick Film

## Chip Resistor Arrays

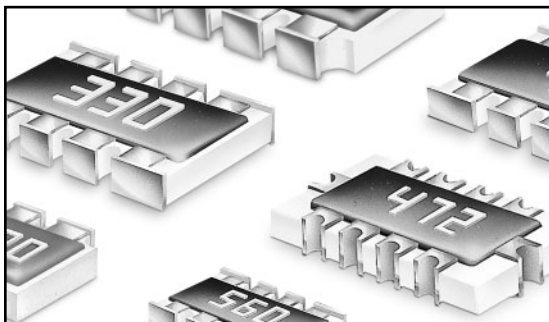

### MODEL STYLES

Model (Width)	# of Resistors	Circuit	Industry Size	Edge Finish / Termination		
				Scalloped Convex	Square Convex	Square Concave
Model BCN 102 (1.0mm)	2	Isolated	0404		•	
Model BCN 104 (1.0mm)	4	Isolated	0804		•	
Model BCN 16 4ABI (1.6mm)	4	Isolated	1206			•
Model BCN 16 4A/AB (1.6mm)	4	Isolated	1206	•	•	
Model BCN 16 8RB/8SB (1.6mm)	8	Bussed	1206		•	
Model BCN 21 (2.1mm)	8	Bussed	1608			•
Model BCN 4D (3.1mm)	4	Isolated	2112	•		
Model BCN 4DBI (3.1mm)	4	Isolated	2112			•
Model BCN 31 8RB/8SB (3.1mm)	8	Bussed	2512		•	
Model BCN 31 8RBI/8SBI (3.1mm)	8	Bussed	2512			•
Jumper Chip Array	4/8	Isolated/Bussed	1206/2512	•	•	•
	2/4	Isolated	0404/0804		•	

### FEATURES

- Reliable monolithic construction
- Nickel barrier terminations
- Top side marking for easy identification
- Concave or convex termination styles
- Square or scalloped edges available

### BENEFITS

- Saves board space over equivalent rated chip resistors
- Eliminates up to seven pick & place operations
- Single component reliability
- Leadless chip, reduced inductance
- Mounts close to active devices

### APPLICATIONS

- Pull up/pull down resistors for digital IC's
- Series termination on high speed data busses
- Current limit for LED displays

Specifications subject to change without notice.

## ELECTRICAL

Standard Resistance Range, Ohms	<b>BCN 4D, BCN 10, BCN16 4:</b> <b>BCN 16 8R/8S:</b> <b>BCN 31 8R/8S:</b> <b>BCN 21:</b>	10 to 1 Megohm 100 to 1 Megohm 22 to 1 Megohm 68 to 220K
Standard Resistance Tolerance		±5% (J. Tol.) Optional: ±1% (F Tol.), BCN 4D, BCN 16 4, BCN 318RB/8SB Only ±2% (G Tol.), BCN 16 4, BCN 31 8RB/8RS Only
Operating Voltage, Maximum	<b>BCN16 4, BCN 31 8R/8S:</b> <b>BCN 102, BCN 104, BCN 16 8R/8S, BCN 21:</b> <b>BCN 4D:</b>	50Vdc or $\sqrt{pr}$ 25Vdc or $\sqrt{pr}$ 75Vdc or $\sqrt{pr}$
Power Rating, Watts at 70°C	<b>BCN 102:</b> <b>BCN 4D:</b> <b>BCN 104:</b> <b>BCN 16 4A:</b> <b>BCN 16 8R/8S:</b> <b>BCN 21, BCN 31 8R/8S:</b>	63mW per Resistor / 125mW per Package 125mW per Resistor / 500mW per Package 63mW per Resistor / 125mW per Package 63mW per Resistor / 250mW per Package 32mW per Resistor / 250mW per Package 63mW per Resistor / 500mW per Package

## ENVIRONMENTAL

Operating Temperature Range		-55°C to +125°C
Temperature Coefficient of Resistance	<b>BCN 4D, BCN 16 8R/8S, BCN 21, BCN 31:</b> <b>BCN 102, BCN 104, BCN 16 4:</b>	±200ppm/°C ±250ppm/°C
Moisture Resistance		1,000 hours at +40°C, 95% R.H. (3.0%+0.1Ω ΔR)
High Temperature Operation		1,000 hours at 70°C (3.0%+0.1Ω ΔR)
Short Time Overload		2.5 x rated voltage, 5 seconds (2.0%+0.1Ω ΔR)
Temperature Cycling		-55°C to +125°C, 5 cycles (1.0%+0.1Ω ΔR)
Resistance to Solder Heat		260°C for 10 seconds (1.0%+0.1Ω ΔR)
Load Life		1,000 hours at 70°C (3.0%±0.1Ω ΔR)

## CONSTRUCTION

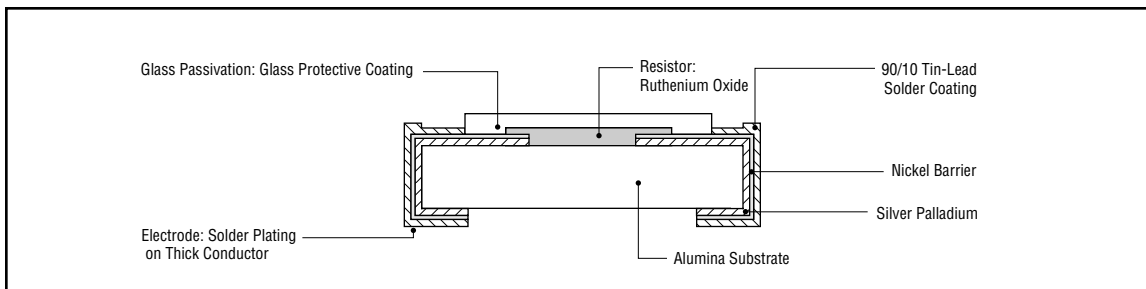

**SCHEMATICS**

**BCN 4D, BCN 104, & BCN 16 4**

**BCN 102**

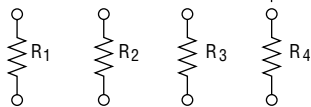

$$R_1 = R_2 \dots R_n$$

(n = 2,4)

**BCN 16 8R & BCN 31 8R**

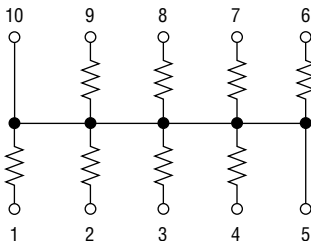

**BCN 16 8S & BCN 31 8S**

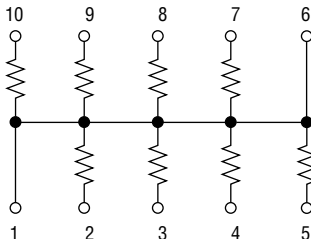

**BCN 21**

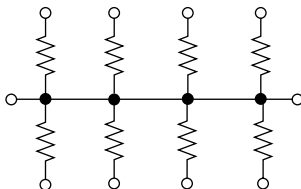

**STANDARD RESISTANCE VALUES, OHMS**

**Model BCN 102, BCN 4D, BCN 104 & BCN 16 4**

10	100	1K	10K	100K	1Meg
12	120	1.2K	12K	120K	Jumper
15	150	1.5K	15K	150K	
18	180	1.8K	18K	180K	
22	220	2.2K	22K	220K	
27	270	2.7K	27K	270K	
33	330	3.3K	33K	330K	
39	390	3.9K	39K	390K	
47	470	4.7K	47K	470K	
56	560	5.6K	56K	560K	
68	680	6.8K	68K	680K	
82	820	8.2K	82K	820K	

**Model BCN 16 8R & BCN 16 8S**

220	1K	10K	100K
330	4.7K	47K	1Meg

**Model BCN 31 8R**

**Model BCN 31 8S**

<b>220</b>	<b>2.2K</b>	<b>10K</b>	<b>100K</b>
<b>330</b>	<b>2.7K</b>	<b>22K</b>	<b>470K</b>
<b>1K</b>	<b>4.7K</b>	<b>47K</b>	<b>1Meg</b>

**Model BCN 21**

68	330	4.7K	10K
220	1K	47K	100K

**4**

**OUTLINE DIMENSIONS (Inch/mm)**

**Exterior Termination (Convex)**

**Scalloped Edge: Models BCN 4D, BCN 16 4A**

**Square Edge: Models BCN 4D, BCN 104, BCN 16 4AB, BCN 31**

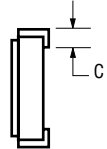
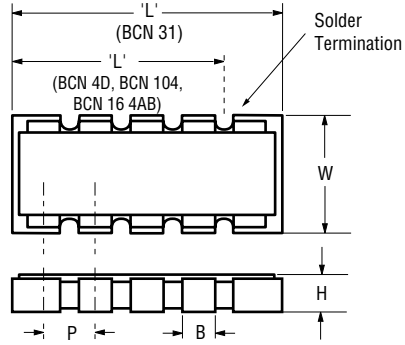
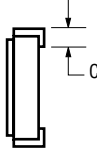
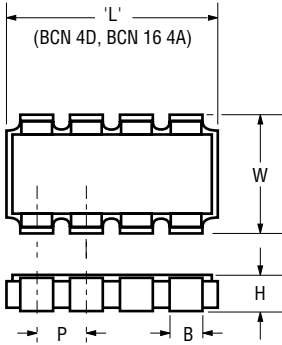

	L	W	H	P	B	C
<b>BCN 4D</b>	.210±.008 5.34±0.20	.122±.008 3.10±0.20	.022±.004 0.55±0.10	.050±.008 1.27±0.20	.030±.008 0.80±0.20	.012±.008 0.30±0.20
<b>BCN 104</b>	.079±.008 2.00±0.20	.039±.006 1.00±0.15	.014±.004 0.35±0.10	.020±.006 0.50±0.15	.012±.006 0.30±0.15	.010±.004 0.25±0.10
<b>BCN 16 4A &amp; AB</b>	.126±.004 3.2±0.10	.063±.004 1.60±0.10	.020±.004 0.50±0.10	.031±.002 0.80±0.05	.020±.004 0.50±0.10	.009±.005 0.229±0.127
<b>BCN 31</b>	.252±.004 6.40±0.20	.122±.004 3.10±0.20	.022±.004 0.55±0.10	.050±.002 1.27±0.051	.032±.004 0.80±0.10	.012±.004 0.30±0.10

**Interior Termination (Concave)**

**Square Edge: Models BCN 4 DBI, BCN 16 4ABI, BCN 31**

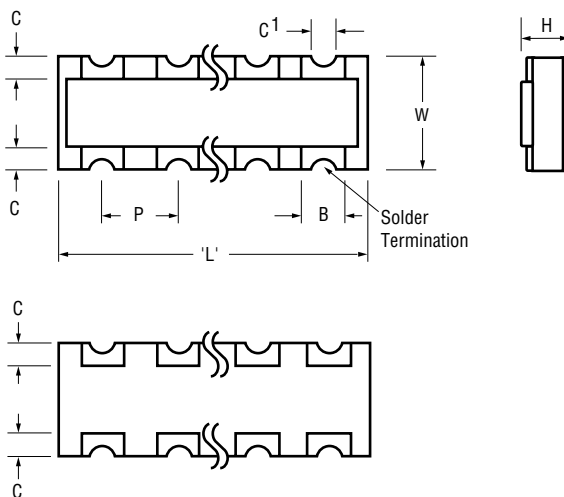

	L	W	H	P	B	C	C <sup>1</sup>
<b>BCN 4 DBI</b>	.210±.008 5.34±0.20	.122±.008 3.10±0.20	.022±.004 0.55±0.10	.050±.008 1.27±0.20	.030±.008 0.80±0.20	.012±.008 0.30±0.20	
<b>BCN 16 4ABI</b>	.126±.008 3.20±0.20	.063±.006 1.60±0.15	.024±.004 0.60±0.10	.031±.004 0.8±0.10	.016±.006 0.40±0.15	.012±.008 0.30±0.20	.012±.008 0.30±0.20
<b>BCN 31</b>	.252±.008 6.40±0.20	.122±.008 3.10±0.20	.024±.004 0.6±0.10	.050 1.27	.028±.008 0.70±0.20	.012 0.30	.012 <sup>+.008</sup> -.004 0.30 <sup>+.02</sup> -.01

**OUTLINE DIMENSIONS (Inch/mm)**

**Exterior Termination (Convex)**

**Square Edge: Model BCN 16 8R, BCN 16 8S**

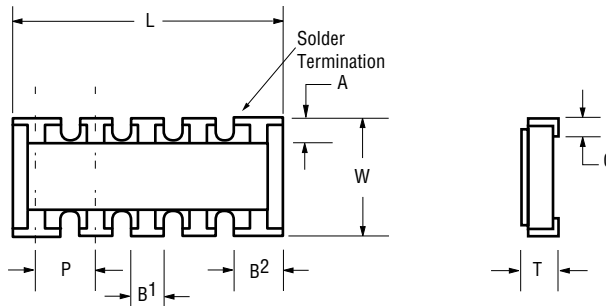

L	W	T	A	B <sup>1</sup>	B <sup>2</sup>	C	P
.126±.008 3.2±0.20	.063±.008 1.60±0.20	.020±.004 0.50±0.10	.012±.006 0.30±0.15	.014±.006 0.36±0.15	.020±.006 0.50±0.15	.008 0.2	.025 0.64

**Exterior Termination (Convex)**

**Square Edge: Model BCN 102**

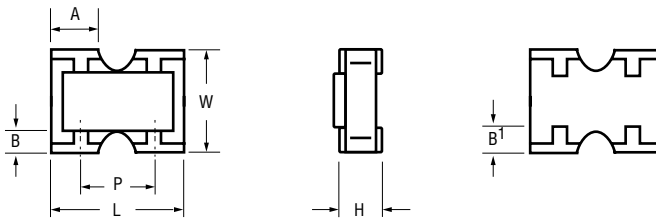

	L	W	H	A	B	B <sup>1</sup>	P
<b>BCN 102</b>	.039±.004 1.00±0.10	.039±.004 1.00±0.10	.014±.002 0.35±0.05	.013±.002 .33±0.05	.006 0.15	.010±.002 0.25±0.05	.026 0.65

**OUTLINE DIMENSIONS (Inch/mm)**

**Interior Termination (Concave)**

**Square Edge: Model BCN 21**

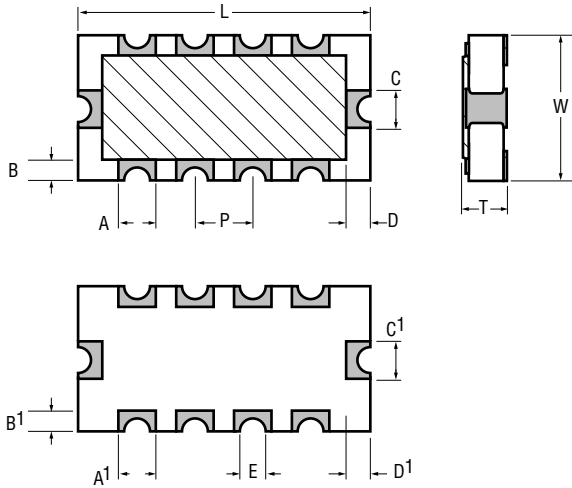

L	W	T	A	B	C	D
.157±.008 4.00±0.20	.083±.008 2.10±0.20	.024±.004 0.60±0.10	.020±.008 0.50±0.20	.010±.008 0.25±0.20	.020±.008 0.50±0.20	.012±.008 0.30±0.20
A1	B1	c1	D1	E	P	
.016±.008 0.40±0.20	.016±.008 0.40±0.20	.020±.008 0.50±0.20	.014±.008 0.35±0.20	.012 0.30 Typ.	.031 0.80 Typ.	

**SOLDER PAD LAYOUT (Inch/mm)**

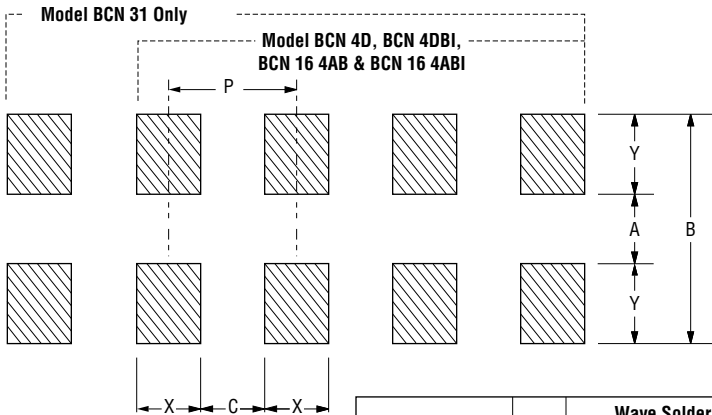

	P	Wave Solder Process					Re-Flow Solder Process				
		A	B	C	X	Y	A	B	C	X	Y
<b>BCN 4D/4DBI</b>	.050 1.27	.087 2.20	.169 4.30	.022 0.57	.028 0.70	.041 1.05	.087 2.20	.154 3.90	.022 0.57	.028 0.70	.034 0.85
<b>BCN16 4A/AB/ABI</b>	.032 0.80	.039 1.00	.118 3.00	.014 0.35	.018 0.45	.039 1.00	.039 1.00	.118 3.00	.014 0.35	.018 0.45	.039 1.00
<b>BCN 31 8R/8S</b>	.050 1.27	.084 2.10	.148 3.70	.014 0.35	.036 0.90	.032 0.80	.084 2.10	.148 3.70	.014 0.35	.036 0.90	.032 0.80

**Model BCN 16 8RB & BCN 16 8SB**

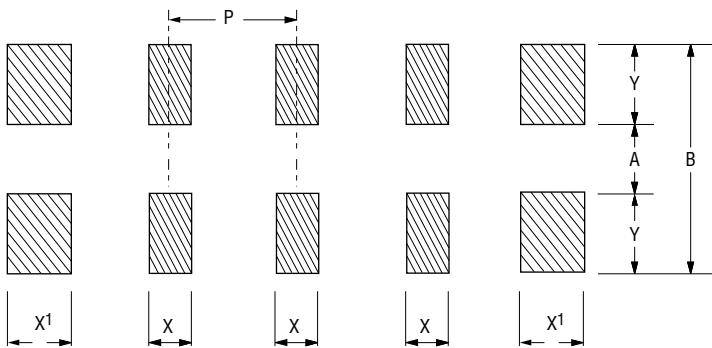

	P	Wave Solder Process					Re-Flow Solder Process				
		A	B	X	X <sup>1</sup>	Y	A	B	X	X <sup>1</sup>	Y
<b>BCN 16 8RB/8SB</b>	.025 0.64	.048 1.20	.096 2.40	.012 0.30	.018 0.45	.024 0.60	.048 1.20	.096 2.40	.012 0.30	.018 0.45	.024 0.60



**SOLDER PAD LAYOUT (Inch/mm)**

**Model BCN 102**

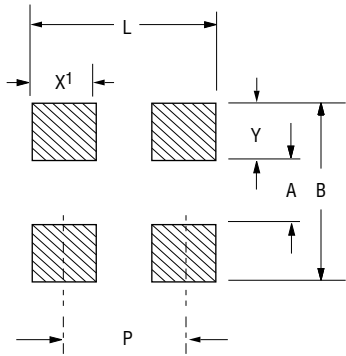

**Model BCN 104**

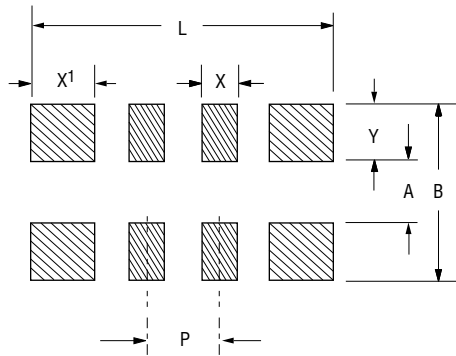

	P	A	B	X	$X^1$	Y	L
<b>BCN 102</b>	$\frac{.026}{0.65}$	$\frac{.020}{0.50}$	$\frac{.059}{1.50}$	NA	$\frac{.018}{0.45}$	$\frac{.020}{0.50}$	$\frac{.044}{1.10}$
<b>BCN 104</b>	$\frac{.020}{0.50}$	$\frac{.020}{0.50}$	$\frac{.059}{1.50}$	$\frac{.010}{0.25}$	$\frac{.018}{0.45}$	$\frac{.020}{0.50}$	$\frac{.085}{2.15}$

**Model BCN 21**

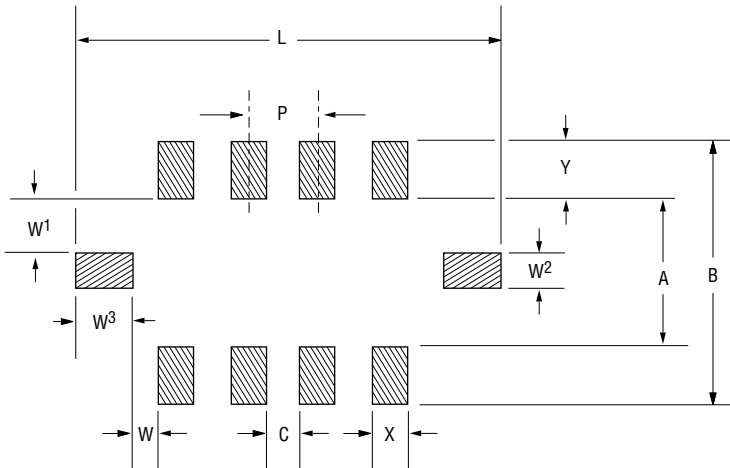

	P	A	B	C	X	Y	W	$W^1$	$W^2$	$W^3$	L
<b>BCN 21</b>	$\frac{.031}{0.80}$	$\frac{.059}{1.50}$	$\frac{.118}{3.00}$	$\frac{.016}{0.40}$	$\frac{.016}{0.40}$	$\frac{.030}{0.75}$	$\frac{.012}{0.30}$	$\frac{.020}{0.50}$	$\frac{.020}{0.50}$	$\frac{.030}{0.75}$	$\frac{.193}{4.90}$

**4**

## ORDERING INFORMATION

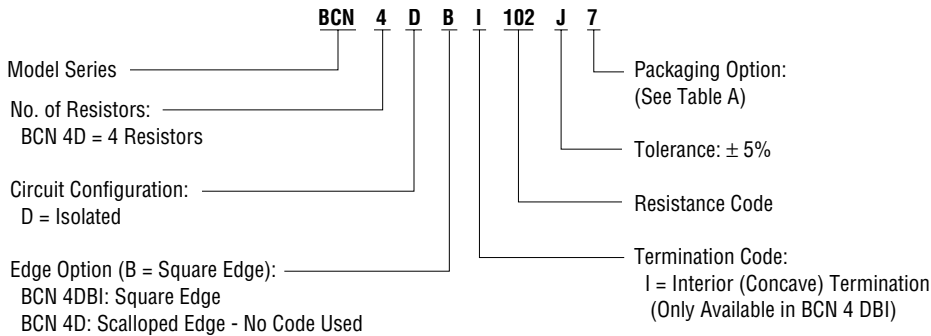

### See 'Model Styles' for Available Options

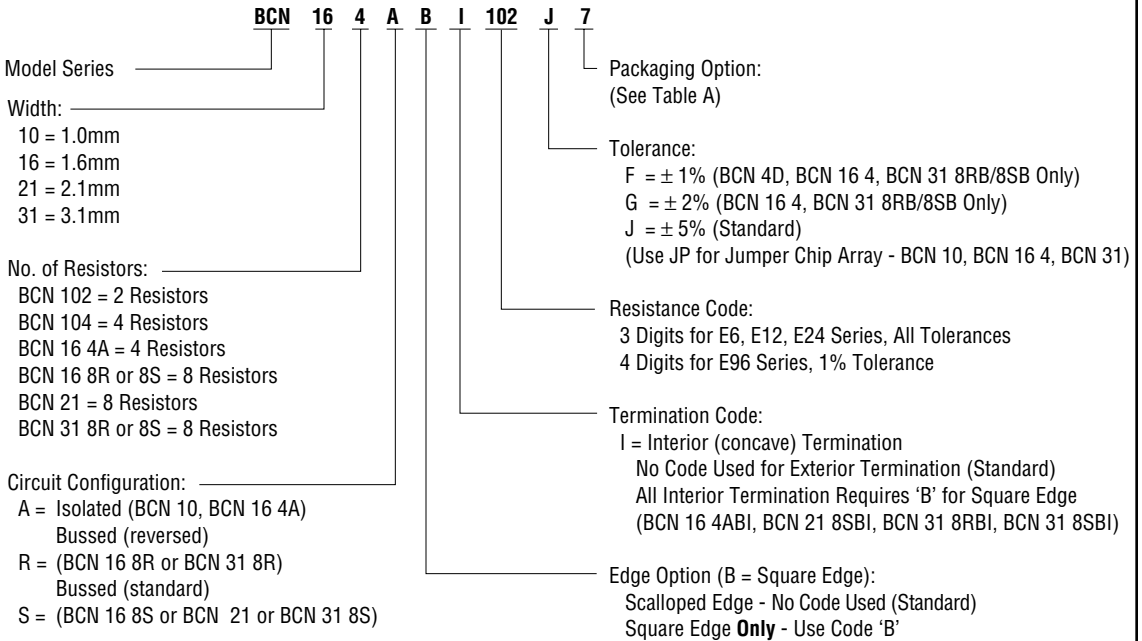

Table A	7" Reel Diameter		13" Reel Diameter	
	Paper	Embossed	Paper	Embossed
<b>BCN 10 2</b>	10K		40K	
<b>BCN 4D</b>		4K		16K
<b>BCN 10 4</b>	10K		40K	
<b>BCN 16 4</b>	5K		20K	
<b>BCN 16 8</b>	5K		20K	
<b>BCN 21</b>		4K		16K
<b>BCN 31</b>		4K		16K

### See 'Model Styles' for Available Options.

Note: Tape & Reel Dimensions per EIA-481.