

Stereo DAC For Portable Audio Applications

DESCRIPTION

The WM8751L is a low power, high quality stereo DAC with integrated headphone and loudspeaker amplifiers, designed to reduce external component requirements in portable digital audio applications.

The on-chip headphone amplifiers can deliver 40mW into a 16Ω load. Advanced on-chip digital signal processing performs bass and treble tone control.

The WM8751L can operate as a master or a slave, with various master clock frequencies including 12 or 24MHz for USB devices or standard 256f_s rates like 12.288MHz and 24.576MHz. Different audio sample rates such as 96kHz, 48kHz, 44.1kHz are generated directly from the master clock without the need for an external PLL.

The WM8751L operates on supply voltages from 1.8V up to 3.6V, although the digital core can operate on a separate supply down to 1.42V, saving power. Different sections of the chip can also be powered down under software control.

The WM8751L is supplied in a very small and thin 5x5mm QFN package, ideal for use in hand-held and portable systems.

FEATURES

- DAC SNR 98dB, THD -86dB ('A' weighted @ 48kHz, 3.3V)
- On-chip 400mW BTL Speaker Driver (mono)
- On-chip Headphone Driver
 - 40mW output power on 16Ω / 3.3V
 - SNR 96dB, THD -79dB at 20mW with 16Ω load
- Stereo and Mono Line-in mix into DAC output
- Separately Mixed Stereo and Mono Outputs
- Digital Tone Control and Bass Boost
- Low Power
 - Down to 7mW for stereo playback (1.8V / 1.5V supplies)
 - 10μW Shutdown Mode
- Low Supply Voltages
 - Analogue and Digital I/O: 1.8V to 3.6V
 - Digital core: 1.42V to 3.6V
- 256fs / 384fs or USB master clock rates: 12MHz, 24MHz
- Audio sample rates: 8, 11.025, 12, 16, 22.05, 24, 32, 44.1, 48, 88.2, 96kHz generated internally from master clock
- 32-lead QFN package, 5x5x0.9mm size, 0.5mm lead pitch

APPLICATIONS

- Digital Audio Player
- MP3 Phone
- Minidisc Player

BLOCK DIAGRAM

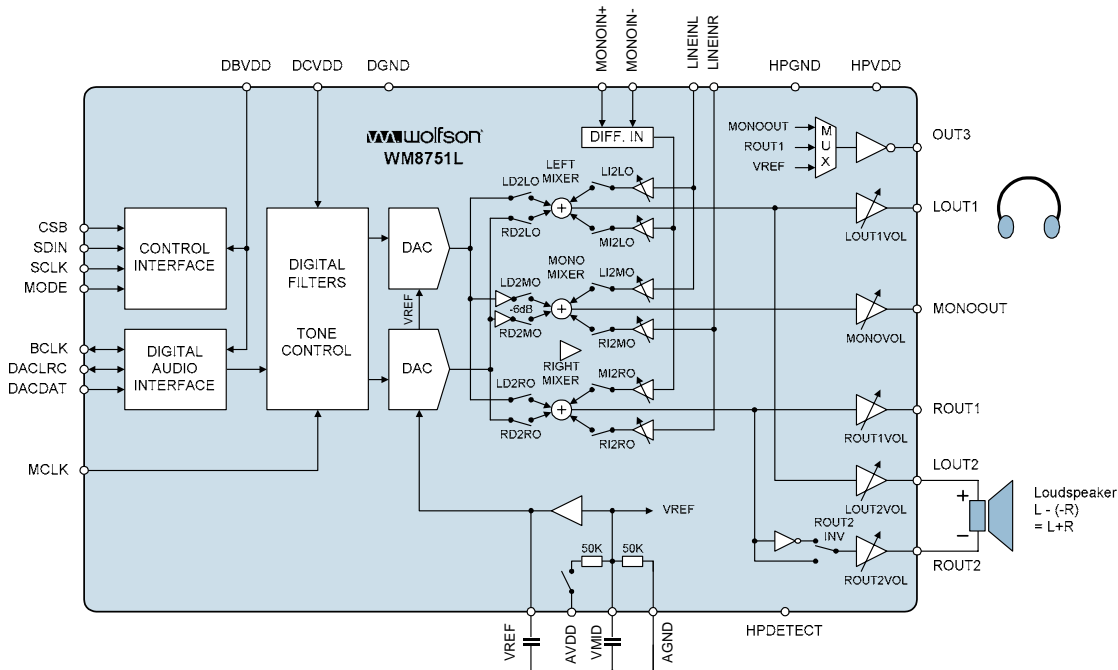
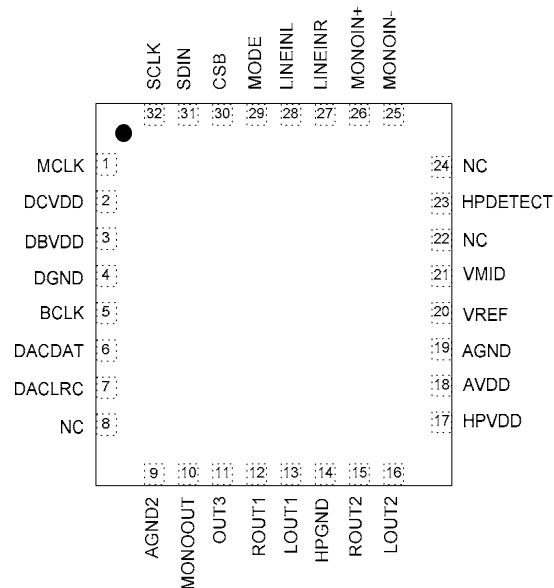

TABLE OF CONTENTS

DESCRIPTION	1
FEATURES	1
APPLICATIONS	1
BLOCK DIAGRAM	1
TABLE OF CONTENTS	2
PIN CONFIGURATION	3
ORDERING INFORMATION	3
ABSOLUTE MAXIMUM RATINGS	5
RECOMMENDED OPERATING CONDITIONS	5
ELECTRICAL CHARACTERISTICS	6
TERMINOLOGY.....	7
OUTPUT PGA'S LINEARITY	8
SIGNAL TIMING REQUIREMENTS	11
SYSTEM CLOCK TIMING.....	11
AUDIO INTERFACE TIMING – MASTER MODE	11
AUDIO INTERFACE TIMING – SLAVE MODE	13
CONTROL INTERFACE TIMING – 3-WIRE MODE	13
CONTROL INTERFACE TIMING – 2-WIRE MODE	14
INTERNAL POWER ON RESET CIRCUIT	15
DEVICE DESCRIPTION	16
INTRODUCTION.....	16
SIGNAL PATH	16
LINE INPUTS AND OUTPUT MIXERS	20
ANALOGUE OUTPUTS	23
DIGITAL AUDIO INTERFACE.....	27
MASTER CLOCK AND AUDIO SAMPLE RATES	32
POWER SUPPLIES	35
POWER MANAGEMENT	36
REGISTER MAP	38
DIGITAL FILTER CHARACTERISTICS	39
TERMINOLOGY.....	39
DAC FILTER RESPONSES	39
APPLICATIONS INFORMATION	41
RECOMMENDED EXTERNAL COMPONENTS.....	41
MINIMISING POP NOISE AT THE ANALOGUE OUTPUTS	42
LINE OUTPUT CONFIGURATION.....	42
HEADPHONE OUTPUT CONFIGURATION	43
SPEAKER OUTPUT CONFIGURATION	43
PACKAGE DIMENSIONS	44
IMPORTANT NOTICE	45
ADDRESS:.....	45

PIN CONFIGURATION



ORDERING INFORMATION

ORDER CODE	TEMPERATURE RANGE	PACKAGE	MOISTURE SENSITIVITY LEVEL	PEAK SOLDERING TEMPERATURE
WM8751LSEFL	-25°C to +85°C	32-lead QFN (5x5x0.9mm) (Pb-free)	MSL1	260°C
WM8751LSEFL/R	-25°C to +85°C	32-lead QFN (5x5x0.9mm) (Pb-free, tape and reel)	MSL1	260°C

Note:

Reel quantity = 3,500

PIN DESCRIPTION

PIN NO	NAME	TYPE	DESCRIPTION
1	MCLK	Digital Input	Master Clock
2	DCVDD	Supply	Digital Core Supply
3	DBVDD	Supply	Digital Buffer (I/O) Supply
4	DGND	Supply	Digital Ground (return path for both DCVDD and DBVDD)
5	BCLK	Digital Input / Output	Audio Interface Bit Clock
6	DACDAT	Digital Input	DAC Digital Audio Data
7	DACLRC	Digital Input / Output	Audio Interface Left / Right Clock
8	NC	No Connect	Leave this pin unconnected
9	AGND2	Supply	Internally connected to AGND. Leave this pin floating or connect to AGND.
10	MONOOUT	Analogue Output	Mono Output
11	OUT3	Analogue Output	Output 3 (can be used as Headphone Pseudo Ground)
12	ROUT1	Analogue Output	Right Output 1 (Line or Headphone)
13	LOUT1	Analogue Output	Left Output 1 (Line or Headphone)
14	HPGND	Supply	Supply for Analogue Output Drivers (LOUT1/2, ROUT1/2)
15	ROUT2	Analogue Output	Right Output 2 (Line or Headphone or Speaker)
16	LOUT2	Analogue Output	Left Output 2 (Line or Headphone or Speaker)
17	HPVDD	Supply	Supply for Analogue Output Drivers (LOUT1/2, ROUT1/2, MONOOUT)
18	AVDD	Supply	Analogue Supply
19	AGND	Supply	Analogue Ground (return path for AVDD)
20	VREF	Analogue Output	Reference Voltage Decoupling Capacitor
21	VMID	Analogue Output	Midrail Voltage Decoupling Capacitor
22	NC	No Connect	No Internal Connection
23	HPDETECT	Logic Input	Headphone / Speaker switch (referred to AVDD)
24	NC	No Connect	No Internal Connection
25	MONOIN-	Analogue Input	Negative end of MONOIN+, for differential mono signals
26	MONOIN+	Analogue Input	Analogue Line-in to mixers (mono channel)
27	LINEINR	Analogue Input	Analogue Line-in to mixers (right channel)
28	LINEINL	Analogue Input	Analogue Line-in to mixers (left channel)
29	MODE	Digital Input	Control Interface Selection
30	CSB	Digital Input	Chip Select / Device Address Selection
31	SDIN	Digital Input/Output	Control Interface Data Input / 2-wire Acknowledge output
32	SCLK	Digital Input	Control Interface Clock Input

Note:

It is recommended that the QFN ground paddle should be connected to analogue ground on the application PCB.

ABSOLUTE MAXIMUM RATINGS

Absolute Maximum Ratings are stress ratings only. Permanent damage to the device may be caused by continuously operating at or beyond these limits. Device functional operating limits and guaranteed performance specifications are given under Electrical Characteristics at the test conditions specified.



ESD Sensitive Device. This device is manufactured on a CMOS process. It is therefore generically susceptible to damage from excessive static voltages. Proper ESD precautions must be taken during handling and storage of this device.

Wolfson tests its package types according to IPC/JEDEC J-STD-020B for Moisture Sensitivity to determine acceptable storage conditions prior to surface mount assembly. These levels are:

MSL1 = unlimited floor life at <30°C / 85% Relative Humidity. Not normally stored in moisture barrier bag.

MSL2 = out of bag storage for 1 year at <30°C / 60% Relative Humidity. Supplied in moisture barrier bag.

MSL3 = out of bag storage for 168 hours at <30°C / 60% Relative Humidity. Supplied in moisture barrier bag.

The Moisture Sensitivity Level for each package type is specified in Ordering Information.

CONDITION	MIN	MAX
Supply voltages	-0.3V	+3.63V
Voltage range digital inputs	DGND -0.3V	DBVDD +0.3V
Voltage range analogue inputs	AGND -0.3V	AVDD +0.3V
Operating temperature range, T _A	-25°C	+85°C
Storage temperature after soldering	-65°C	+150°C

Notes:

1. Analogue and digital grounds must always be within 0.3V of each other.
2. All digital and analogue supplies are completely independent from each other.

RECOMMENDED OPERATING CONDITIONS

PARAMETER	SYMBOL	TEST CONDITIONS	MIN	TYP	MAX	UNIT
Digital supply range (Core)	DCVDD		1.42		3.6	V
Digital supply range (Buffer)	DBVDD		1.8		3.6	V
Analogue supplies range	AVDD, HPVDD		1.8		3.6	V
Ground	DGND, AGND, HPGND			0		V

ELECTRICAL CHARACTERISTICS

Test Conditions

DCVDD = 1.5V, AVDD = HPVDD = 3.3V, T_A = +25°C, 1kHz signal, f_s = 48kHz, 24-bit audio data unless otherwise stated.

PARAMETER	SYMBOL	TEST CONDITIONS	MIN	TYP	MAX	UNIT
DAC to Line-Out (L/ROUT1 with 10kΩ / 50pF load)						
Signal to Noise Ratio (A-weighted)	SNR	AVDD = 3.3V		98		dB
		AVDD = 1.8V		95		
Total Harmonic Distortion	THD	AVDD = 3.3V		-86		dB
		AVDD = 1.8V		-82		
Channel Separation		1kHz signal		100		dB
Analogue Mixer Inputs (LINEINL/R to L/ROUT1 with 10kΩ / 50pF load)						
Full-scale Input Signal Level	V _{INFS}	AVDD = 3.3V		1.0		V _{rms}
		AVDD = other		AVDD/3.3		
Signal to Noise Ratio Line-in to Line-Out (A-weighted)	SNR	AVDD = 3.3V		98		dB
		AVDD = 1.8V		95		
Total Harmonic Distortion	THD	AVDD = 3.3V		-94		dB
		AVDD = 1.8V		-90		
Input Resistance (signal enters one mixer only)	R _{LINEIN}	PGA gain = 0dB		20.5		kΩ
		PGA gain = +6dB		10.5		
Input Resistance (signal enters two mixers)		PGA gain = 0dB		10.25		
		PGA gain = +6dB		5.25		
MONOIN- input resistance	R _{MONOIN-}	any gain		20		kΩ
Common mode rejection ratio	CMRR	MONOIN+ / MONOIN- to L/ROUT1, 20Hz–20kHz		-38		dB
Mute Attenuation				-91		dB
Analogue Outputs (LOUT1/2, ROUT1/2, MONOOUT)						
0dB Full scale output voltage				AVDD/3.3		V _{rms}
Mute attenuation		1kHz, full scale signal		-94		dB
Channel Separation				-91		dB
Headphone Output (LOUT1/2, ROUT1/2 with 16 or 32Ω load)						
Output Power per channel	P _O	Output power is very closely correlated with THD; see below.				
Total Harmonic Distortion	THD	HPVDD=1.8V, R _L =32Ω P _O =5mW		0.018 -75		dB %
		HPVDD=1.8V, R _L =16Ω P _O =5mW		0.025 -72		
		HPVDD=3.3V, R _L =32Ω, P _O =20mW		0.013 -78		
		HPVDD=3.3V, R _L =16Ω, P _O =20mW		0.011 -79		
Signal to Noise Ratio (A-weighted)	SNR	HPVDD = 3.3V	92	96		dB
		HPVDD = 1.8V		95		
Speaker Output (LOUT2/ROUT2 with 8Ω bridge tied load, ROUT2INV=1)						
Output Power at 1% THD	P _O	THD = 1%		330		mW (rms)
Abs. Max Power Output	P _{Omax}			500		mW (rms)
Total Harmonic Distortion	THD	P _O =200mW, R _L =8Ω, HPVDD=3.3V		-63 0.07		dB %
Signal to Noise Ratio (A-weighted)	SNR	HPVDD=3.3V, R _L =8Ω		95		dB
Analogue Reference Levels						
Midrail Reference Voltage	VMID		-3%	AVDD/2	+3%	V
Buffered Reference Voltage	VREF		-3%	AVDD/2	+3%	V

Test Conditions

DCVDD = 1.5V, AVDD = HPVDD = 3.3V, T_A = +25°C, 1kHz signal, fs = 48kHz, 24-bit audio data unless otherwise stated.

PARAMETER	SYMBOL	TEST CONDITIONS	MIN	TYP	MAX	UNIT
Digital Input / Output						
Input HIGH Level	V _{IH}		0.7×DBVDD			V
Input LOW Level	V _{IL}				0.3×DBVDD	V
Output HIGH Level	V _{OH}	I _{OH} = 1mA	0.9×DBVDD			V
Output LOW Level	V _{OL}	I _{OL} = -1mA			0.1×DBVDD	V

TERMINOLOGY

1. Signal-to-noise ratio (dB) - SNR is a measure of the difference in level between the full scale output and the output with no signal applied. (No Auto-zero or Automute function is employed in achieving these results).
2. Dynamic range (dB) - DR is a measure of the difference between the highest and lowest portions of a signal. Normally a THD+N measurement at 60dB below full scale. The measured signal is then corrected by adding the 60dB to it. (e.g. THD+N @ -60dB= -32dB, DR= 92dB).
3. THD+N (dB) - THD+N is a ratio, of the rms values, of (Noise + Distortion)/Signal.
4. Channel Separation (dB) - Also known as Cross-Talk. This is a measure of the amount one channel is isolated from the other. Normally measured by sending a full scale signal down one channel and measuring the other.

OUTPUT PGA'S LINEARITY

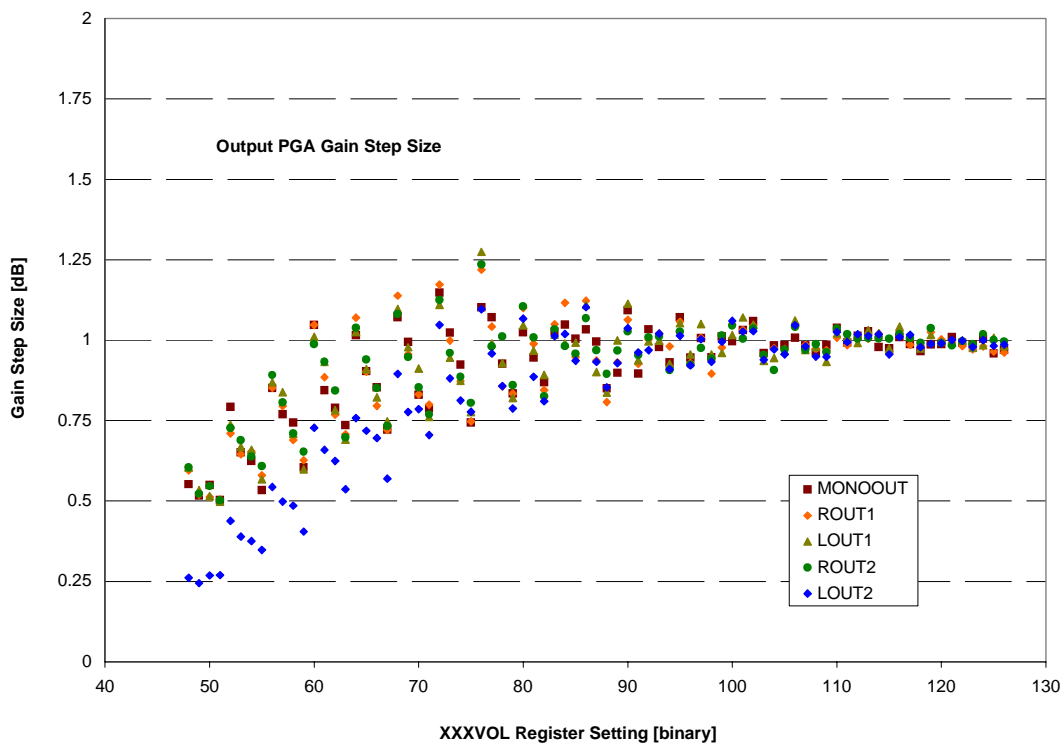
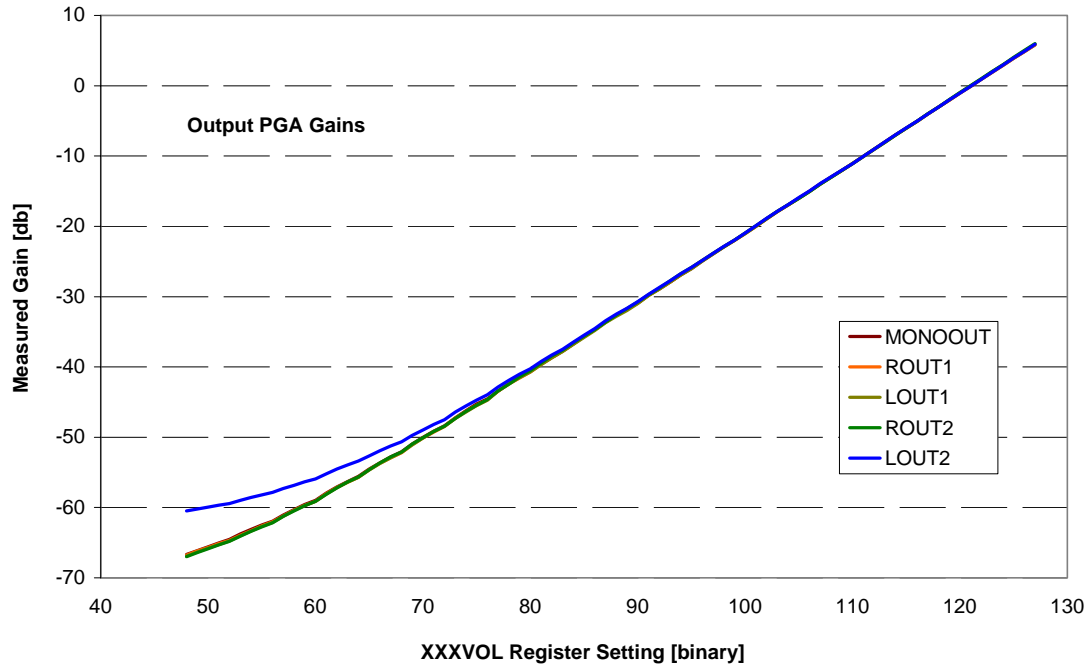

HEADPHONE OUTPUT THD VERSUS POWER

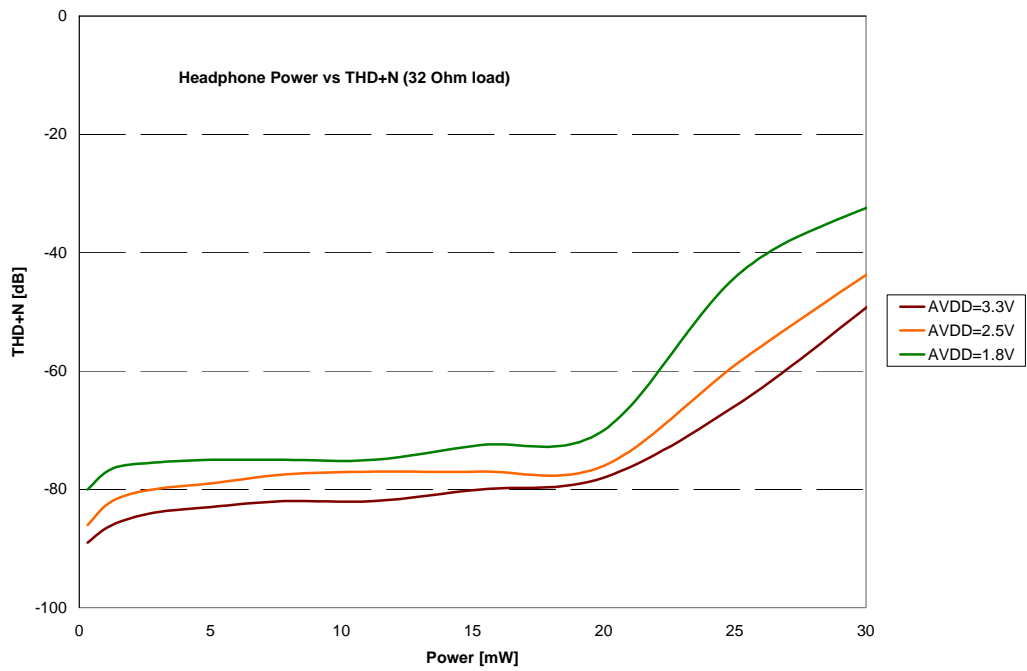
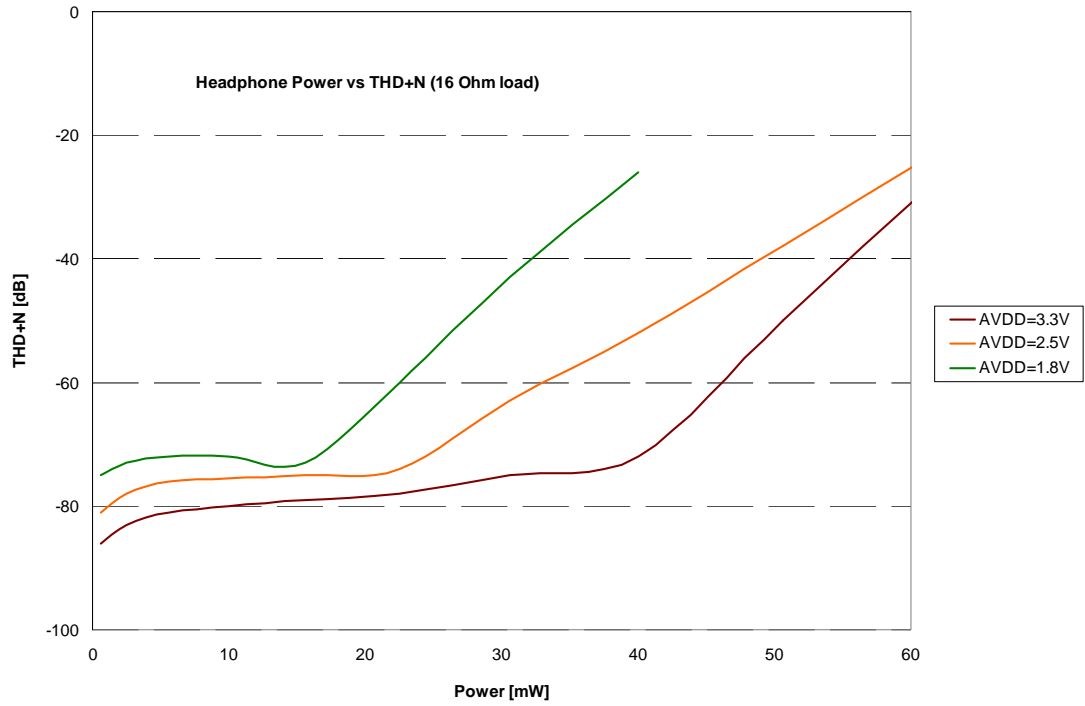

POWER CONSUMPTION

The power consumption of the WM8751L depends on the following factors.

- Supply voltages: Reducing the supply voltages also reduces supply currents, and therefore results in significant power savings.
- Operating mode: Power consumption is lower in mono modes than in stereo, as one DAC is switched OFF. Unused analogue outputs should be switched off.

Control Register	R25		R26 (1Ah)							R24	R23	R38	Other settings	AVDD		DCVDD		DBVDD		HPVDD		Tot. Power (mW)
	VMIDSEL	VREF	DACL	DACR	LOUT1	ROUT1	LOUT2	ROUT2	MONO	OUT3	DACOSR	VSEL		DMEN	V	I (mA)	V	I (mA)	V	I (mA)	V	
OFF	00	0	0	0	0	0	0	0	0	0	11	0	Clocks stopped	3.3	0.0001	3.3	0.0103	3.3	0	3.3	0	0.03432
Low-power standby (LPS) using 500 KOhm VMID string	10	1	0	0	0	0	0	0	0	0	11	0		2.5	0.0001	2.5	0.0084	2.5	0	2.5	0	0.02125
														1.8	0.0001	1.5	0.0067	1.5	0	1.8	0	0.01023
														3.3	0.2339	3.3	0.409	3.3	0.0856	3.3	0	2.40405
Playback to Line-out	01	1	1	1	0	0	1	1	0	0	11	0		2.5	0.1737	2.5	0.2556	2.5	0.0616	2.5	0	1.22725
														1.8	0.1208	1.5	0.1416	1.5	0.035	1.8	0	0.48234
														3.3	3.9903	3.3	5.1104	3.3	0.0878	3.3	0.6621	32.50698
Playback to Line-out (64x oversampling mode)	01	1	1	1	0	0	1	1	0	1	11	0		2.5	2.9459	2.5	3.5193	2.5	0.0632	2.5	0	17.95925
														1.8	2.0701	1.5	1.9742	1.5	0.036	1.8	0.3845	7.43358
														3.3	3.7821	3.3	4.2678	3.3	0.0879	3.3	0.6619	31.73445
Playback to 16 Ohm headphone using caps on HPOUTL/R	01	1	1	1	1	1	0	0	0	0	11	0		2.5	2.7924	2.5	2.9224	2.5	0.0632	2.5	0.6557	16.08425
														1.8	1.9604	1.5	1.6299	1.5	0.036	1.8	0.3847	6.72003
														3.3	3.9623	3.3	5.0846	3.3	0.0878	3.3	0.6913	29.73036
Playback to 16 Ohm headphone capless mode using OUT3	01	1	1	1	1	1	0	0	1	0	11	0	R24, OUT3SW=00	2.5	2.999	2.5	3.557	2.5	0.064	2.5	1.167	19.4675
													1.8	2.0705	1.5	1.9164	1.5	0.0356	1.8	0.914	8.8857	
													3.3	4.0662	3.3	5.1007	3.3	0.0881	3.3	1.172	34.4091	
Playback to 8 Ohm BTL speaker	01	1	1	1	0	0	1	1	0	0	11	0	R24, ROUT2INV=1	2.5	3.1282	2.5	3.5487	2.5	0.0639	2.5	0.8039	18.86175
													1.8	2.1565	1.5	1.9671	1.5	0.0358	1.8	0.6698	8.09169	
													3.3	3.9602	3.3	4.2714	3.3	0.0873	3.3	0.8068	30.11481	
Headphone Amp line-in to 16 Ohm h/phone	01	1	0	0	1	0	0	0	0	0	11	0	Clocks stopped	3.3	1.7135	3.3	0.0901	3.3	0	3.3	0.6624	8.1378
													2.5	1.211	2.5	0.009	2.5	0	2.5	0.6291	4.62275	
													1.8	0.8017	1.5	0.0071	1.5	0	1.8	0.3869	2.15013	
Speaker Amp line-in to 8 Ohm speaker	01	1	0	0	0	1	1	0	0	0	11	0	R24, ROUT2INV=1	3.3	1.7132	3.3	0.0905	3.3	0	3.3	1.158	9.77361
													2.5	1.2631	2.5	0.009	2.5	0	2.5	1.0804	5.88125	
													1.8	0.8881	1.5	0.0071	1.5	0	1.8	0.8733	3.18117	
Phone Call diff. mono line-in to h/phone, diff. mono line-out to TX	01	1	0	0	1	0	0	1	1	0	11	1	Clocks stopped	3.3	1.9574	3.3	0.0905	3.3	0	3.3	1.1675	10.61082
													2.5	1.4258	2.5	0.009	2.5	0	2.5	1.1017	6.34125	
													1.8	0.9076	1.5	0.0071	1.5	0	1.8	0.6576	2.82801	
Maximum Power everything ON	01	1	1	1	1	1	1	1	1	0	11	1	R24, ROUT2INV=1	3.3	4.3644	3.3	5.2975	3.3	0.089	3.3	1.832	38.22357
													2.5	3.2234	2.5	3.6609	2.5	0.0643	2.5	1.7821	21.82675	
													1.8	2.2443	1.5	2.002	1.5	0.0357	1.8	1.1289	9.12831	

Table 1 Supply Current Consumption

Notes:

- $T_A = +25^{\circ}\text{C}$, Slave Mode, $f_s = 48\text{kHz}$, $\text{MCLK} = 12.288\text{ MHz}$ (256fs), 24-bit data
- All figures are quiescent, with no signal.
- The power dissipated in the headphone itself is not included in the above table.

SIGNAL TIMING REQUIREMENTS

SYSTEM CLOCK TIMING

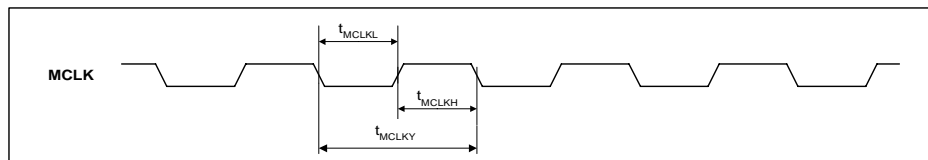

Figure 1 System Clock Timing Requirements

Test Conditions

CLKDIV2=0, DCVDD = 1.42V, DBVDD = 3.3V, DGND = 0V, T_A = +25°C, Slave Mode fs = 48kHz, MCLK = 384fs, 24-bit data, unless otherwise stated.

PARAMETER	SYMBOL	MIN	TYP	MAX	UNIT
System Clock Timing Information					
MCLK System clock pulse width high	T _{MCLKL}	21			ns
MCLK System clock pulse width low	T _{MCLKH}	21			ns
MCLK System clock cycle time	T _{MCLKY}	54			ns
MCLK duty cycle	T _{MCLKDS}	60:40		40:60	

Test Conditions

CLKDIV2=1, DCVDD = 1.42V, DBVDD = 3.3V, DGND = 0V, T_A = +25°C, Slave Mode fs = 48kHz, MCLK = 384fs, 24-bit data, unless otherwise stated.

PARAMETER	SYMBOL	MIN	TYP	MAX	UNIT
System Clock Timing Information					
MCLK System clock pulse width high	T _{MCLKL}	10			ns
MCLK System clock pulse width low	T _{MCLKH}	10			ns
MCLK System clock cycle time	T _{MCLKY}	27			ns

AUDIO INTERFACE TIMING – MASTER MODE

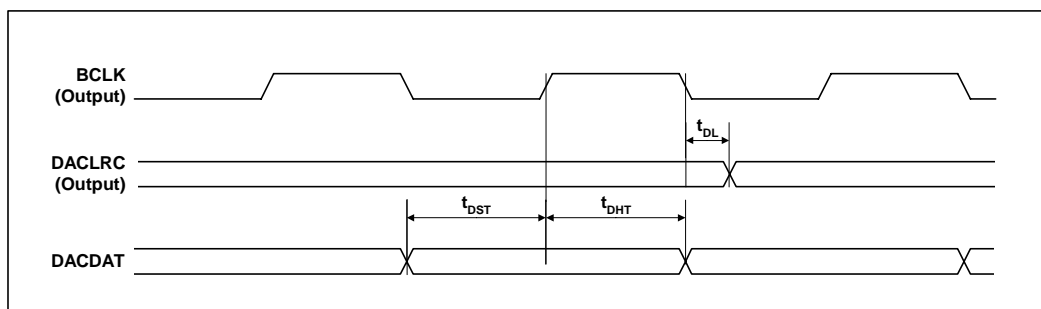

Figure 2 Digital Audio Data Timing – Master Mode (see Control Interface)

Test Conditions

DBVDD = 3.3V, DGND = 0V, T_A = +25°C, Slave Mode fs = 48kHz, MCLK = 256fs, 24-bit data, unless otherwise stated.

PARAMETER	SYMBOL	MIN	TYP	MAX	UNIT
Bit Clock Timing Information					
BCLK rise time (10pF load)	t _{BCLKR}			3	ns
BCLK fall time (10pF load)	t _{BCLKF}			3	ns
BCLK duty cycle (normal mode, BCLK = MCLK/n)	t _{BCLKDS}		50:50		
BCLK duty cycle (USB mode, BCLK = MCLK)	t _{BCLKDS}		T _{MCLKDS}		

Test ConditionsDBVDD = 3.3V, DGND = 0V, T_A = +25°C, Slave Mode f_s = 48kHz, MCLK = 256fs, 24-bit data, unless otherwise stated.

PARAMETER	SYMBOL	MIN	TYP	MAX	UNIT
System Clock Timing Information					
DACLRC propagation delay from BCLK falling edge	t _{DL}			10	ns
DACDAT setup time to BCLK rising edge	t _{DST}	10			ns
DACDAT hold time from BCLK rising edge	t _{DHT}	10			ns

AUDIO INTERFACE TIMING – SLAVE MODE

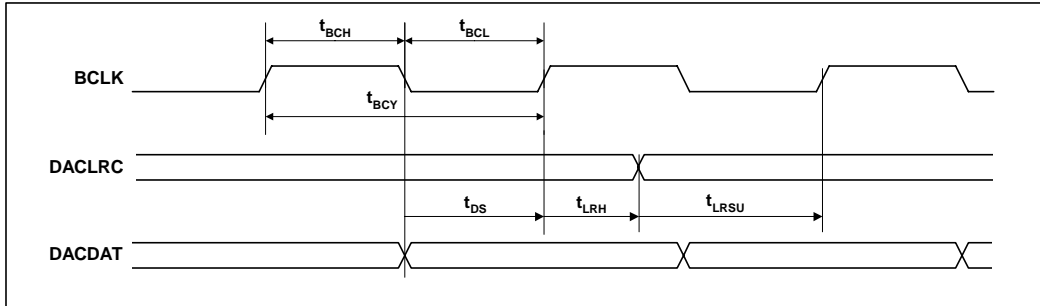

Figure 3 Digital Audio Data Timing – Slave Mode (see Control Interface)

Test Conditions

DBVDD = 3.3V, DGND = 0V, T_A = +25°C, Slave Mode fs = 48kHz, MCLK = 256fs, 24-bit data, unless otherwise stated.

PARAMETER	SYMBOL	MIN	TYP	MAX	UNIT
System Clock Timing Information					
BCLK cycle time	t _{BCY}	50			ns
BCLK pulse width high	t _{BCH}	20			ns
BCLK pulse width low	t _{BCL}	20			ns
DACLRC setup time to BCLK rising edge	t _{LRSU}	10			ns
DACLRC hold time from BCLK rising edge	t _{LRH}	10			ns
DACDAT hold time from BCLK rising edge	t _{DH}	10			ns

CONTROL INTERFACE TIMING – 3-WIRE MODE

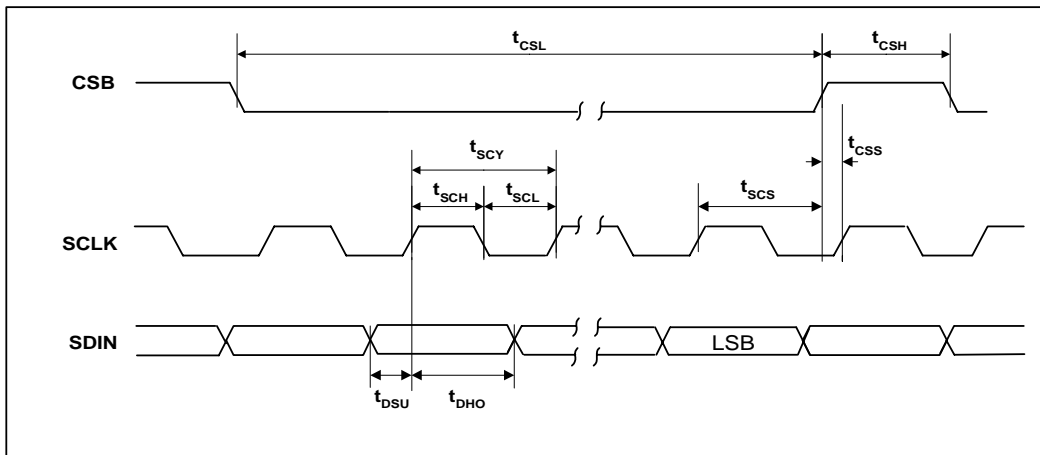

Figure 4 Control Interface Timing – 3-Wire Serial Control Mode

Test Conditions

DBVDD = 3.3V, DGND = 0V, $T_A = +25^\circ\text{C}$, Slave Mode, $f_s = 48\text{kHz}$, MCLK = 256fs, 24-bit data, unless otherwise stated.

PARAMETER	SYMBOL	MIN	TYP	MAX	UNIT
Program Register Input Information					
SCLK rising edge to CSB rising edge	t_{SCS}	500			ns
SCLK pulse cycle time	t_{SCY}	200			ns
SCLK pulse width low	t_{SCL}	80			ns
SCLK pulse width high	t_{SCH}	80			ns
SDIN to SCLK set-up time	t_{DSU}	40			ns
SCLK to SDIN hold time	t_{DHO}	40			ns
CSB pulse width low	t_{CSL}	40			ns
CSB pulse width high	t_{CSH}	40			ns
CSB rising to SCLK rising	t_{CSS}	40			ns
Pulse width of spikes that will be suppressed	t_{ps}	0		5	ns

CONTROL INTERFACE TIMING – 2-WIRE MODE

Figure 5 Control Interface Timing – 2-Wire Serial Control Mode

Test Conditions

DBVDD = 3.3V, DGND = 0V, $T_A = +25^\circ\text{C}$, Slave Mode, $f_s = 48\text{kHz}$, MCLK = 256fs, 24-bit data, unless otherwise stated.

PARAMETER	SYMBOL	MIN	TYP	MAX	UNIT
Program Register Input Information					
SCLK Frequency		0		526	kHz
SCLK Low Pulse-Width	t_1	1.3			ns
SCLK High Pulse-Width	t_2	600			us
Hold Time (Start Condition)	t_3	600			ns
Setup Time (Start Condition)	t_4	600			ns
Data Setup Time	t_5	100			ns
SDIN, SCLK Rise Time	t_6			300	ns
SDIN, SCLK Fall Time	t_7			300	ns
Setup Time (Stop Condition)	t_8	600			ns
Data Hold Time	t_9			900	ns
Pulse width of spikes that will be suppressed	t_{ps}	0		5	ns

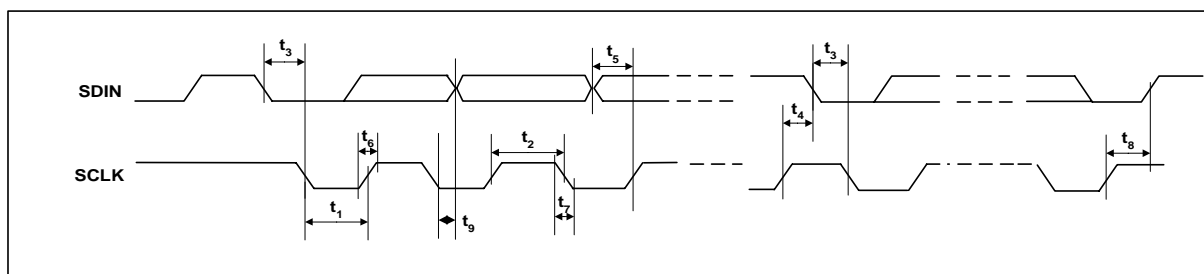
INTERNAL POWER ON RESET CIRCUIT

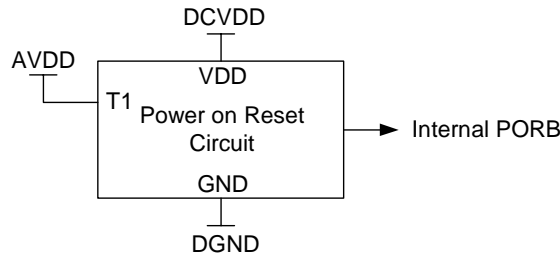

Figure 6 Internal Power on Reset Circuit Schematic

The WM8751 includes an internal Power-On-Reset Circuit, as shown in Figure 6, which is used to reset the digital logic into a default state after power up. The power on reset circuit is powered from DCVDD and monitors DCVDD and AVDD. It asserts PORB low if DCVDD or AVDD are below a minimum threshold.

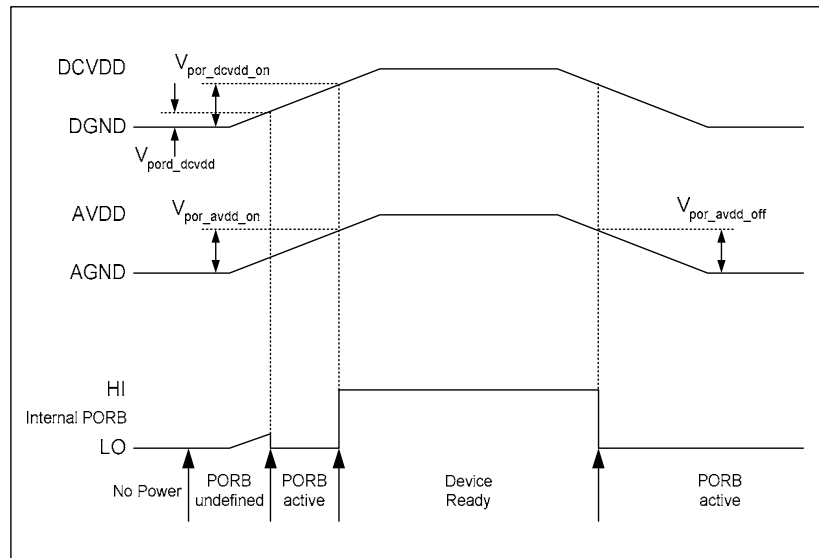

Figure 7 Typical Power-Up Sequence

Figure 7 shows a typical power-up sequence. When DCVDD and AVDD rise above the minimum thresholds, $V_{por_dcvgd_on}$ and $V_{por_avdd_on}$, there is enough voltage for the circuit to guarantee the Power on Reset is asserted low and the chip is held in reset. In this condition, all writes to the control interface are ignored. When DCVDD rises to $V_{por_dcvgd_on}$ and AVDD rises to $V_{por_avdd_on}$, PORB is released high and all registers are in their default state and writes to the control interface may take place. If DCVDD and AVDD rise at different rates then PORB will only be released when DCVDD and AVDD have both exceeded the $V_{por_dcvgd_on}$ and $V_{por_avdd_on}$ thresholds.

On power down, PORB is asserted low whenever DCVDD drops below the minimum threshold $V_{por_dcvgd_off}$ or AVDD drops below the minimum threshold $V_{por_avdd_off}$.

SYMBOL	MIN	TYP	MAX	UNIT
V_{por_dcvgd}	0.4	0.6	0.8	V
$V_{por_dcvgd_on}$	0.9	1.26	1.6	V
$V_{por_avdd_on}$	0.5	0.7	0.9	V
$V_{por_avdd_off}$	0.4	0.6	0.8	V

Table 2 Typical POR Operation (typical values, not tested)

DEVICE DESCRIPTION

INTRODUCTION

The WM8751L is a low power audio DAC offering a combination of high quality audio, advanced features, low power and small size. These characteristics make it ideal for portable digital audio applications such as portable music players and smartphones.

The device has a configurable digital audio interface where digital audio data is fed to the internal digital filters and then the DAC. The interface supports a number of audio data formats including I²S, DSP Mode (a burst mode in which frame sync plus 2 data packed words are transmitted), Left Justified and Right Justified formats, and can operate in master or slave modes.

The on-chip digital filters perform tone control and digital volume control according to the user setting, and convert the audio data into oversampled bitstreams, which are passed to the left and right channel DACs. A multi-bit, low-order $\Sigma\Delta$ DAC architecture with dynamic element matching is used, delivering optimum performance with low power consumption.

The DAC output signal enters an analogue mixer where analogue input signals can be added to it. The WM8751L has a total of six analogue output pins, which can be configured as stereo line-outs, mono line-outs, differential mono line-outs, stereo headphone outputs or differential mono (BTL) speaker outputs.

The WM8751L master clock can be either an industry standard $256/384 f_s$ clock or a 12MHz/24MHz USB clock. Sample rates of 8kHz, 11.025kHz, 12kHz, 16kHz, 22.05kHz, 32kHz, 44.1kHz, 48kHz, 88.2kHz and 96kHz can be generated directly from the master clock, without an external PLL. The digital filters are optimised for each sample rate.

To allow full software control over all its features, the WM8751L offers a choice of 2 or 3 wire MPU control interface. It is fully compatible and an ideal partner for a wide range of industry standard microprocessors, controllers and DSPs.

The design of the WM8751L has given much attention to power consumption without compromising performance. It operates at very low voltages, and includes the ability to power off parts of the circuitry under software control, including standby and power off modes.

SIGNAL PATH

The WM8751L signal paths consists of digital filters, DACs, analogue mixers and output drivers. Each circuit block can be enabled or disabled separately using the control bits in register 26 (see "Power Management"). Thus it is possible to utilise the analogue mixing and amplification provided by the WM8751L, irrespective of whether the DACs are running or not.

The WM8751L receives digital input data on the DACDAT pin. The digital filter block processes the data to provide the following functions:

- Digital volume control
- Tone control and Bass Boost
- Digital Mono Mix
- Sigma-Delta Modulation

Two high performance, sigma-delta audio DACs convert the digital data into two analogue signals (left and right). These can then be mixed with analogue signals from the LINEINL, LINEINR and MONOIN pins, and the mix is fed to the output drivers, LOUT1/ROUT1, LOUT2/ROUT2, and MONOOUT.

- LOUT1/ROUT1: can drive 16 Ω or 32 Ω stereo headphones or stereo line output.
- LOUT2/ROUT2: can drive an 8 Ω mono speaker, stereo headphones or a stereo line-out.
- MONOOUT: line output designed to drive a 10k Ω load.
- OUT3: multi-function output, may be used for capacitor-less headphone drive, differential mono-out, line-out or 32 Ω earpiece driver.

DIGITAL VOLUME CONTROL

The WM8751L has on-chip digital attenuation from -127dB to 0dB in 0.5dB steps, allowing the user to adjust the volume of each channel separately. The level of attenuation for an eight-bit code X is given by:

$$-0.5 \times (255 - X) \text{ dB for } 1 \leq X \leq 255; \quad \text{MUTE for } X = 0$$

The LDVU and RDVU control bits control the loading of digital volume control data. When LDVU or RDVU are set to 0, the LDACVOL or RDACVOL control data is loaded into an intermediate register, but the actual gain does not change. Both left and right gain settings are updated simultaneously when either LDVU or RDVU are set to 1.

REGISTER ADDRESS	BIT	LABEL	DEFAULT	DESCRIPTION
R10 (0Ah) Left Channel Digital Volume	7:0	LDACVOL[7:0]	11111111 (0dB)	Left DAC Digital Volume Control 0000 0000 = Digital Mute 0000 0001 = -127dB 0000 0010 = -126.5dB ... 0.5dB steps up to 1111 1111 = 0dB
	8	LDVU	0	Left DAC Volume Update 0 = Store LDACVOL in intermediate latch (no gain change) 1 = Update left and right channel gains (left = LDACVOL, right = intermediate latch)
R11 (0Bh) Right Channel Digital Volume	7:0	RDACVOL[7:0]	11111111 (0dB)	Right DAC Digital Volume Control similar to LDACVOL
	8	RDVU	0	Right DAC Volume Update 0 = Store RDACVOL in intermediate latch (no gain change) 1 = Update left and right channel gains (left = intermediate latch, right = RDACVOL)

Table 3 Digital Volume Control

TONE CONTROL

The WM8751L provides separate controls for bass and treble with programmable gains and filter characteristics. This function operates on digital audio data before it is passed to the audio DACs.

Bass control can take two different forms:

- Linear bass control: bass signals are amplified or attenuated by a user programmable gain. This is independent of signal volume, and very high bass gains on loud signals may lead to signal clipping.
- Adaptive bass boost: The bass volume is amplified by a variable gain. When the bass volume is low, it is boosted more than when the bass volume is high. This method is recommended because it prevents clipping, and usually sounds more pleasant to the human ear.

Treble control applies a user programmable gain, without any adaptive boost function.

REGISTER ADDRESS	BIT	LABEL	DEFAULT	DESCRIPTION		
R12 (0Ch) Bass Control	7	BB	0	Bass Mode 0 = Linear bass control 1 = Adaptive bass boost		
	6	BC	0	Bass Filter Characteristic 0 = Low Cutoff (130 Hz at 48kHz sampling) 1 = High Cutoff (200 Hz at 48kHz sampling)		
	3:0	BASS	1111 (OFF)	Bass Intensity		
				Code	BB=0	BB=1
				0000	+9dB	15 (max)
				0001	+9dB	14
				0010	+7.5dB	13
				...	(1.5dB steps)	...
				0111	0dB	8
				...	(1.5dB steps)	...
1011-1101				-6dB	4-2	
1110	-6dB	1 (min)				
1111	Bypass (OFF)					
R13 (0Dh) Treble Control	6	TC	0	Treble Filter Characteristic 0 = High Cutoff (8kHz at 48kHz sampling) 1 = Low Cutoff (4kHz at 48kHz sampling)		
	3:0	TRBL	1111 (Disabled)	Treble Intensity 0000 or 0001 = +9dB 0010 = +7.5dB ... (1.5dB steps) 1011 to 1110 = -6dB 1111 = Disable		

Table 4 Tone Control

Note:

All cut-off frequencies change proportionally with the DAC sample rate.

DIGITAL TO ANALOGUE CONVERTER (DAC)

Treble and linear bass enhancement may produce signals that exceed full-scale. In order to avoid limiting under these conditions, it is recommended to set the DAT bit to attenuate the digital input signal by 6dB. The gain at the outputs should be increased by 6dB to compensate for the attenuation. Cut-only tone adjustment and adaptive bass boost cannot produce signals above full-scale and therefore do not require the DAT bit to be set.

After passing through the tone control filters, digital 'de-emphasis' can be applied to the audio data if necessary (e.g. when the data comes from a CD with pre-emphasis used in the recording). De-emphasis filtering is available for sample rates of 48kHz, 44.1kHz and 32kHz.

The WM8751L also has a Soft Mute function, which gradually attenuates the volume of the digital signal to zero. This function is enabled by default. To play back an audio signal, the WM8751L must first be unmuted by setting the DACMU bit to zero.

REGISTER ADDRESS	BIT	LABEL	DEFAULT	DESCRIPTION
R5 (05h) DAC Control	7	DAT	0	DAC 6dB attenuate enable 0 = disabled (0dB) 1 = -6dB enabled
	3	DACMU	1	DAC Digital Soft Mute 1 = mute 0 = no mute (signal active)
	2:1	DEEMPH	00	De-emphasis Control 11 = 48kHz sample rate 10 = 44.1kHz sample rate 01 = 32kHz sample rate 00 = No De-emphasis

Table 5 DAC Control

The digital audio data is converted to oversampled bit streams in the on-chip, true 24-bit digital interpolation filters. The bitstream data enters two multi-bit, sigma-delta DACs, which convert them to high quality analogue audio signals. The multi-bit DAC architecture reduces high frequency noise and sensitivity to clock jitter. It also uses a Dynamic Element Matching technique for high linearity and low distortion.

In normal operation, the left and right channel digital audio data are converted to analogue in two separate DACs. However, it is also possible to disable one channel, so that the same signal (left or right) appears on both analogue output channels. Additionally, there is a mono-mix mode where the two audio channels are mixed together digitally and then converted to analogue using only one DAC, while the other DAC is switched off. The mono-mix signal can be selected to appear on both analogue output channels (see Analogue Outputs).

The DAC output defaults to non-inverted. Setting DACINV will invert the DAC output phase on both left and right channels.

REGISTER ADDRESS	BIT	LABEL	DEFAULT	DESCRIPTION
R23 (17h) Additional Control (1)	5:4	DMONOMIX[1:0]	00	DAC mono mix 00: stereo 01: mono ((L+R)/2) into DACL, '0' into DACR 10: mono ((L+R)/2) into DACR, '0' into DACL 11: mono ((L+R)/2) into DACL and DACR
	1	DACINV	0	DAC phase invert 0: non-inverted 1: inverted

Table 6 DAC Mono Mix Select

LINE INPUTS AND OUTPUT MIXERS

The WM8751L provides the option to mix the DAC output signal with analogue line-in signals from the LINEINL, LINEINR and MONOIN pins. The level of the mixed-in signals can be controlled with PGAs (Programmable Gain Amplifiers).

LINEINL, LINEINR, MONOIN+ and MONOIN- are high impedance, low capacitance AC coupled analogue inputs. They are biased internally to the reference voltage VREF. Whenever these inputs are muted or the device placed into standby mode, the inputs remain biased to VREF using special anti-thump circuitry. This reduces any audible clicks that may otherwise be heard when re-activating the inputs.

The mono mixer is designed to allow a number of signal combinations to be mixed, including the possibility of mixing both the right and left channels together to produce a mono output. To prevent overloading of the mixer when full-scale DAC left and right signals are input, the mixer inputs from the DAC outputs each have a fixed gain of -6dB. The bypass path inputs to the mono mixer have variable gain as determined by R38/R39 bits [6:4].

REGISTER ADDRESS	BIT	LABEL	DEFAULT	DESCRIPTION
R34 (22h) Left Mixer (1)	8	LD2LO	0	Left DAC to Left Mixer 0 = Disable (Mute) 1 = Enable Path
	7	LI2LO	0	LINEINL Signal to Left Mixer 0 = Disable (Mute) 1 = Enable Path
	6:4	LI2LOVOL	101 (-9dB)	LINEINL Signal to Left Mixer Volume 000 = +6dB ... (3dB steps) 111 = -15dB
R35 (23h) Left Mixer (2)	8	RD2LO	0	Right DAC to Left Mixer 0 = Disable (Mute) 1 = Enable Path
	7	MI2LO	0	MONOIN Signal to Left Mixer 0 = Disable (Mute) 1 = Enable Path
	6:4	MI2LOVOL	101 (-9dB)	MONOIN Signal to Left Mixer Volume 000 = +6dB ... (3dB steps) 111 = -15dB

Table 7 Left Output Mixer Control

REGISTER ADDRESS	BIT	LABEL	DEFAULT	DESCRIPTION
R36 (24h) Right Mixer (1)	8	LD2RO	0	Left DAC to Right Mixer 0 = Disable (Mute) 1 = Enable Path
	7	MI2RO	0	MONOIN Signal to Right Mixer 0 = Disable (Mute) 1 = Enable Path
	6:4	MI2ROVOL	101 (-9dB)	MONOIN Signal to Right Mixer Volume 000 = +6dB ... (3dB steps) 111 = -15dB
R37 (25h) Right Mixer (2)	8	RD2RO	0	Right DAC to Right Mixer 0 = Disable (Mute) 1 = Enable Path
	7	RI2RO	0	LINEINR Signal to Right Mixer 0 = Disable (Mute) 1 = Enable Path
	6:4	RI2ROVOL	101 (-9dB)	LINEINR Signal to Right Mixer Volume 000 = +6dB ... (3dB steps) 111 = -15dB

Table 8 Right Output Mixer Control

REGISTER ADDRESS	BIT	LABEL	DEFAULT	DESCRIPTION
R38 (26h) Mono Mixer (1)	8	LD2MO	0	Left DAC to Mono Mixer 0 = Disable (Mute) 1 = Enable Path
	7	LI2MO	0	LINEINL Signal to Mono Mixer 0 = Disable (Mute) 1 = Enable Path
	6:4	LI2MOVOL	101 (-9dB)	LINEINL Signal to Right Mono Volume 000 = 0dB ... (3dB steps) 111 = -21dB
R39 (27h) Mono Mixer (2)	8	RD2MO	0	Right DAC to Mono Mixer 0 = Disable (Mute) 1 = Enable Path
	7	RI2MO	0	LINEINR Signal to Mono Mixer 0 = Disable (Mute) 1 = Enable Path
	6:4	RI2MOVOL	101 (-9dB)	LINEINR Signal to Mono Mixer Volume 000 = 0dB ... (3dB steps) 111 = -21dB

Table 9 Mono Output Mixer Control

Note:

The mono mixer has half the gain of the left and right mixers (i.e. 6dB less), to ensure that the left and right channels can be mixed to mono without clipping.

DIFFERENTIAL MONO LINE-IN

The WM8751L can take either a single-ended or a differential mono signal and mix it into the LOUT1/2 and ROUT1/2 outputs. In both cases, LINEINL and LINEINR still remain available as stereo line-in. Differential mono input mode is enabled by setting the DMEN bit, as shown below.

REGISTER ADDRESS	BIT	LABEL	DEFAULT	DESCRIPTION
R38 (26h) Mono Mixer (1)	0	DMEN	0	Differential mono line-in enable 0 = Single-ended line-in from MONOIN+ 1 = Differential line-in

Table 10 Differential Mono Line-in Enable

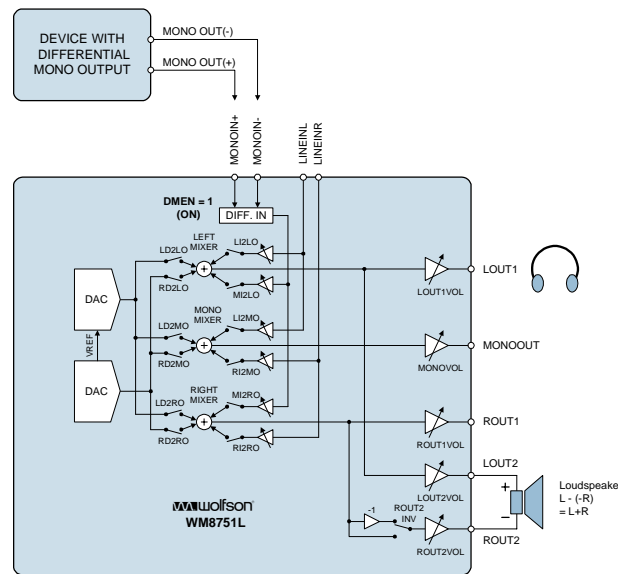

Figure 8 Differential Mono Line-in Configuration

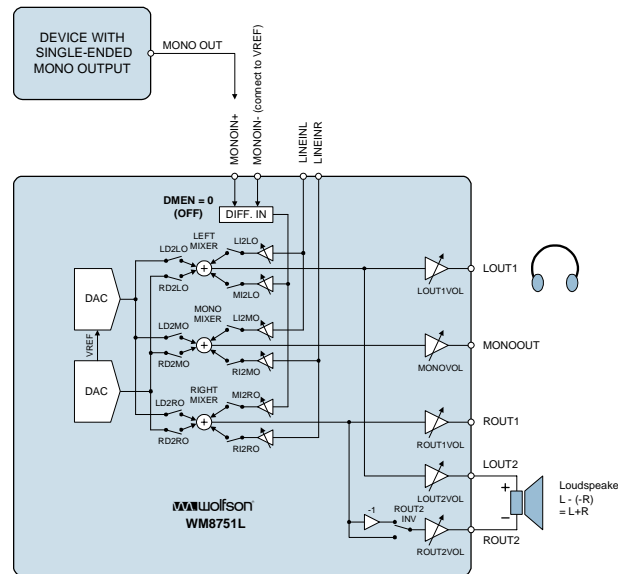

Figure 9 Single-ended Mono Line-in Configuration

ANALOGUE OUTPUTS

ENABLING THE OUTPUTS

Each analogue output of the WM8751L can be separately enabled or disabled. The analogue mixer associated with each output is powered on or off along with the output pin. All outputs are disabled by default. To save power, unused outputs should remain disabled.

Outputs can be enabled at any time, except when the WM8751L is in OFF mode, as this may cause pop noise (see Minimising Pop Noise at the Analogue Outputs)

REGISTER ADDRESS	BIT	LABEL	DEFAULT	DESCRIPTION
R26 (1Ah) Power Management (2)	6	LOUT1	0	0 = LOUT1 disabled 1 = LOUT1 enabled
	5	ROUT1	0	0 = ROUT1 disabled 1 = ROUT1 enabled
	4	LOUT2	0	0 = LOUT2 disabled 1 = LOUT2 enabled
	3	ROUT2	0	0 = ROUT2 disabled 1 = ROUT2 enabled
	2	MONO	0	0 = MONOOUT disabled 1 = MONOOUT enabled
	1	OUT3	0	0 = OUT3 disabled 1 = OUT3 enabled

Table 11 Analogue Output Control

Whenever an analogue output is disabled, it remains connected to VREF (pin 20) through a resistor. This helps to prevent pop noise when the output is re-enabled. The resistance between VREF and each output can be controlled using the VROI bit in register 27. The default is low (1.5k Ω), so that any capacitors on the outputs can charge up quickly at start-up. If a high impedance is desired for disabled outputs, VROI can then be set to 1, increasing the resistance to about 40k Ω .

REGISTER ADDRESS	BIT	LABEL	DEFAULT	DESCRIPTION
R27 (1Bh) Additional (3)	6	VROI	0	VREF to analogue output resistance 0: 1.5 k Ω 1: 40 k Ω

Table 12 Disabled Outputs to VREF Resistance

THERMAL SHUTDOWN

The speaker and headphone outputs can drive very large currents. To protect the WM8751L from overheating, a thermal shutdown circuit is included. If the device temperature reaches approximately 150 $^{\circ}$ C and the thermal shutdown circuit is enabled (TSDEN = 1) then the speaker and headphone amplifiers (outputs OUT1L/R, OUT2L/R and OUT3) will be disabled.

REGISTER ADDRESS	BIT	LABEL	DEFAULT	DESCRIPTION
R23 (17h) Additional (1)	8	TSDEN	0	Thermal Shutdown Enable 0 : thermal shutdown disabled 1 : thermal shutdown enabled

Table 13 Thermal Shutdown

HEADPHONE SWITCH

The HPDETECT pin can be used as a headphone switch control input to automatically disable the speaker output and enable the headphone output e.g. when a headphone is plugged into a jack socket. In this mode, enabled by setting HPSWEN, HPDETECT switches between headphone and speaker outputs (typically, the pin is connected to a mechanical switch in the headphone socket to detect plug-in). The HPSWPOL bit reverses the pin's polarity. HPDETECT has CMOS thresholds at 0.3 AVDD / 0.7 AVDD. Note that the LOUT1, ROUT1, LOU2 and ROUT2 bits in register 26 must also be set to enable headphone and speaker outputs (see tables below).

REGISTER ADDRESS	BIT	LABEL	DEFAULT	DESCRIPTION
R24 (18h) Additional (1)	6	HPSWEN	0	Headphone Switch Enable 0 : Headphone switch disabled 1 : Headphone switch enabled
	5	HPSWPOL	0	Headphone Switch Polarity 0 : HPDETECT high = headphone 1 : HPDETECT high = speaker
	3	HPSWZC	0	Headphone Switch Zero Cross Enable 0 : Switch immediately 1 : Switch on zero crossing only

Table 14 Headphone Switch

HPSWEN	HPSWPOL	HPDETECT (PIN23)	L/ROUT1 (reg. 26)	L/ROUT2 (reg. 26)	Headphone enabled	Speaker enabled
0	X	X	0	0	no	no
0	X	X	0	1	no	yes
0	X	X	1	0	yes	no
0	X	X	1	1	yes	yes
1	0	0	X	0	no	no
1	0	0	X	1	no	yes
1	0	1	0	X	no	no
1	0	1	1	X	yes	no
1	1	0	0	X	no	no
1	1	0	1	X	yes	no
1	1	1	X	0	no	no
1	1	1	X	1	no	yes

Table 15 Headphone Switch Operation

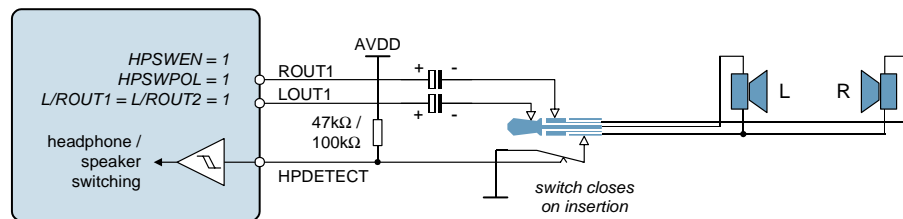

Figure 10 Example Headset Detection Circuit Using Normally-Open Switch

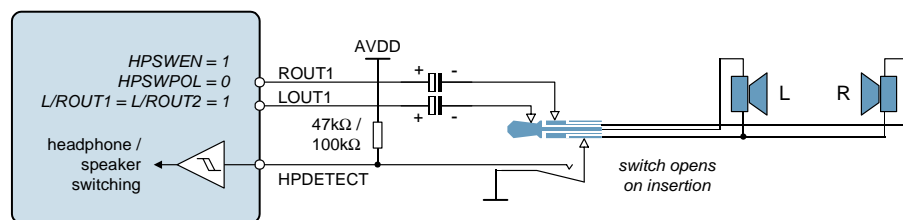

Figure 11 Example Headset Detection Circuit Using Normally-Closed Switch

LOUT1/ROUT1 OUTPUTS

The LOUT1 and ROUT1 pins can drive a 16Ω or 32Ω headphone or a line output (see Headphone Output and Line Output sections, respectively). The signal volume on LOUT1 and ROUT1 can be independently adjusted under software control by writing to LOUT1VOL and ROUT1VOL, respectively. Note that gains over 0dB may cause clipping if the signal is large. Any gain setting below 0101111 (minimum gain) mutes the output driver. The corresponding output pin remains at the same DC level (the reference voltage on the VREF pin), so that no click noise is produced when muting or un-muting.

The analogue outputs have a zero cross detect feature to minimize audible clicks and zipper noise on gain changes (i.e. the updating of the gain value is delayed until the signal passes through zero). By default, this includes a time-out function, which forces the gain to update if no zero crossing occurs within a certain period of time.

REGISTER ADDRESS	BIT	LABEL	DEFAULT	DESCRIPTION
R2 (02h) LOUT1 Volume	6:0	LOUT1VOL	1111001 (0dB)	LOUT1 Volume 1111111 = +6dB ... (80 steps) 0110000 = -67dB 0101111 to 0000000 = Analogue MUTE
	7	LO1ZC	0	LOUT1 zero cross enable 1 = Change gain on zero cross only 0 = Change gain immediately
	8	LO1VU	0	Left Volume Update 0 = Store LOUT1VOL in intermediate latch (no gain change) 1 = Update left and right channel gains (left = LOUT1VOL, right = intermediate latch)
R3 (03h) ROUT1 Volume	6:0	ROUT1VOL	1111001 (0dB)	ROUT1 Volume Similar to LOUT1VOL
	7	RO1ZC	0	ROUT1 zero cross enable Similar to LO1ZC
	8	RO1VU	0	Right Volume Update 0 = Store ROUT1VOL in intermediate latch (no gain change) 1 = Update left and right channel gains (left = intermediate latch, right = ROUT1VOL)
R23 (17h)	0	TOEN	1	Time-out enable for zero-cross detectors 0 = time-out disabled (i.e. gains are never updated if there is no zero crossing) 1 = time-out enabled

Table 16 LOUT1/ROUT1 Volume Control

LOUT2/ROUT2 OUTPUTS

The LOUT2 and ROUT2 output pins are essentially similar to LOUT1 and ROUT1, but they are independently controlled and can also drive an 8Ω mono speaker. For speaker drive, the ROUT2 signal must be inverted (ROUT2INV = 1), so that the left and right channel are mixed to mono in the speaker [L-(-R) = L+R].

REGISTER ADDRESS	BIT	LABEL	DEFAULT	DESCRIPTION
R40 (28h) LOUT2 Volume	6:0	LOUT2VOL	1111001 (0dB)	similar to LOUT1VOL
	7	LO2ZC	0	Left zero cross enable 1 = Change gain on zero cross only 0 = Change gain immediately
	8	LO2VU	0	similar to LO1VU
R41 (29h) ROUT2 Volume	6:0	ROUT2VOL	1111001 (0dB)	similar to ROUT1VOL
	7	RO2ZC	0	Left zero cross enable 1 = Change gain on zero cross only 0 = Change gain immediately
	8	RO2VU	0	similar to RO1VU
R23 (17h)	0	TOEN	1	as for LOUT1 / ROUT1
R24 (18h) Additional (2)	4	ROUT2INV	0	ROUT2 Invert 0 = No Inversion (0° phase shift) 1 = Signal inverted (180° phase shift)

Table 17 LOUT2/ROUT2 Control**MONO OUTPUT**

The MONOOUT pin can drive a mono line output. The signal volume on MONOOUT can be adjusted under software control by writing to MONOOUTVOL.

REGISTER ADDRESS	BIT	LABEL	DEFAULT	DESCRIPTION
R42 (2Ah) MONOOUT Volume	6:0	MONOOUT VOL	1111001 (0dB)	MONOOUT Volume 1111111 = +6dB ... (80 steps) 0110000 = -67dB 0101111 to 0000000 = Analogue MUTE
	7	MOZC	0	MONOOUT zero cross enable 1 = Change gain on zero cross only 0 = Change gain immediately
R23 (17h)	0	TOEN	1	as for LOUT1 / ROUT1

Table 18 MONOOUT Volume Control**OUT3 OUTPUT**

The OUT3 pin can drive a 16Ω or 32Ω headphone or a line output or be used as a DC reference for a headphone output. It can be selected to either drive out an inverted ROUT1 or inverted MONOOUT for e.g. an earpiece drive between OUT3 and LOUT1 or differential output between OUT3 and MONOOUT. OUT3 can also drive an un-inverted ROUT1 signal, which originates at the right mixer output before the output PGA.

OUT3SW selects the mode of operation required.

REGISTER ADDRESS	BIT	LABEL	DEFAULT	DESCRIPTION
R24 (18h) Additional (2)	8:7	OUT3SW	00	OUT3 select 00 : VREF 01 : ROUT1 10 : MONOOUT 11 : right mixer output

Table 19 OUT3 Select

DIGITAL AUDIO INTERFACE

The digital audio interface is used for feeding audio data into the WM8751L. It uses three pins:

- DACDAT: DAC data input
- DACLRC: DAC data alignment clock
- BCLK: Bit clock, for synchronisation

The clock signals BCLK and DACLRC can be outputs when the WM8751L operates as a master, or inputs when it is a slave (see Master and Slave Mode Operation, below).

Four different audio data formats are supported:

- Left justified
- Right justified
- I²S
- DSP mode

All four of these modes are MSB first. They are described in Audio Data Formats, below. Refer to the Electrical Characteristic section for timing information.

MASTER AND SLAVE MODE OPERATION

The WM8751L can be configured as either a master or slave mode device. As a master device the WM8751L generates BCLK and DACLRC and thus controls sequencing of the data transfer on DACDAT. In slave mode, the WM8751L responds with data to clocks it receives over the digital audio interface. The mode can be selected by writing to the MS control bit. Master and slave modes are illustrated below.

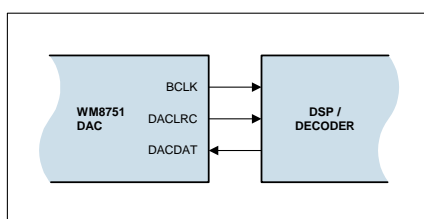

Figure 12 Master Mode

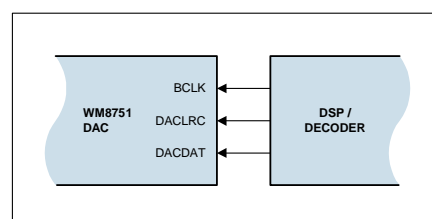

Figure 13 Slave Mode

AUDIO DATA FORMATS

In Left Justified mode, the MSB is available on the first rising edge of BCLK following a DACLRC transition. The other bits up to the LSB are then transmitted in order. Depending on word length, BCLK frequency and sample rate, there may be unused BCLK cycles before each DACLRC transition.

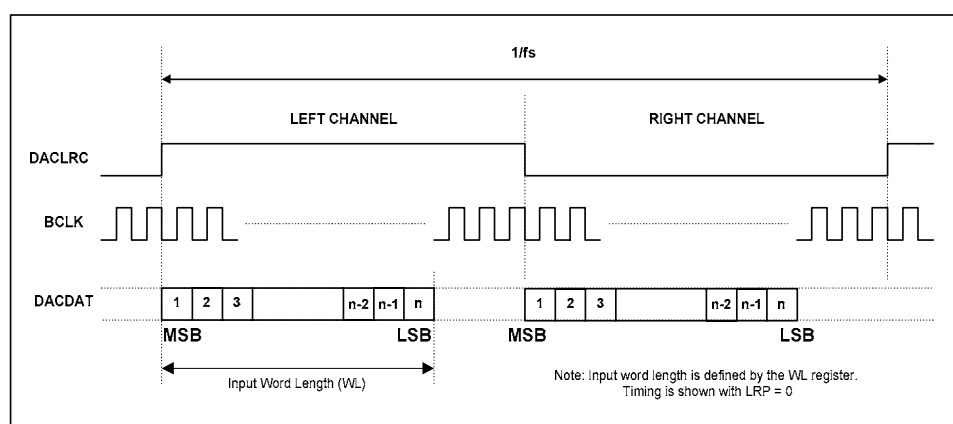

Figure 14 Left Justified Audio Interface (assuming n-bit word length)

In Right Justified mode, the LSB is available on the last rising edge of BCLK before a DACLRC transition. All other bits are transmitted before (MSB first). Depending on word length, BCLK frequency and sample rate, there may be unused BCLK cycles after each DACLRC transition.

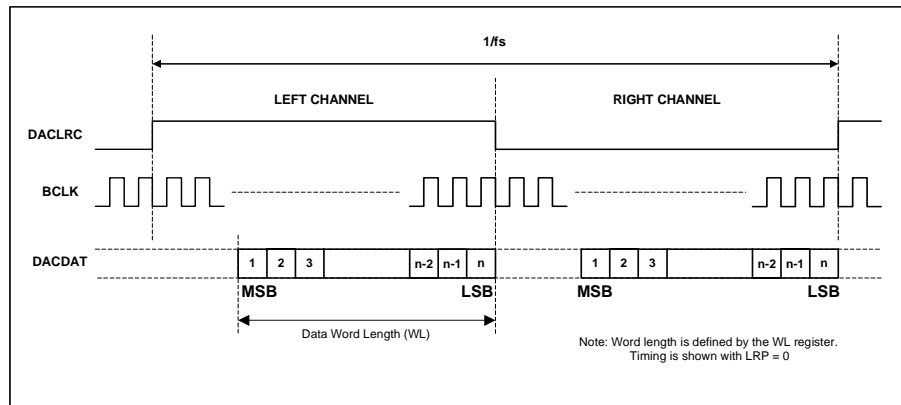

Figure 15 Right Justified Audio Interface (assuming n-bit word length)

In I²S mode, the MSB is available on the second rising edge of BCLK following a DACLRC transition. The other bits up to the LSB are then transmitted in order. Depending on word length, BCLK frequency and sample rate, there may be unused BCLK cycles between the LSB of one sample and the MSB of the next.

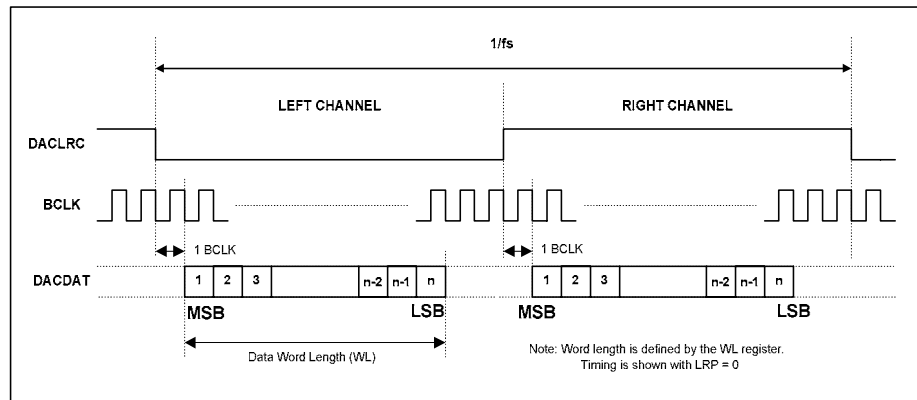

Figure 16 I2S Justified Audio Interface (assuming n-bit word length)

In DSP/PCM mode, the left channel MSB is available on either the 1st (mode B) or 2nd (mode A) rising edge of BCLK (selectable by LRP) following a rising edge of LRC. Right channel data immediately follows left channel data. Depending on word length, BCLK frequency and sample rate, there may be unused BCLK cycles between the LSB of the right channel data and the next sample.

In device master mode, the LRC output will resemble the frame pulse shown in Figure 17 and Figure 18. In device slave mode, Figure 19 and Figure 20, it is possible to use any length of frame pulse less than 1/fs, providing the falling edge of the frame pulse occurs greater than one BCLK period before the rising edge of the next frame pulse.

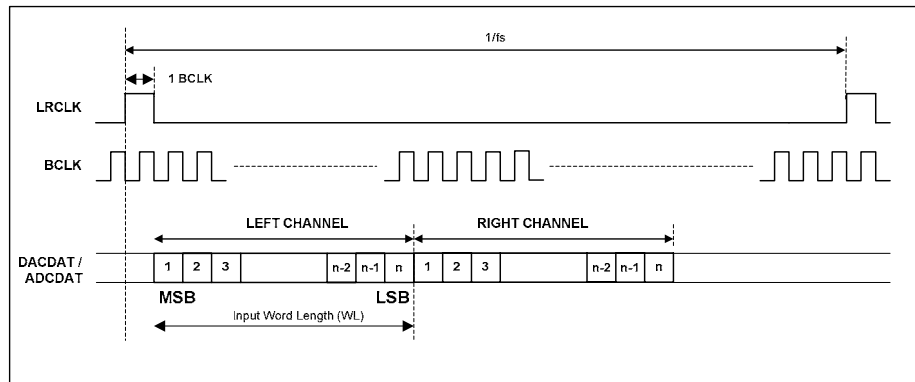

Figure 17 DSP/PCM Mode Audio Interface (mode A, LRP=0, Master)

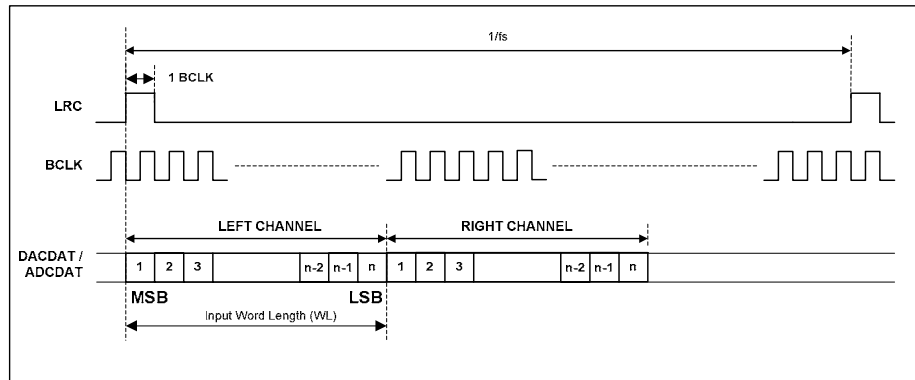

Figure 18 DSP/PCM Mode Audio Interface (mode B, LRP=1, Master)

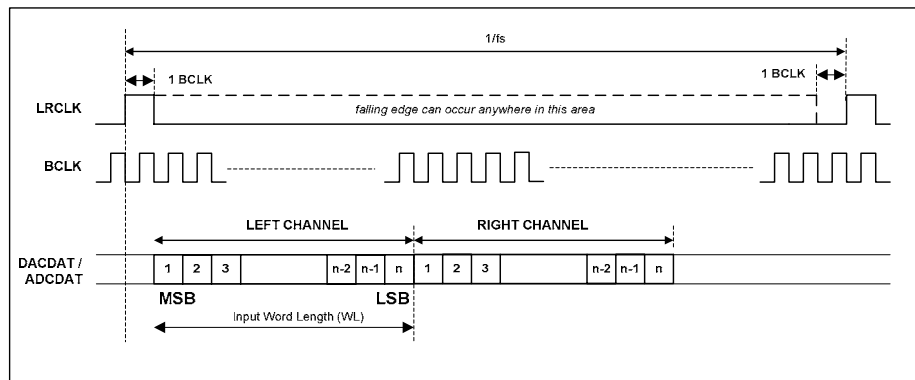

Figure 19 DSP/PCM Mode Audio Interface (mode A, LRP=0, Slave)

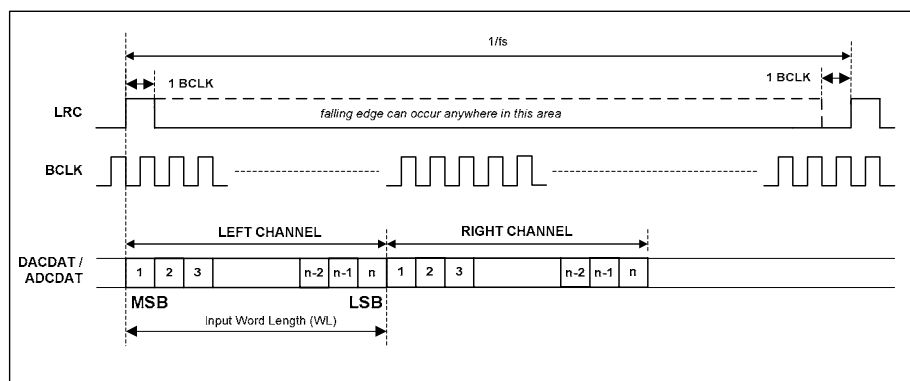

Figure 20 DSP/PCM Mode Audio Interface (mode B, LRP=0, Slave)

AUDIO INTERFACE CONTROL

The register bits controlling audio format, word length and master / slave mode are summarised below.

REGISTER ADDRESS	BIT	LABEL	DEFAULT	DESCRIPTION	
R7 (07h) Digital Audio Interface Format	1:0	FORMAT	10	Audio Data Format Select 11 = DSP Mode 10 = I ² S Format 01 = Left justified 00 = Right justified	
	3:2	WL	10	Audio Data Word Length 11 = 32 bits (see Note) 10 = 24 bits 01 = 20 bits 00 = 16 bits	
	4	LRP	0	I ² S, LJ, RJ Formats 1: Right Channel data when DACLRC high 0: Right Channel data when DACLRC low	DSP Format 1: MSB available on 2nd BCLK rising edge after LRC rising edge 0: MSB available on 1st BCLK rising edge after LRC rising edge
	5	LRSWAP	0	Swap Left and Right Channels 0: No swap (L to L, R to R) 1: Swap (L to R, R to L)	
	6	MS	0	Master / Slave Mode Control 1: Master Mode 0: Slave Mode	
	7	BCLKINV	0	BCLK Invert 1: BCLK inverted 0: BCLK not inverted	

Table 20 Audio Data Format Control

Note:

Right Justified mode does not support 32-bit data. If WL=11 in Right justified mode, the actual word length will be 24 bits.

MASTER CLOCK AND AUDIO SAMPLE RATES

The WM8751L supports a wide range of master clock frequencies on the MCLK pin, and can generate many commonly used audio sample rates directly from the master clock.

There are two clocking modes:

- 'Normal' mode supports master clocks of 128f_s, 192f_s, 256f_s, 384f_s, and their multiples
- USB mode supports 12MHz or 24MHz master clocks. This mode is intended for use in systems with a USB interface, and eliminates the need for an external PLL to generate another clock frequency for the audio DAC.

REGISTER ADDRESS	BIT	LABEL	DEFAULT	DESCRIPTION
R8 (08h) Sample Rates	0	USB	0	Clocking Mode Select 1: USB Mode 0: 'Normal' Mode
	5:1	SR [4:0]	00000	Sample Rate Control
	6	MCLK DIV2	0	MCLK Divide by 2 0: Divide disabled 1: Divide enabled
	7	BCLKDIV2	0	Divide BITCLK output by 2 (use only in USB master mode, i.e. when USB=1, MS=1) 1 = BCLK is divided by 2 (Note 1) 0 = BCLK is not divided

Table 21 Clocking and Sample Rate Control

Note:

1. With BCLKDIV2=1, the LRCLK output produces a non-50:50 duty cycle if BCLK/LRCLK is not an even integer.

The clocking of the WM8751L is controlled using the MCLKDIV2, USB, and SR control bits. Setting the MCLKDIV2 bit divides MCLK by two internally. The USB bit selects between 'Normal' and USB mode. Each combination of the SR4 to SR0 control bits selects one MCLK division ratio and hence one sample rate (see next page). The digital filter characteristics are automatically adjusted to suit the MCLK and sample rate selected (see Digital Filter Characteristics).

Since all sample rates are generated by dividing MCLK, their accuracy depends on the accuracy of MCLK. If MCLK changes, the sample rates change proportionately. Note that some sample rates (e.g. 44.1kHz in USB mode) are approximated, i.e. they differ from their target value by a very small amount. This is not audible, as the maximum deviation is only 0.27% (8.0214kHz instead of 8kHz in USB mode - for comparison, a half-tone step corresponds to a 5.9% change in pitch).

MCLK MCLKDIV2=0	MCLK MCLKDIV2=1	DAC SAMPLE RATE	USB	SR [4:0]	FILTER TYPE	BCLK (MS=1)
'Normal' Clock Mode (** indicates backward compatibility with WM8711 and WM8721)						
12.288MHz	24.576MHz	8 kHz (MCLK/1536)	0	00010 *	1	MCLK/4
		12 kHz (MCLK/1024)	0	01000	1	MCLK/4
		16 kHz (MCLK/768)	0	01010	1	MCLK/4
		24 kHz (MCLK/512)	0	11100	1	MCLK/4
		32 kHz (MCLK/384)	0	01100 *	1	MCLK/4
		48 kHz (MCLK/256)	0	00000 *	1	MCLK/4
		96 kHz (MCLK/128)	0	01110 *	3	MCLK/2
11.2896MHz	22.5792MHz	8.0182 kHz (MCLK/1408)	0	10010	1	MCLK/4
		11.025 kHz (MCLK/1024)	0	11000	1	MCLK/4
		22.05 kHz (MCLK/512)	0	11010	1	MCLK/4
		44.1 kHz (MCLK/256)	0	10000 *	1	MCLK/4
		88.2 kHz (MCLK/128)	0	11110 *	3	MCLK/2
18.432MHz	36.864MHz	8 kHz (MCLK/2304)	0	00011 *	1	MCLK/6
		12 kHz (MCLK/1536)	0	01001	1	MCLK/6
		16 kHz (MCLK/1152)	0	01011	1	MCLK/6
		24 kHz (MCLK/768)	0	11101	1	MCLK/6
		32 kHz (MCLK/576)	0	01101 *	1	MCLK/6
		48 kHz (MCLK/384)	0	00001 *	1	MCLK/6
		96 kHz (MCLK/192)	0	01111 *	3	MCLK/3
16.9344MHz	33.8688MHz	8.0182 kHz (MCLK/2112)	0	10011 *	1	MCLK/6
		11.025 kHz (MCLK/1536)	0	11001	1	MCLK/6
		22.05 kHz (MCLK/768)	0	11011	1	MCLK/6
		44.1 kHz (MCLK/384)	0	10001 *	1	MCLK/6
		88.2 kHz (MCLK/192)	0	11111 *	3	MCLK/3
USB Mode (assumes BCLKDIV2=0. ** indicates backward compatibility with WM8711 and WM8721)						
12.000MHz	24.000MHz	8 kHz (MCLK/1500)	1	00010 *	0	MCLK
		11.0259 kHz (MCLK/1088)	1	11001	1	MCLK
		12kHz (MCLK/1000)	1	01000	0	MCLK
		16kHz (MCLK/750)	1	01010	0	MCLK
		22.0588 kHz (MCLK/544)	1	11011	1	MCLK
		24kHz (MCLK/500)	1	11100	0	MCLK
		32 kHz (MCLK/375)	1	01100 *	0	MCLK
		44.118 kHz (MCLK/272)	1	10001 *	1	MCLK
		48 kHz (MCLK/250)	1	00000 *	0	MCLK
		88.235kHz (MCLK/136)	1	11111 *	3	MCLK
		96 kHz (MCLK/125)	1	01110 *	2	MCLK

Table 22 Master Clock and Sample Rates

CONTROL INTERFACE

SELECTION OF CONTROL MODE

The WM8751L is controlled by writing to registers through a serial control interface. A control word consists of 16 bits. The first 7 bits (B15 to B9) are address bits that select which control register is accessed. The remaining 9 bits (B8 to B0) are register bits, corresponding to the 9 bits in each control register. The control interface can operate as either a 3-wire or 2-wire MPU interface. The MODE pin selects the interface format.

MODE	INTERFACE FORMAT
Low	2 wire
High	3 wire

Table 23 Control Interface Mode Selection

3-WIRE SERIAL CONTROL MODE

In 3-wire mode, every rising edge of SCLK clocks in one data bit from the SDIN pin. A rising edge on CSB latches in a complete control word consisting of the last 16 bits.

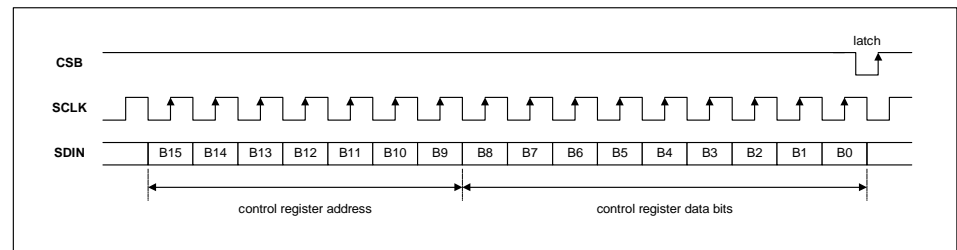

Figure 21 3-Wire Serial Control Interface

2-WIRE SERIAL CONTROL MODE

The WM8751L supports software control via a 2-wire serial bus. Many devices can be controlled by the same bus, and each device has a unique 7-bit address (this is not the same as the 7-bit address of each register in the WM8751L).

The WM8751L operates as a slave device only. The controller indicates the start of data transfer with a high to low transition on SDIN while SCLK remains high. This indicates that a device address and data will follow. All devices on the 2-wire bus respond to the start condition and shift in the next eight bits on SDIN (7-bit address + Read/Write bit, MSB first). If the device address received matches the address of the WM8751L and the R/W bit is '0', indicating a write, then the WM8751L responds by pulling SDIN low on the next clock pulse (ACK). If the address is not recognised or the R/W bit is '1', the WM8751L returns to the idle condition and wait for a new start condition and valid address.

Once the WM8751L has acknowledged a correct address, the controller sends the first byte of control data (B15 to B8, i.e. the WM8751L register address plus the first bit of register data). The WM8751L then acknowledges the first data byte by pulling SDIN low for one clock pulse. The controller then sends the second byte of control data (B7 to B0, i.e. the remaining 8 bits of register data), and the WM8751L acknowledges again by pulling SDIN low.

The transfer of data is complete when there is a low to high transition on SDIN while SCLK is high. After receiving a complete address and data sequence the WM8751L returns to the idle state and waits for another start condition. If a start or stop condition is detected out of sequence at any point during data transfer (i.e. SDIN changes while SCLK is high), the device jumps to the idle condition.

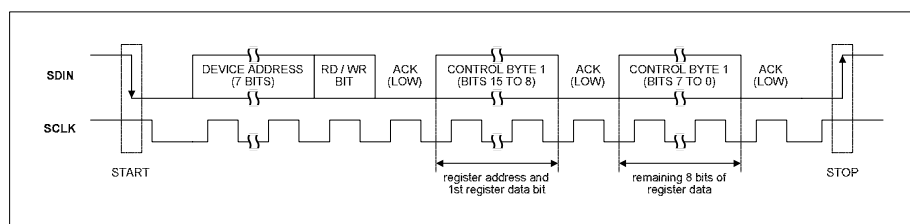

Figure 22 2-Wire Serial Control Interface

The WM8751L has two possible device addresses, which can be selected using the CSB pin.

CSB STATE	DEVICE ADDRESS
Low	0011010
High	0011011

Table 24 2-Wire MPU Interface Address Selection

POWER SUPPLIES

The WM8751L can use up to four separate power supplies:

- AVDD / AGND: Analogue supply, powers all analogue functions except the headphone drivers. AVDD can range from 1.8V to 3.6V and has the most significant impact on overall power consumption (except for power consumed in the headphone). A large AVDD slightly improves audio quality.
- HPVDD / HPGND: Headphone supply, powers the headphone drivers. HPVDD is normally tied to AVDD, but it requires separate layout and decoupling capacitors to curb harmonic distortion. If HPVDD is lower than AVDD, the output signal may be clipped.
- DCVDD: Digital core supply, powers all digital functions except the audio and control interfaces. DCVDD can range from 1.42V to 3.6V, and has no effect on audio quality. The return path for DCVDD is DGND, which is shared with DBVDD.
- DBVDD: Digital buffer supply, powers the audio and control interface buffers. This makes it possible to run the digital core at very low voltages, saving power, while interfacing to other digital devices using a higher voltage. DBVDD draws much less power than DCVDD, and has no effect on audio quality. The return path for DBVDD is DGND, which is shared with DCVDD.

It is possible to use the same supply voltage on all four. However, digital and analogue supplies should be routed and decoupled separately to keep digital switching noise out of the analogue signal paths.

POWER MANAGEMENT

The WM8751L has two control registers that allow users to select which functions are active. For minimum power consumption, unused functions should be disabled. To avoid any pop or click noise, it is important to enable or disable functions in the correct order (see Applications Information)

REGISTER ADDRESS	BIT	LABEL	DEFAULT	DESCRIPTION
R25 (19h) Power Management (1)	8:7	VMIDSEL	00	VMID resistor divider select 00 – VMID disabled 01 – 50kΩ divider enabled 10 – 500kΩ divider enabled 11 – 5kOhm divider enabled (for fast start-up)
	6	VREF	0	VREF (necessary for all other functions)
R26 (1Ah) Power Management (2)	8	DACL	0	DAC Left Enable 0=off 1=on
	7	DACR	0	DAC Right Enable 0=off 1=on
	6	LOUT1	0	LOUT1 Output Buffer* Enable 0=off 1=on
	5	ROUT1	0	ROUT1 Output Buffer* Enable 0=off 1=on
	4	LOUT2	0	LOUT2 Output Buffer* Enable 0=off 1=on
	3	ROUT2	0	ROUT2 Output Buffer* Enable 0=off 1=on
	2	MOUT	0	MONOOUT Output Buffer and Mono Mixer Enable 0=off 1=on
	1	OUT3	0	OUT3 Output Buffer Enable 0=off 1=on
Note: * The left mixer is enabled when LOUT1=1 or LOUT2=1. The right mixer is enabled when ROUT1=1 or ROUT2=1.				

Table 25 Power Management

STOPPING THE MASTER CLOCK

In order to minimise power consumed in the digital core of the WM8751L, the master clock should be stopped in Standby and OFF modes. If this is cannot be done externally at the clock source, the DIGENB bit (R25, bit 0) can be set to stop the MCLK signal from propagating into the device core. However, since setting DIGENB has no effect on the power consumption of other system components external to the WM8751L, it is preferable to disable the master clock at its source wherever possible.

REGISTER ADDRESS	BIT	LABEL	DEFAULT	DESCRIPTION
R25 (19h) Additional Control (1)	0	DIGENB	0	Master clock disable 0: master clock enabled 1: master clock disabled

Table 26 ADC and DAC Oversampling Rate Selection

NOTE: Before DIGENB can be set, the control bits DACL and DACR must be set to zero and a waiting time of 1ms must be observed. Any failure to follow this procedure may prevent DACs and ADCs from re-starting correctly.

SAVING POWER BY REDUCING OVERSAMPLING RATE

By default, the oversampling rate of the DAC digital filters is 128x. However, this can be changed to 64x by writing to the DACOSR bit. In the 64x oversampling mode, the digital filters consumes less power. However, the signal-to-noise ratio is slightly reduced.

REGISTER ADDRESS	BIT	LABEL	DEFAULT	DESCRIPTION
R24 (18h) Additional Functions (2)	0	DACOSR	0	DAC oversample rate select 1 = 64x (lowest power) 0 = 128x (best SNR)

Table 27 Oversampling Rate Selection**SAVING POWER AT LOW SUPPLY VOLTAGES**

The analogue supplies to the WM8751L can run from 1.8V to 3.6V. By default, all analogue circuitry on the device is optimized to run at 3.3V. This set-up is also good for all other supply voltages down to 1.8V. However, at lower voltages, it is possible to save power by reducing the internal bias currents used in the analogue circuitry. This is controlled as shown below.

REGISTER ADDRESS	BIT	LABEL	DEFAULT	DESCRIPTION
R23 (17h) Additional Control(1)	7:6	VSEL[1:0]	11	Analogue Bias optimization 00 : Lowest bias current, optimized for 1.8V 01 : Low bias current, optimized for 2.5V 10, 11 : Default bias current, optimized for 3.3V

Table 28 Analogue Bias Selection

REGISTER MAP

REGISTER	ADDRESS (BIT 15 – 9)	REMARKS	BIT8	BIT7	BIT6	BIT5	BIT4	BIT3	BIT2	BIT1	BIT0
R0 (00h)	0000000	Reserved	000000000								
R1 (01h)	0000001	Reserved	000000000								
R2 (02h)	0000010	LOUT1	LO1VU	LO1ZC	LOUT1VOL						
R3 (03h)	0000011	ROUT1	RO1VU	RO1ZC	ROUT1VOL						
R4 (04h)	0000100	Reserved	000000000								
R5 (05h)	0000101	DAC Control	0	DAT	0	0	0	DACMU	DEEMPH	0	
R6 (06h)	0000110	Reserved	000000000								
R7 (07h)	0000111	Audio Interface	0	BCLKINV	MS	LRSWAP	LRP	WL	FORMAT		
R8 (08h)	0001000	Clocking	0	BCLK DIV2	MCLK DIV2	SR				USB	
R9 (09h)	0001001	Reserved	000000000								
R10 (0Ah)	0001010	Left Gain	LDVU	LDACVOL (Right DAC Digital Volume)							
R11 (0Bh)	0001011	Right Gain	RDVU	RDACVOL (Right DAC Digital Volume)							
R12 (0Ch)	0001100	Bass	0	BB	BC	0	0	BASS (Bass Intensity)			
R13 (0Dh)	0001101	Treble	0	0	TC	0	0	TRBL (Treble Intensity)			
R14 (0Eh)	0001110	TBD	000000000								
R15 (0Fh)	0001111	Reset	writing 000000000 to this register resets all registers to their default state								
R16 – R22		Reserved	0000000								
R23 (17h)	0010111	Additional (1)	TSDEN	VSEL		DMONOMIX		0	0	DACINV	TOEN
R24 (18h)	0011000	Additional (2)	OUT3SW		HPSWEN	HPSWPOL	ROUT2INV	HPSWZC	0	0	DACOSR
R25 (19h)	0011001	Pwr Mgmt (1)	VMIDSEL		VREF	0	0	0	0	0	DIGENB
R26 (1Ah)	0011010	Pwr Mgmt (2)	DACL	DACR	LOUT1	ROUT1	LOUT2	ROUT2	MOUT	OUT3	0
R27 (1Bh)	0011011	Additional (3)	0	0	VROI	1	0	0	0	0	0
R28 – R33		Reserved	0000000								
R34 (22h)	0100010	Left Mix (1)	LD2LO	LI2LO	LI2LOVOL			0	0	0	0
R35 (23h)	0100011	Left Mix (2)	RD2LO	MI2LO	MI2LOVOL			0	0	0	0
R36 (24h)	0100100	Right Mix (2)	LD2RO	MI2RO	MI2ROVOL			0	0	0	0
R37 (25h)	0100101	Right Mix (1)	RD2RO	RI2RO	RI2ROVOL			0	0	0	0
R38 (26h)	0100110	Mono Mix (1)	LD2MO	LI2MO	LI2MOVOL			0	0	0	DMEN
R39 (27h)	0100111	Mono Mix (2)	RD2MO	RI2MO	RI2MOVOL			0	0	0	0
R40 (28h)	0101000	LOUT2	LO2VU	LO2ZC	LOUT2VOL						
R41 (29h)	0101001	ROUT2	RO2VU	RO2ZC	ROUT2VOL						
R42 (2Ah)	0101010	MONOOUT	0	MOZC	MOUTVOL						

DIGITAL FILTER CHARACTERISTICS

Depending on the MCLK frequency and sample rate selected, 4 different types of digital filter can be used in the DAC, called Type 0, 1, 2 and 3 (see "Master Clock and Audio Sample Rates"). The performance of Types 0 and 1 is listed in the table below, the responses of all filters is shown in the following pages.

PARAMETER	TEST CONDITIONS	MIN	TYP	MAX	UNIT
DAC Filter Type 0 (USB mode, 250fs operation)					
Passband	+/- 0.03dB	0		0.416fs	
	-6dB		0.5fs		
Passband Ripple				+/-0.03	dB
Stopband		0.584fs			
Stopband Attenuation	f > 0.584fs	-50			dB
DAC Filter Type 1 (USB mode, 272fs or Normal mode operation)					
Passband	+/- 0.03dB	0		0.4535fs	
	-6dB		0.5fs		
Passband Ripple				+/- 0.03	dB
Stopband		0.5465fs			
Stopband Attenuation	f > 0.5465fs	-50			dB

Table 29 Digital Filter Characteristics

MODE	GROUP DELAY
0 (250 USB)	11/FS
1 (256/272)	16/FS
2 (250 USB, 96k mode)	4/FS
3 (256/272, 88.2/96k mode)	3/FS

Table 30 DAC Filters

TERMINOLOGY

1. Stop Band Attenuation (dB) – the degree to which the frequency spectrum is attenuated (outside audio band)
2. Pass-band Ripple – any variation of the frequency response in the pass-band region

DAC FILTER RESPONSES

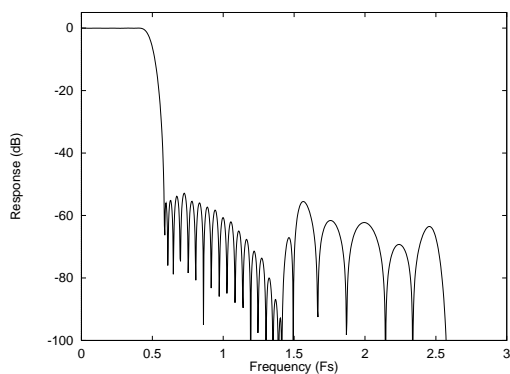

Figure 23 DAC Filter Frequency Response – Type 0

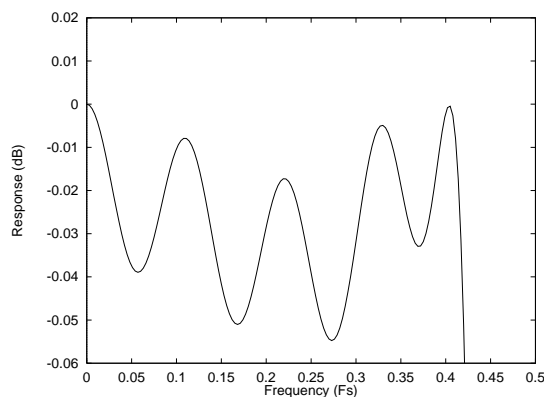

Figure 24 DAC Filter Ripple – Type 0

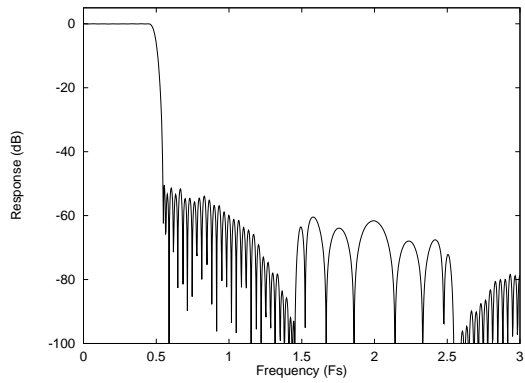

Figure 25 DAC Filter Frequency Response – Type 1

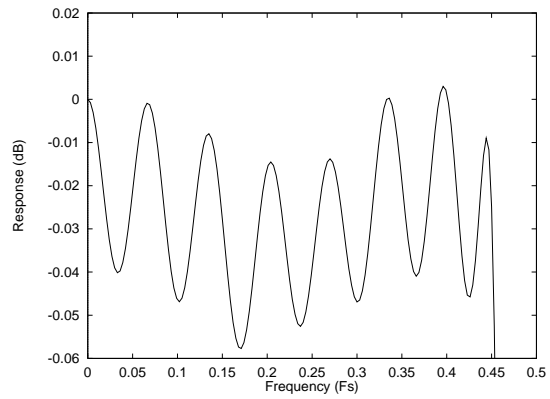

Figure 26 DAC Filter Ripple – Type 1

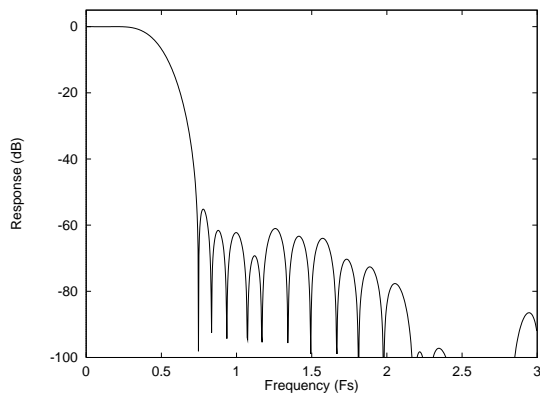

Figure 27 DAC Filter Frequency Response – Type 2

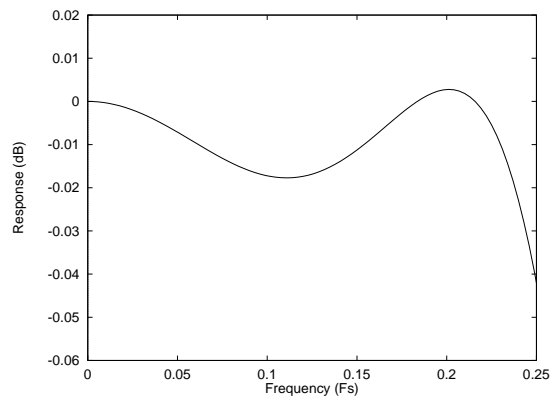

Figure 28 DAC Filter Ripple – Type 2

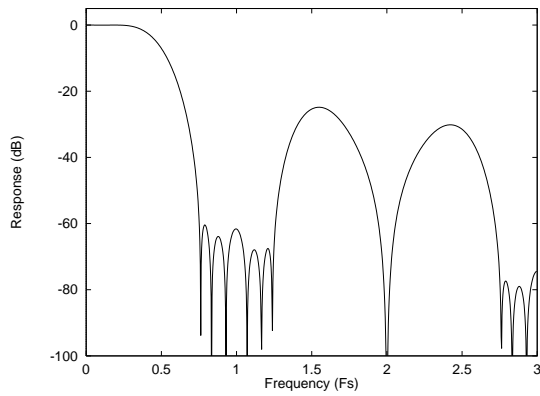

Figure 29 DAC Filter Frequency Response – Type 3

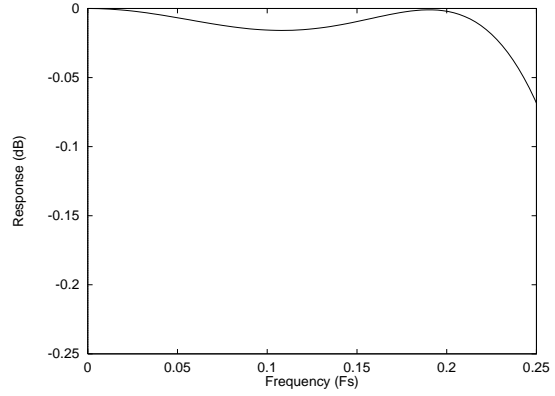

Figure 30 DAC Filter Ripple – Type 3

APPLICATIONS INFORMATION

RECOMMENDED EXTERNAL COMPONENTS

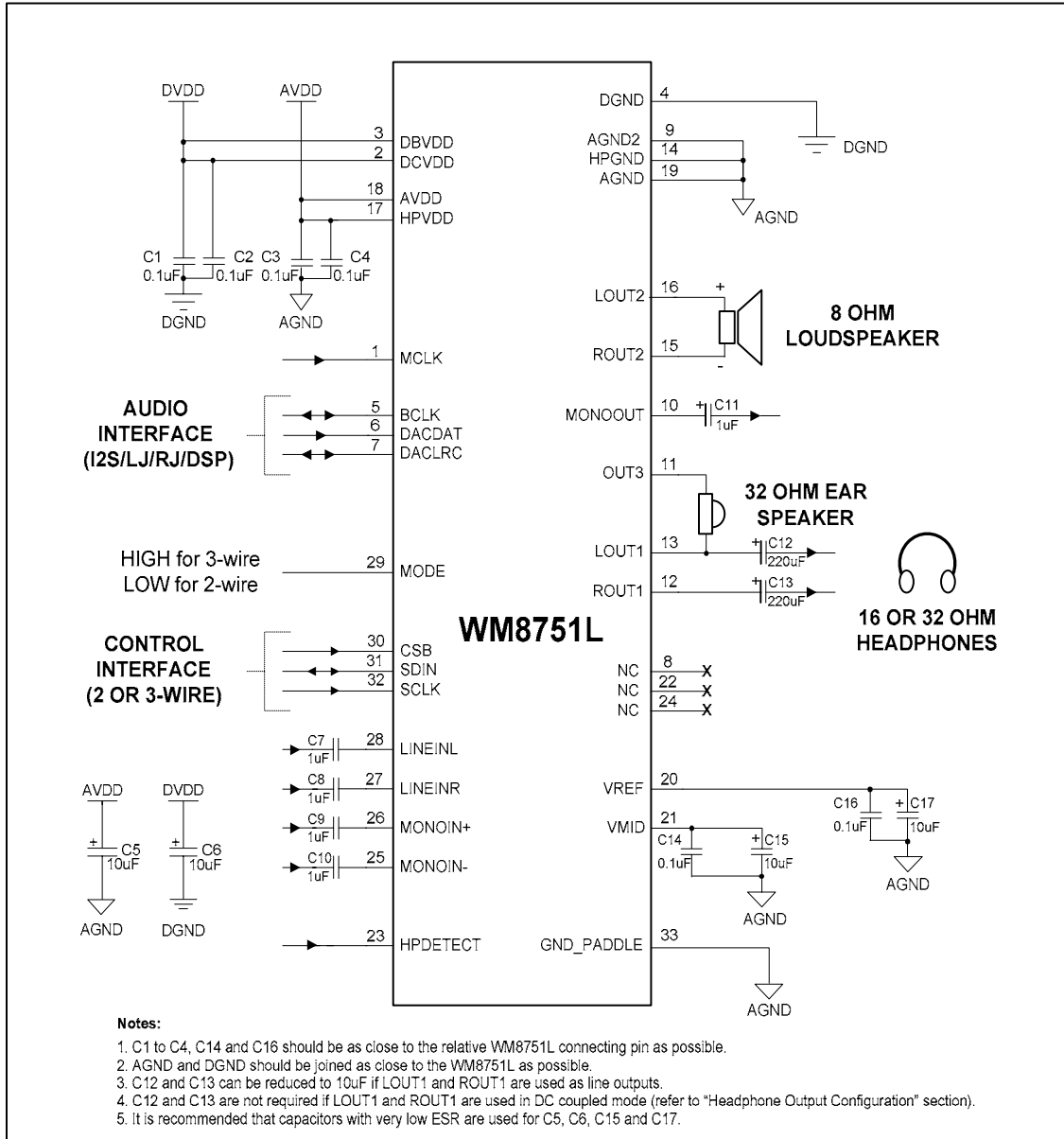

Figure 31 Recommended External Component Diagram

MINIMISING POP NOISE AT THE ANALOGUE OUTPUTS

To minimise any pop or click noise when the system is powered up or down, the following procedures are recommended.

POWER UP

- Switch on power supplies. By default the WM8751L is in OFF Mode (i.e. only the control interface is powered up)
- Enable the reference voltage VREF by setting the WM8751L to Standby mode. DO NOT enable any of the analogue outputs at this point.
- Allow VREF to settle. The settling time depends on the value of the capacitor connected at VMID, and the size of the resistors selected using VMIDSEL ($\tau = RC$).
- Enable outputs, DACs, etc. as required.
- Set DACMU = 0 to soft-un-mute the audio DACs.

POWER DOWN

- Set DACMU = 1 to soft-mute the audio DACs.
- Disable functions.
- Switch off the power supplies.

LINE OUTPUT CONFIGURATION

All the analogue outputs, LOUT1/ROUT1, LOUT2/ROUT2, and MONOOUT, can be used as line outputs. Recommended external components are shown below.

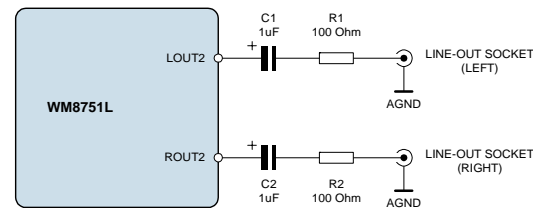

Figure 32 Recommended Circuit for Line Output

The DC blocking capacitors and the load resistance together determine the lower cut-off frequency, f_c . Assuming a 10 kOhm load and $C_1, C_2 = 10\mu\text{F}$:

$$f_c = 1 / 2\pi (R_L + R_1) C_1 = 1 / (2\pi \times 10.1\text{k}\Omega \times 1\mu\text{F}) = 16 \text{ Hz}$$

Increasing the capacitance lowers f_c , improving the bass response. Smaller values of C_1 and C_2 will diminish the bass response. The function of R_1 and R_2 is to protect the line outputs from damage when used improperly.

HEADPHONE OUTPUT CONFIGURATION

The analogue outputs LOUT1/ROUT1, LOUT2/ROUT2, and OUT3 can drive a 16Ω or 32Ω headphone load, either through DC blocking capacitors, or DC coupled without any capacitor.

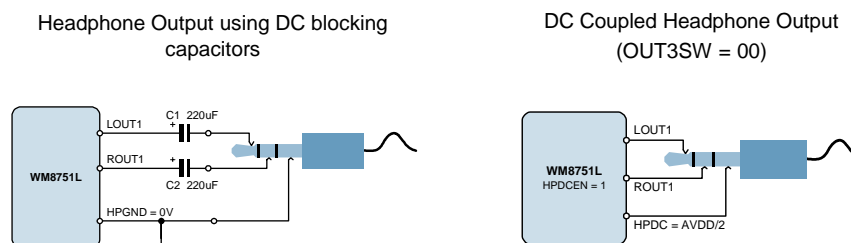

Figure 33 Recommended Headphone Output Configurations

When DC blocking capacitors are used, then their capacitance and the load resistance together determine the lower cut-off frequency, f_c . Increasing the capacitance lowers f_c , improving the bass response. Smaller capacitance values will diminish the bass response. Assuming a 16 Ohm load and $C1 = 220\mu\text{F}$:

$$f_c = 1 / 2\pi R_L C_1 = 1 / (2\pi \times 16\Omega \times 220\mu\text{F}) = 45 \text{ Hz}$$

In the DC coupled configuration, the headphone "ground" is connected to the OUT3 pin, which must be enabled by setting $\text{OUT3} = 1$ and $\text{OUT3SW} = 00$. As the OUT3 pin produces a DC voltage of $\text{AVDD}/2$ ($=V_{\text{REF}}$), there is no DC offset between LOUT1/ROUT1 and OUT3, and therefore no DC blocking capacitors are required. This saves space and material cost in portable applications.

It is recommended to connect the DC coupled headphone outputs only to headphones, and not to the line input of another device. Although the built-in short circuit protection will prevent any damage to the headphone outputs, such a connection may be noisy, and may not function properly if the other device is grounded.

SPEAKER OUTPUT CONFIGURATION

LOUT2 and ROUT2 can differentially drive a mono 8Ω speaker as shown below.

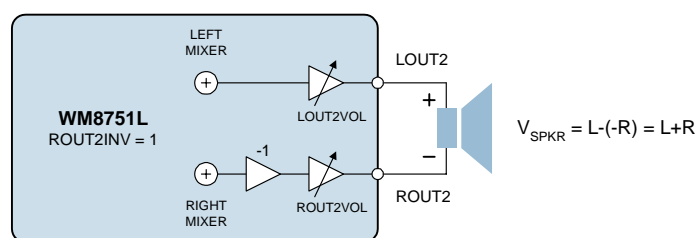
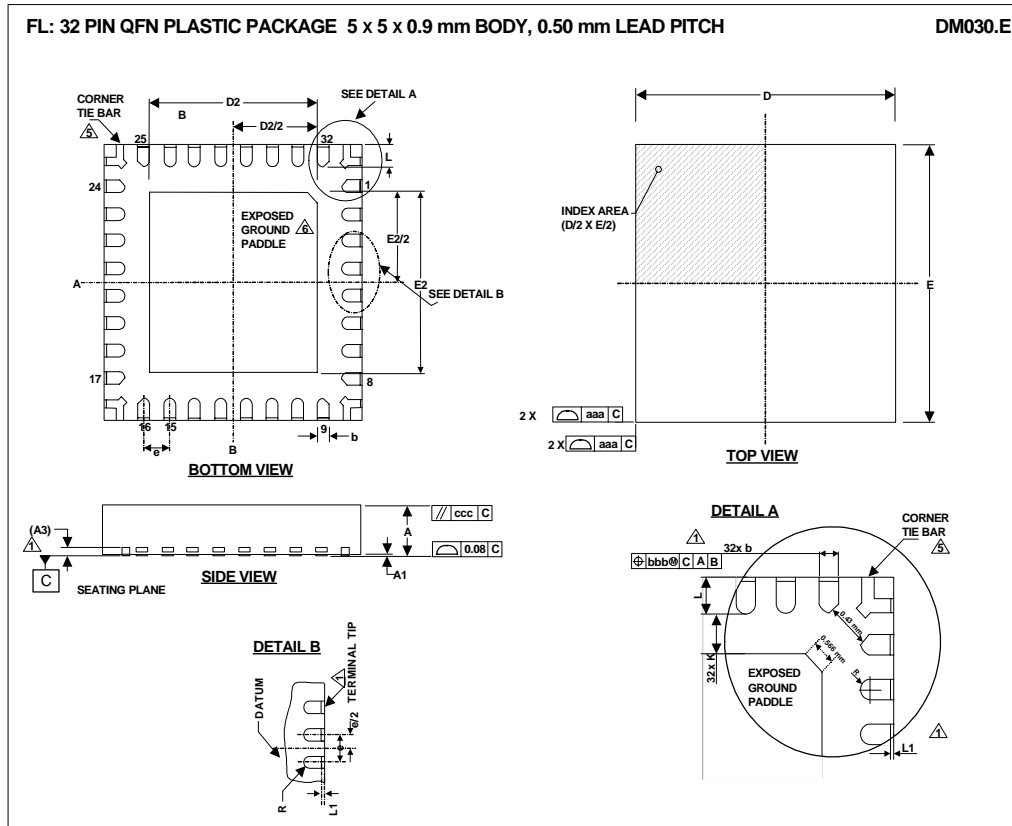

Figure 34 Speaker Output Connection

The right channel is inverted by setting the ROUT2INV bit, so that the signal across the loudspeaker is the sum of left and right channels.

PACKAGE DIMENSIONS



Symbols	Dimensions (mm)			NOTE
	MIN	NOM	MAX	
A	0.85	0.90	1.00	
A1	0	0.02	0.05	
A3		0.2 REF		
b	0.18	0.23	0.30	1
D	4.90	5.00	5.10	
D2	3.2	3.3	3.4	2
E	4.90	5.00	5.10	
E2	3.2	3.3	3.4	2
e		0.5 BSC		
L	0.35	0.4	0.45	
L1			0.1	1
R	b(min)/2			
K	0.20			
Tolerances of Form and Position				
aaa	0.15			
bbb	0.10			
ccc	0.10			
REF:	JEDEC, MO-220, VARIATION VHHD-2			

- NOTES:
- DIMENSION b APPLIED TO METALLIZED TERMINAL AND IS MEASURED BETWEEN 0.25 mm AND 0.30 mm FROM TERMINAL TIP. DIMENSION L1 REPRESENTS TERMINAL PULL BACK FROM PACKAGE SIDE WALL. MAXIMUM OF 0.1mm IS ACCEPTABLE. WHERE TERMINAL PULL BACK EXISTS, ONLY UPPER HALF OF LEAD IS VISIBLE ON PACKAGE SIDE WALL DUE TO HALF ETCHING OF LEADFRAME.
 - FALLS WITHIN JEDEC, MO-220 WITH THE EXCEPTION OF D2, E2.
 - D2, E2: LARGER PAD SIZE CHOSEN WHICH IS JUST OUTSIDE JEDEC SPECIFICATION
 - ALL DIMENSIONS ARE IN MILLIMETRES
 - THIS DRAWING IS SUBJECT TO CHANGE WITHOUT NOTICE.
 - SHAPE AND SIZE OF CORNER TIE BAR MAY VARY WITH PACKAGE TERMINAL COUNT. CORNER TIE BAR IS CONNECTED TO EXPOSED PAD INTERNALLY.
 - REFER TO APPLICATION NOTE WAN_0118 FOR FURTHER INFORMATION REGARDING PCB FOOTPRINTS AND QFN PACKAGE SOLDERING.

IMPORTANT NOTICE

Wolfson Microelectronics plc ("Wolfson") products and services are sold subject to Wolfson's terms and conditions of sale, delivery and payment supplied at the time of order acknowledgement.

Wolfson warrants performance of its products to the specifications in effect at the date of shipment. Wolfson reserves the right to make changes to its products and specifications or to discontinue any product or service without notice. Customers should therefore obtain the latest version of relevant information from Wolfson to verify that the information is current.

Testing and other quality control techniques are utilised to the extent Wolfson deems necessary to support its warranty. Specific testing of all parameters of each device is not necessarily performed unless required by law or regulation.

In order to minimise risks associated with customer applications, the customer must use adequate design and operating safeguards to minimise inherent or procedural hazards. Wolfson is not liable for applications assistance or customer product design. The customer is solely responsible for its selection and use of Wolfson products. Wolfson is not liable for such selection or use nor for use of any circuitry other than circuitry entirely embodied in a Wolfson product.

Wolfson's products are not intended for use in life support systems, appliances, nuclear systems or systems where malfunction can reasonably be expected to result in personal injury, death or severe property or environmental damage. Any use of products by the customer for such purposes is at the customer's own risk.

Wolfson does not grant any licence (express or implied) under any patent right, copyright, mask work right or other intellectual property right of Wolfson covering or relating to any combination, machine, or process in which its products or services might be or are used. Any provision or publication of any third party's products or services does not constitute Wolfson's approval, licence, warranty or endorsement thereof. Any third party trade marks contained in this document belong to the respective third party owner.

Reproduction of information from Wolfson datasheets is permissible only if reproduction is without alteration and is accompanied by all associated copyright, proprietary and other notices (including this notice) and conditions. Wolfson is not liable for any unauthorised alteration of such information or for any reliance placed thereon.

Any representations made, warranties given, and/or liabilities accepted by any person which differ from those contained in this datasheet or in Wolfson's standard terms and conditions of sale, delivery and payment are made, given and/or accepted at that person's own risk. Wolfson is not liable for any such representations, warranties or liabilities or for any reliance placed thereon by any person.

ADDRESS:

Wolfson Microelectronics plc
Westfield House
26 Westfield Road
Edinburgh
EH11 2QB
United Kingdom

Tel :: +44 (0)131 272 7000

Fax :: +44 (0)131 272 7001

Email :: sales@wolfsonmicro.com