

UTC BC327/328 PNP EPITAXIAL SILICON TRANSISTOR

SWITCHING AND AMPLIFIER APPLICATIONS

FEATURES

*Suitable for AF-Driver stages and low power output stages

*Complement to BC337/338

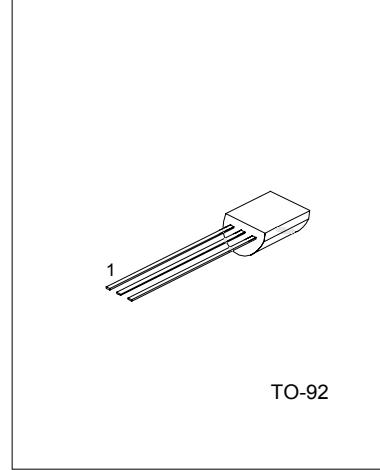

1: COLLECTOR 2: BASE 3: EMITTER

ABSOLUTE MAXIMUM RATINGS (Ta=25°C, unless otherwise specified)

PARAMETER	SYMBOL	RATING	UNIT
Collector-emitter voltage : BC327 : BC328	V _{CES}	-50 -30	V V
Collector-emitter voltage : BC327 : BC328	V _{CEO}	-45 -25	V V
Emitter-base voltage	V _{EBO}	-5	V
Collector current (DC)	I _c	-800	mA
Collector dissipation	P _c	625	mW
Junction Temperature	T _j	150	°C
Storage Temperature	T _{STG}	-55 ~ +150	°C

ELECTRICAL CHARACTERISTICS (Ta=25°C, unless otherwise specified)

PARAMETER	SYMBOL	TEST CONDITIONS	MIN	TYP	MAX	UNIT
Collector-emitter breakdown voltage : BC327 : BC328	BV _{CEO}	I _c =-10mA, I _B =0	-45 -25			V V
Collector-emitter breakdown voltage : BC327 : BC328	BV _{CES}	I _c =-0.1mA, V _{BE} =0	-50 -30			V V
Emitter-base breakdown voltage	BV _{EBO}	I _E =-10mA, I _c =0	-5			V
Collector Cut-off Current : BC327 : BC328	I _{CEs}	V _{CE} =-45V, I _B =0 V _{CE} =-25V, I _B =0		-2 -2	-100 -100	nA nA
DC current gain	h _{FE1} h _{FE2}	V _{CE} =-1V, I _c =-100mA V _{CE} =-1V, I _c =-300mA	100 40		630	
Collector-emitter saturation voltage	V _{CE(sat)}	I _c =-500mA, I _B =-50mA			-0.7	V

UTC UNISONIC TECHNOLOGIES CO., LTD. 1

UTC BC327/328 PNP EPITAXIAL SILICON TRANSISTOR

PARAMETER	SYMBOL	TEST CONDITIONS	MIN	TYP	MAX	UNIT
Base-emitter on voltage	$V_{BE(on)}$	$V_{CE}=-1V, I_c=-300mA$			-1.2	V
Current gain bandwidth product	f_T	$V_{CE}=-5V, I_c=-10mA, f=20MHz$		100		MHz
Output Capacitance	C_{ob}	$V_{CB}=-10V, I_E=0, f=1MHz$		12		pF

CLASSIFICATION OF h_{FE}

RANK	16	25	40
h_{FE1}	100-250	160-400	250-630
h_{FE2}	60~	100~	170~

UTC BC327/328 PNP EPITAXIAL SILICON TRANSISTOR

TYPICAL CHARACTERISTICS

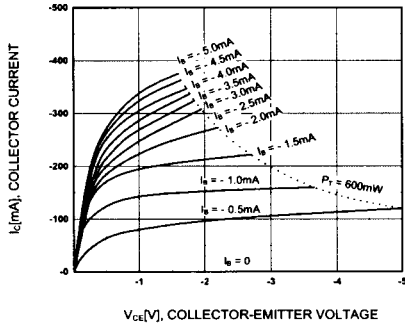

Figure 1. Static Characteristic

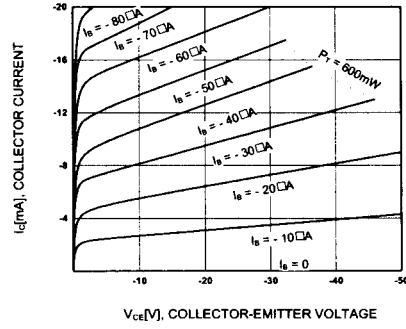

Figure 2. Static Characteristic

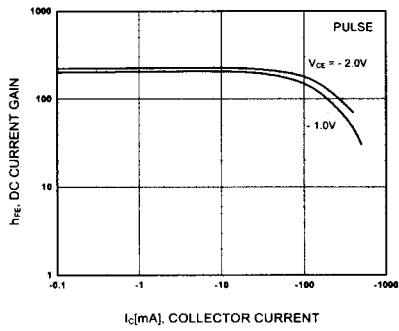

Figure 3. DC current Gain

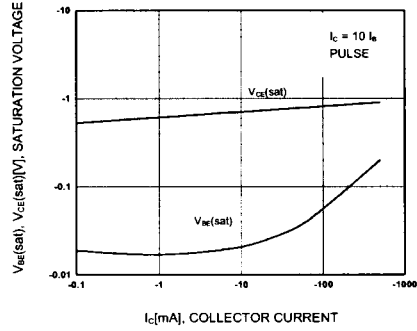

Figure 4. Base-Emitter Saturation Voltage
Collector-Emitter Saturation Voltage

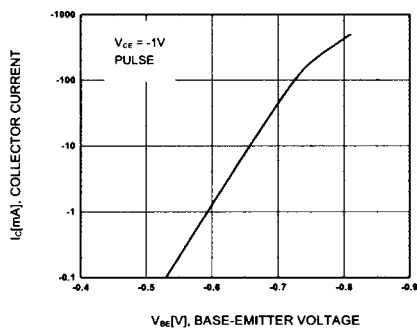

Figure 5. Base-Emitter On Voltage

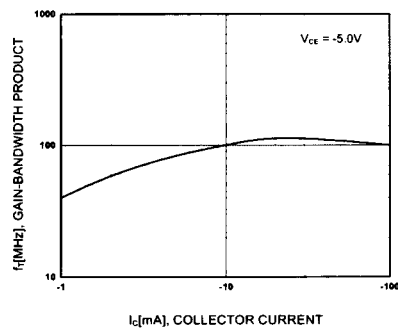

Figure 6. Gain Bandwidth Product

UTC BC327/328 PNP EPITAXIAL SILICON TRANSISTOR

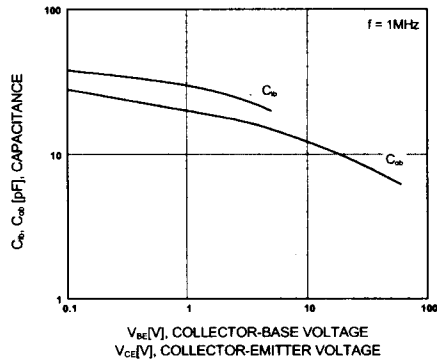

Figure 7. Input and Output Capacitance vs. Reverse Voltage

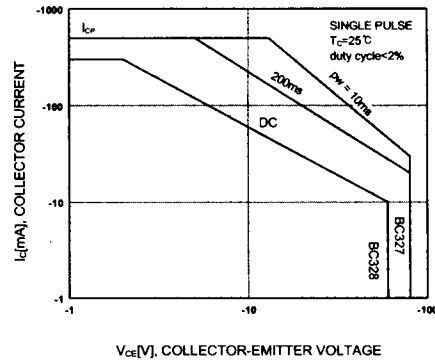

Figure 8. Safe Operating Area

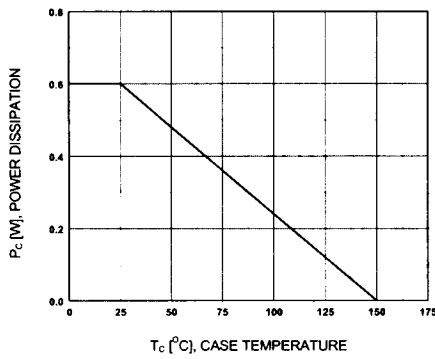

Figure 9. Power Derating

UTC assumes no responsibility for equipment failures that result from using products at values that exceed, even momentarily, rated values (such as maximum ratings, operating condition ranges, or other parameters) listed in products specifications of any and all UTC products described or contained herein. UTC products are not designed for use in life support appliances, devices or systems where malfunction of these products can be reasonably expected to result in personal injury. Reproduction in whole or in part is prohibited without the prior written consent of the copyright owner. The information presented in this document does not form part of any quotation or contract, is believed to be accurate and reliable and may be changed without notice.