



ENH084V1-300/400 COLOR TFT-LCD MODULE

GENERAL DESCRIPTION

White Electronic Designs provides optically enhanced solutions to the standard Sharp LQ084V1DG21 color active matrix LCD module. The first enhancement is an index matching (IM) film lamination to the front surface of the display polarizer. The IM film is available in two surface treatments - IM/Clear and IM/110 (a 10% diffusion). An enhanced brightness version incorporating high efficiency optical films provides and increased luminance of up to 33%.

This module is composed of a color TFT-LCD panel, driver ICs, control circuit, power supply circuit and a backlight unit. Graphics and text can be displayed on a 640 X 3 X 480 dot panel with 262,144 color by supplying 18-bit data signal (6bit/color), four timing signals, +3.3V/+5V DC supply voltage for TFT-LCD panel driving and supply voltage for backlight.

The TFT-LCD panel used for this module is a low-reflection and higher-color-saturation type. Therefore, this module is also suitable for multimedia use. Optimum viewing direction is 12 o'clock.

This module is the type of wide viewing angle and high brightness. Backlight-driving DC/AC inverter is not built in this module.

White assumes no responsibility for any damage resulting from the use of the device which does not comply with the instructions and the precautions specified in these specification sheets. White does assume the responsibility for the warranty of the enhanced product.

MECHANICAL SPECIFICATIONS

Parameter	Specifications	Units
Display size	21 (8.4") Diagonal	cm
Active area	170.9 (H) x 129.6 (V)	mm
Pixel format	640 (H) x 480 (V)	pixel
	(1 pixel=R+G+B dots)	-
Pixel pitch	0.267 (H) x 0.270 (V)	mm
Pixel configuration	R,G,B vertical stripe	-
Display mode	Normally white	-
Unit outline dimensions (1)	216.0 (W) x 152.4 (H) x 12.0(D)	mm
Mass	410 ± 20	g
Surface treatment	IM/Clear (glossy) or IM/110 and hardcoat 3H	-

Note:

1. Excluding backlight cables and mounting tabs.

Note: This measurement is typical, and see Fig. 3 for details.

White Electronic Designs Corp. reserves the right to change products or specifications without notice.

Original specifications created by Sharp.



INPUT TERMINALS
TTL-LCD Panel Driving



CN1 pin arrangement from module surface (Transparent view)
CN1 Used connector:
Corresponding connector:

DF9BA-31P-1V (Hirose Electric Co., Ltd.)
DF9-31S-1V (Hirose Electric Co., Ltd.)
DF9A-31S-1V (Hirose Electric Co., Ltd.)
DF9B-31S-1V (Hirose Electric Co., Ltd.)
DF9M-31S-1V (Hirose Electric Co., Ltd.)

Pin No.	Symbol	Function	Remarks
1	GND	-	-
2	CK	Clock signal for sampling each data signal	-
3	H _{SYNC}	Horizontal synchronous signal	(1)
4	V _{SYNC}	Vertical synchronous signal	(1)
5	GND	-	-
6	R0	RED data signal (LSB)	-
7	R1	RED data signal	-
8	R2	RED data signal	-
9	R3	RED data signal	-
10	R4	RED data signal	-
11	R5	RED data signal (MSB)	-
12	GND	-	-
13	G0	GREEN data signal (LSB)	-
14	G1	GREEN data signal	-
15	G2	GREEN data signal	-
16	G3	GREEN data signal	-
17	G4	GREEN data signal	-
18	G5	GREEN data signal (MSB)	-
19	GND	-	-
20	B0	BLUE data signal (LSB)	-
21	B1	BLUE data signal	-
22	B2	BLUE data signal	-
23	B3	BLUE data signal	-
24	B4	BLUE data signal	-
25	B5	BLUE data signal (MSB)	-
26	GND	-	-
27	ENAB	Signal to settle the horizontal display position	(2)
28	V _{CC}	+3.3/5.0V power supply	-
29	V _{CC}	+3.3/5.0V power supply	-
30	R/L	Horizontal display mode select signal	(3)
31	U/D	Vertical display mode select signal	(4)

The shielding case is not connected with GND.

Notes:

- 480 line, 400 line or 350 line mode is selected by the polarity combination of both synchronous signals.
- The horizontal display start timing is settled in accordance with a rising timing of ENAB signal. In case ENAB is fixed "Low", the horizontal start timing is determined as described in Horizontal Display Position, p.6. Don't keep ENAB "High" during operation.

Mode	480 lines	400 lines	350 lines
H _{SYNC}	negative	negative	positive
V _{SYNC}	negative	positive	negative



3.

R/L=HIGH, U/D=LOW



R/L=LOW, U/D=LOW



4.

R/L=HIGH, U/D=HIGH



R/L=LOW, U/D=HIGH



BACKLIGHT DRIVING
CNA, CNB

Used connector:
Corresponding connector:

BHR-03VS-1(JST)
SM02(8.0)B-BHS(JST)

Pin No.	Symbol	Function
1	V _{HIGH}	Power supply for lamp (High voltage side)
2	NC	This is electrically opened
3	V _{LOW}	Power supply for lamp (Low voltage side)

ABSOLUTE MAXIMUM RATINGS

Parameter	Symbol	Condition	Ratings	Unit	Remark
Input voltage	V _i	t _A =25°C	-0.3~ V _{CC} + 0.3	V	(1)
Supply voltage	V _{CC}	t _A =25°C	0~ + 6	V	-
Storage temperature	t _{STG}	-	-25~ + 70	°C	(2)
Operating temperature (Panel)	T _{OPa}	-	0~ + 63		
Operating temperature (Ambient)	T _{OPp}	-	0~ + 60	°C	

Notes:

- CK, RO~R5, G0~G5, B0~B5, H_{SYNC}, V_{SYNC}, ENAB, R/L, U/L
- Humidity: 95%RH Max. at t_A ≤ 40°C
Maximum wet-bulb temperature at 39°C or less at t_A ≤ 40°C
No condensation.



ELECTRICAL CHARACTERISTICS

$t_a=25^{\circ}\text{C}$
TFT-LCD PANEL DRIVING

Parameter	Symbol	MIN	TYP	MAX	Unit	Remarks
3.3V Supply voltage	V_{CC}	+3.0	+3.3	+3.6	V	(1)
5.0V Supply voltage	V_{CC}	+4.5	+5.0	+5.5	V	
Current dissipation	I_{CC}	-	410	460	mA	(2)
Permissive input ripple voltage	V_{RF}	-	-	100	mVp-p	$V_{CC}=+3.3\text{V}$
Input voltage (Low)	V_{IL}	-	-	$0.3V_{CC}$	V	(3)
Input voltage (High)	V_{IH}	$0.7V_{CC}$	-	-	V	
Input current (Low)	I_{OL1}	-	-	1.0	μA	$V_i=0\text{V}$ (4)
	I_{OL2}	-	-	60.0	μA	$V_i=0\text{V}$ (5)
Input current (High)	I_{OH1}	-	-	1.0	μA	$V_i=V_{CC}$ (6)
	I_{OH2}	-	-	60.0	μA	$V_i=V_{CC}$ (7)

Notes:

- V_{CC} -turn-on conditions
 $0 < t_1 \leq 15\text{ms}$
 $0 < t_2 \leq 20\text{ms}$
 $0 < t_3 \leq 1\text{s}$
 $1\text{s} < t_4$

V_{CC} -dip conditions

- $2.7\text{V} \leq V_{CC} < 3.0\text{V}$
 $t_d \leq 10\text{ms}$
- $V_{CC} \leq 2.7\text{V}$

V_{CC} -dip conditions should also follow the V_{CC} -turn-on conditions

- Typical current situation: 16-gray-bar pattern
480 line mode
 $V_{CC}=+3.3\text{V}$
- CK,R0~R5,G0~G5,B0~B5,Hsync,Vsync,ENAB,R/L,U/D
- CK,R0~R5,G0~G5,B0~B5,Hsync,Vsync,ENAB
- R/L
- CK,R0~R5,G0~G5,B0~B5,Hsync,Vsync
- ENAB,U/D

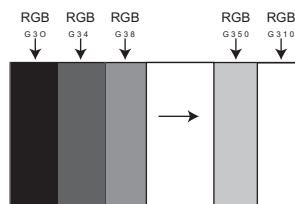
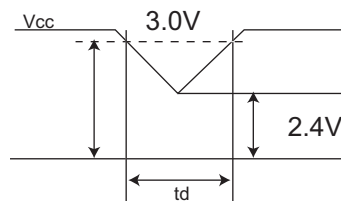
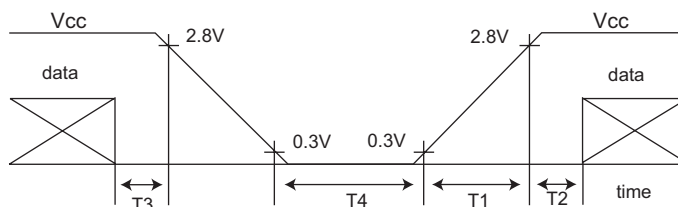



BACKLIGHT DRIVING SECTION

The backlight system is an edge-lighting type with single CCFT (Cold Cathode Fluorescent Tube).

The characteristics of a single lamp are shown in the following table..

Parameter	Symbol	MIN	TYP	MAX	Unit	Remark
Lamp current	I_L	2.0	6.0	6.5	mArms	(1)
Lamp power consumption	P_L	-	2.16	-	W	(2)
Lamp frequency	F_L	20	35	60	KHz	(3)
Kickoff voltage	V_s	-	-	800	Vrms	$t_A=25^\circ\text{C}$
		-	-	1000	Vrms	$t_A=0^\circ\text{C}$ (4)
Lamp life time	L_L	-	25000	-	hour	(5)

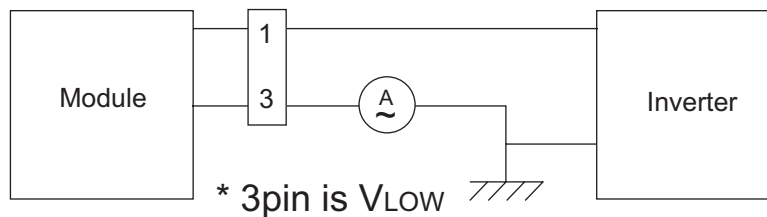

Notes:

- Lamp current is measured with current meter for high frequency as shown above.
- At the condition of $Y_L = (300 \text{ cd/m}^2)$
- Lamp frequency may produce interference with horizontal synchronous frequency, and this may cause horizontal beat on the display. Therefore, lamp frequency shall be detached as much as possible from the horizontal synchronous frequency and from the harmonics of horizontal synchronous to avoid interference.
- The open output voltage of the inverter shall be maintained for more than 1 sec; otherwise the lamp may not be turned on.
- Since lamp is consumables, the life time written above is referential value and it is not guaranteed in this specification sheet by White Electronic Designs. Lamp life time is defined that it applied either (1) or (2) under this condition (Continuous turning on at $t_A=25^\circ\text{C}$, $I_L=6\text{mArms}$)
 - Brightness becomes 50% of the original value under standard condition.
 - Kick-off voltage at $t_A=0^\circ\text{C}$ exceeds maximum value, 1500 Vrms. In case of operating under lower temp environment, the lamp exhaustion is accelerated and the brightness becomes lower.
(Continuous operating for around 1 month under lower temp condition may reduce the brightness to 50%.)
In case of such usage under lower temp environment, periodical lamp exchange by White is recommended

Note:

- The performance of the backlight, for example life time; or brightness, is extremely influenced by the characteristics of the DC-AC inverter for the lamp. When designing or ordering the inverter, make sure that poor lighting caused by the mismatch of the backlight and the inverter (mis-lighting, flicker, etc.) do not occur. Once this is confirmed, the module should be operated in the same condition as it is installed in the instrument. Recommended inverter is "CXA-L0612A-VJL(TDK corporation)".



TIMING CHARACTERISTICS OF INPUT SIGNALS

Parameter Clock		Symbol	Mode	Min.	Typ.	Max.	Unit
Clock	Frequency	1/Tc	all	-	25.18	28.33	MHz
	High Time	Tch	all	5	-	-	ns
	Low Time	Tcl	all	10	-	-	ns
Data	Set up time	Tds	all	5	-	-	ns
	Hold time	Tdh	all	10	-	-	ns
Horizontal sync. signal	Cycle	TH	all	30.00	31.78	-	µs
			all	750	800	900	clock
	Pulse width	THp	all	2	96	200	clock
Vertical sync. signal	Cycle	TV	480	515	525	560	line
			400	446	449	480	line
			350	447	449	510	line
	Pulse width	TVp	all	1	-	34	line
Horizontal display period		THd	all	640	640	640	clock
Hsync-Clock phase difference		THc	all	10	-	Tc-10	ns
Hsync.-Vsync. phase difference		TVh	all	0	-	TH-THp	clock

Notes:

- In case of lower frequency, deterioration of the display quality, flicker, etc. may occur.

HORIZONTAL DISPLAY POSITION

The horizontal display position is determined by ENAB signal and the input data corresponding to the rising edge ENAB signal is displayed at the left end of the active area.

Parameter		Symbol	MIN	TYP	MAX	Unit	Remark
Enable signal	Set-up time	Tes	5	-	Tc-10	ns	-
	Pulse width	Tep	2	640	640	clock	-
Hsync-enable signal phase difference		THE	44	-	TH-664	clock	-

Note:

- When ENAB is fixed at "Low", the display starts from the data of C104 (clock) as shown above. Be careful the module does not work when ENAB is fixed "High".



VERTICAL DISPLAY POSITION

The vertical display position is automatically centered in the active area at each mode of VGA,480-,400-,and 350-line mode. Each mode is selected depending on the polarity of the synchronous signals described in on page 2 Input Terminals, Note 1.

In each mode, the data of TVn is displayed at the top line of the active area. The display position will be centered

on the screen like the following figure when the period of vertical synchronous signal, TV, is typical value.

In 400-,and 350-line mode, the data in the vertical data invalid period is also displayed. So, inputting all data “()” is recommended during vertical data invalid period.

ENAB signal has no relation to the vertical display position.

Mode	V-data start (TVs)	V-data Perioc (TVd)	V-display Start (TVn)	V-display Period	Unit
480	34	480	34	480	line
400	34	400	443-TV	480	line
350	61	350	445-TV	480	lute

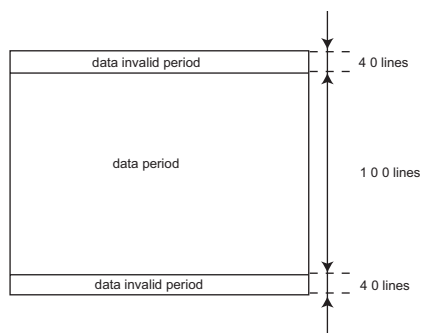

400 lines mode (TV=449)

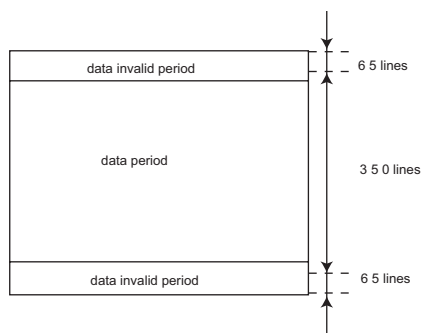

350 lines mode (TV=449)

INPUT DATA SIGNALS AND DISPLAY POSITION ON THE SCREEN

Display position of input data (480 lines mode)

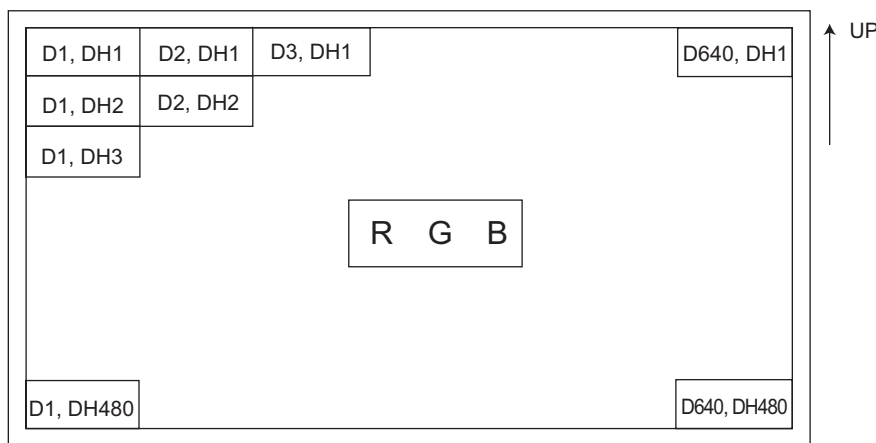

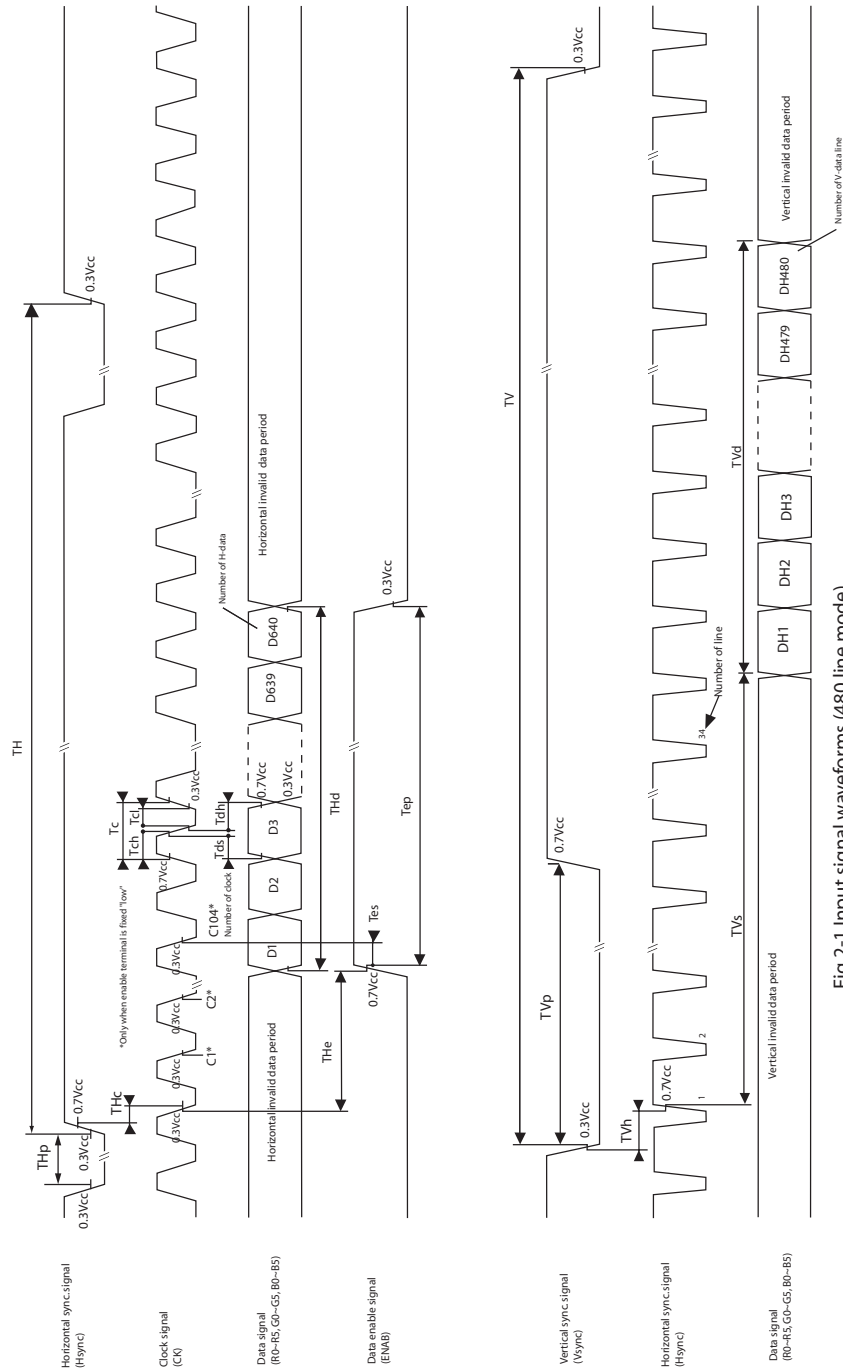

Fig 2-1 Input signal waveforms (480 line mode)

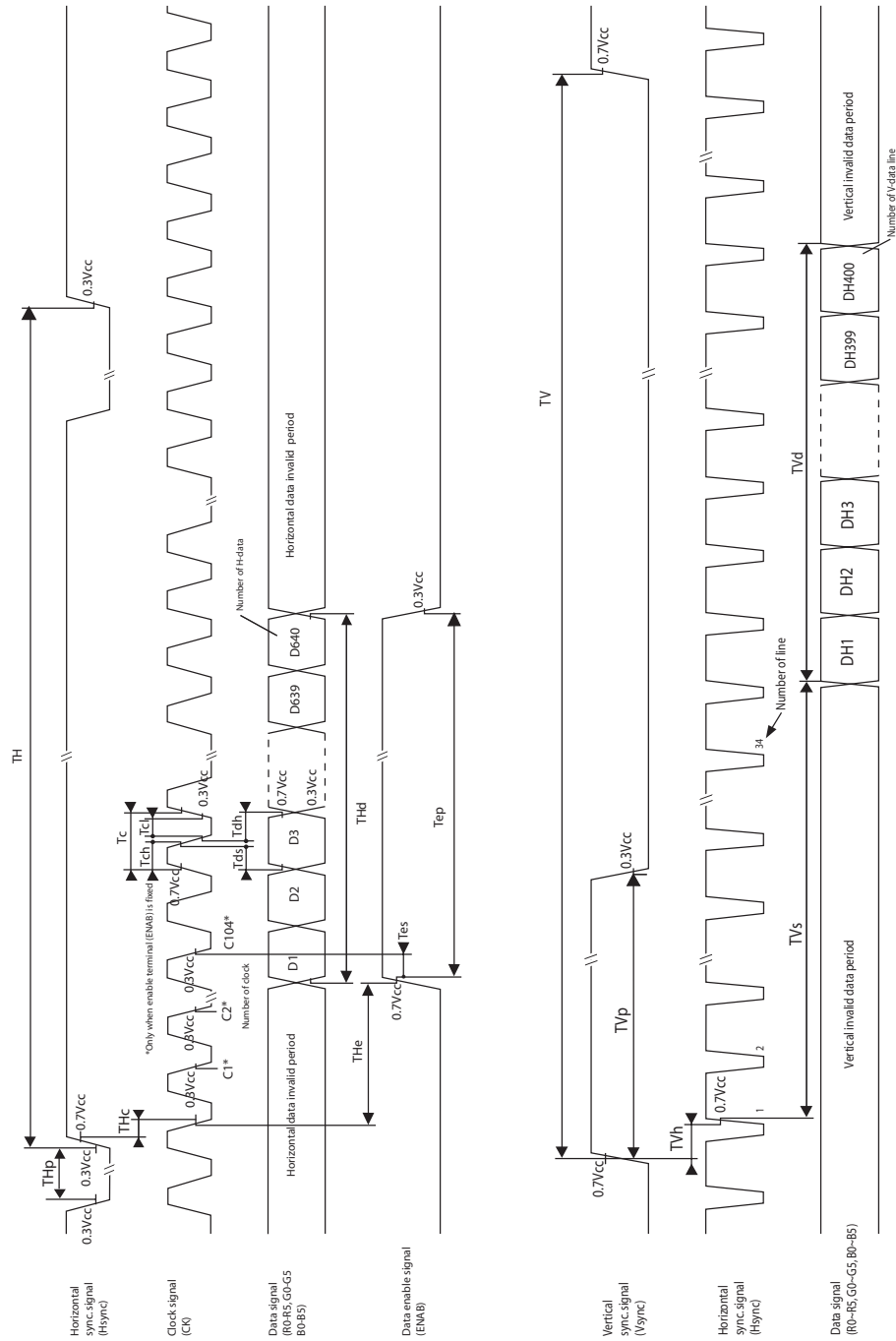

Fig 2-2 Input signal waveforms (400 line mode)

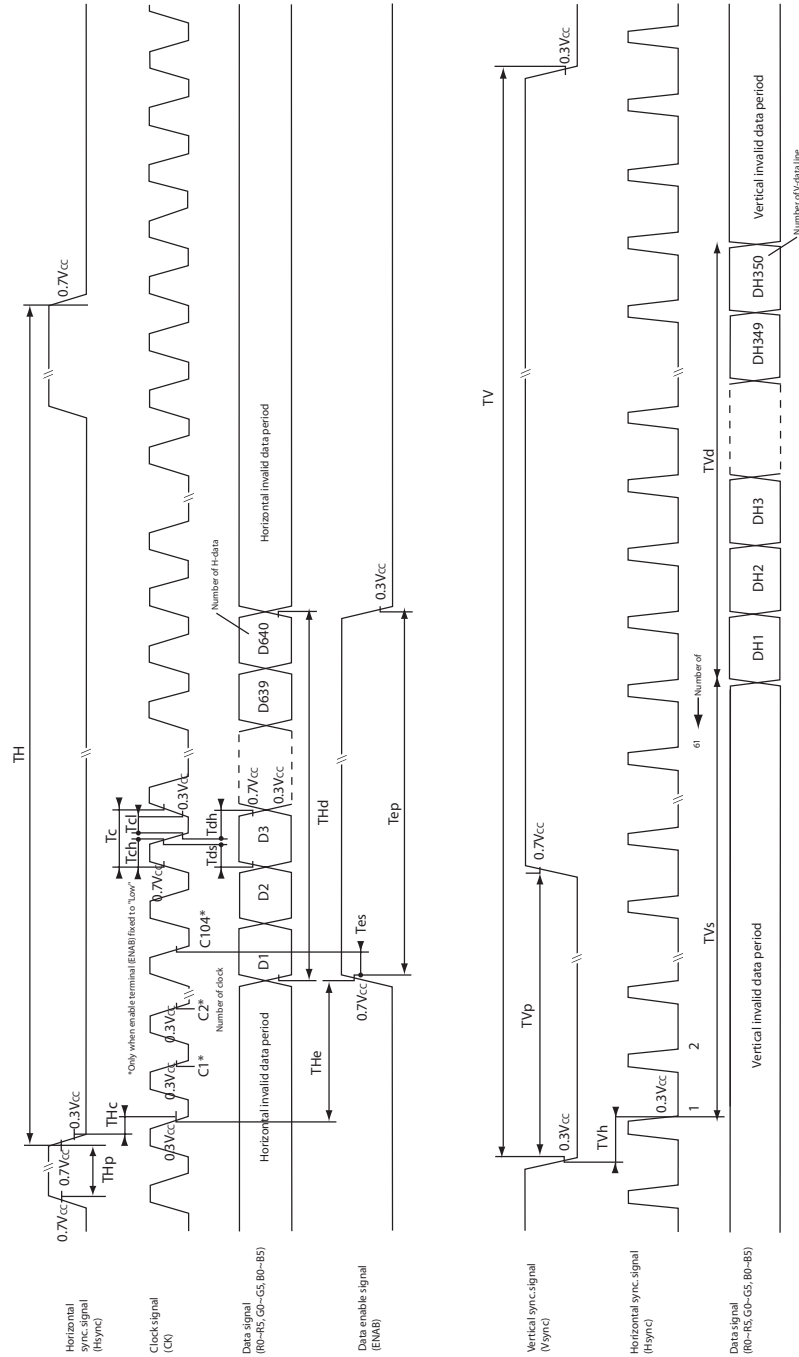

Fig. 2-3 Input signal waveforms (350 line mode)



INPUT SIGNALS, BASIC DISPLAY COLORS AND GRAY SCALE OF EACH COLOR

	Colors & Grayscale	Data signal																		
		Gray Scale	R0	R1	R2	R3	R4	R5	G0	G1	G2	G3	G4	G5	B0	B1	B2	B3	B4	B5
Basic Color	Black	-	0	0	0	0	0	0	0	0	0	0	0	0	0	0	0	0	0	0
	Blue	-	0	0	0	0	0	0	0	0	0	0	0	0	1	1	1	1	1	1
	Green	-	0	0	0	0	0	0	1	1	1	1	1	1	0	0	0	0	0	0
	Cyan	-	0	0	0	0	0	0	1	1	1	1	1	1	1	1	1	1	1	1
	Red	-	1	1	1	1	1	1	0	0	0	0	0	0	0	0	0	0	0	0
	Magenta	-	1	1	1	1	1	1	0	0	0	0	0	0	1	1	1	1	1	1
	Yellow	-	1	1	1	1	1	1	1	1	1	1	1	1	0	0	0	0	0	0
	White	-	1	1	1	1	1	1	1	1	1	1	1	1	1	1	1	1	1	1
Gray Scale of Red	Black	GS0	0	0	0	0	0	0	0	0	0	0	0	0	0	0	0	0	0	0
	↑ Darker	GS1	1	0	0	0	0	0	0	0	0	0	0	0	0	0	0	0	0	0
		GS2	0	1	0	0	0	0	0	0	0	0	0	0	0	0	0	0	0	0
		↓				↓					↓					↓				
	↓ Brighter	GS61	1	0	1	1	1	1	0	0	0	0	0	0	0	0	0	0	0	0
		GS62	0	1	1	1	1	1	0	0	0	0	0	0	0	0	0	0	0	0
		GS63	1	1	1	1	1	1	0	0	0	0	0	0	0	0	0	0	0	0
Red	GS63	1	1	1	1	1	1	0	0	0	0	0	0	0	0	0	0	0	0	
Gray Scale of Green	Black	GS0	0	0	0	0	0	0	0	0	0	0	0	0	0	0	0	0	0	0
	↑ Darker	GS1	0	0	0	0	0	0	1	0	0	0	0	0	0	0	0	0	0	0
		GS2	0	0	0	0	0	0	0	1	0	0	0	0	0	0	0	0	0	0
		↓				↓					↓					↓				
	↓ Brighter	GS61	0	0	0	0	0	0	1	0	1	1	1	1	0	0	0	0	0	0
		GS62	0	0	0	0	0	0	0	1	1	1	1	1	0	0	0	0	0	0
		GS63	0	0	0	0	0	0	1	1	1	1	1	1	0	0	0	0	0	0
Green	GS63	0	0	0	0	0	0	1	1	1	1	1	1	0	0	0	0	0	0	
Gray Scale of Blue	Black	GS0	0	0	0	0	0	0	0	0	0	0	0	0	0	0	0	0	0	0
	↑ Darker	GS1	0	0	0	0	0	0	0	0	0	0	0	0	1	0	0	0	0	0
		GS2	0	0	0	0	0	0	0	0	0	0	0	0	0	1	0	0	0	0
		↓				↓					↓					↓				
	↓ Brighter	GS61	0	0	0	0	0	0	0	0	0	0	0	0	1	0	1	1	1	1
		GS62	0	0	0	0	0	0	0	0	0	0	0	0	0	1	1	1	1	1
		GS63	0	0	0	0	0	0	0	0	0	0	0	0	1	1	1	1	1	1
Blue	GS63	0	0	0	0	0	0	0	0	0	0	0	0	1	1	1	1	1	1	

Notes:

- 0: Low level voltage 1: High level voltage.
- Each basic color can be displayed in 64 gray scales from 6 bit data signals. According to the combination of total 18 bit data signals, the 262, 144-color display can be achieved on the screen.



OPTICAL CHARACTERISTICS

$t_a=25^{\circ}\text{C}$, $V_{CC}=+5\text{V}$

Parameter	Symbol	Condition	Min	Typ	Max	Unit	Remarks	
Viewing Angle Range	Horizontal	$\theta 21, \theta 22, \theta 11$	$(CR \geq 10)$	45	55	-	Deg.	(4)
	Vertical	$\theta 12$		30	40	-	Deg.	
Contrast Ratio	CR	$\theta=0^{\circ}$	-	250	-	-	(2, 4)	
Response Time	Rise	τ_r	-	20	-	ms	(3, 4)	
	Decay	τ_d	-	40	-	ms		
Luminance of White	IM Film	γ_L	240	300	-	cd/m^2	(4)	
	Enhanced Film Stack		300	400	-			
Chromaticity of White	x	-	0.319	-	-	-	(4)	
	y	-	0.329	-	-	-		
White Uniformity	δ_w	-	-	-	1.45	-	(5)	
Viewing Angle Range as a Brightness Definition	Horizontal	$\theta 21, \theta 22$	50% of the maximum brightness	-	45	-	Deg.	(1)
	Vertical	$\theta 11$		-	30	-	Deg.	
		$\theta 12$		-	35	-	Deg.	

The measurements shall be executed 30 minutes after lighting at rating. (typical condition: $I_L=6\text{mArms}$)

The optical characteristics shall be measured in a dark room or equivalent state with the method shown in Fig. 3 below.

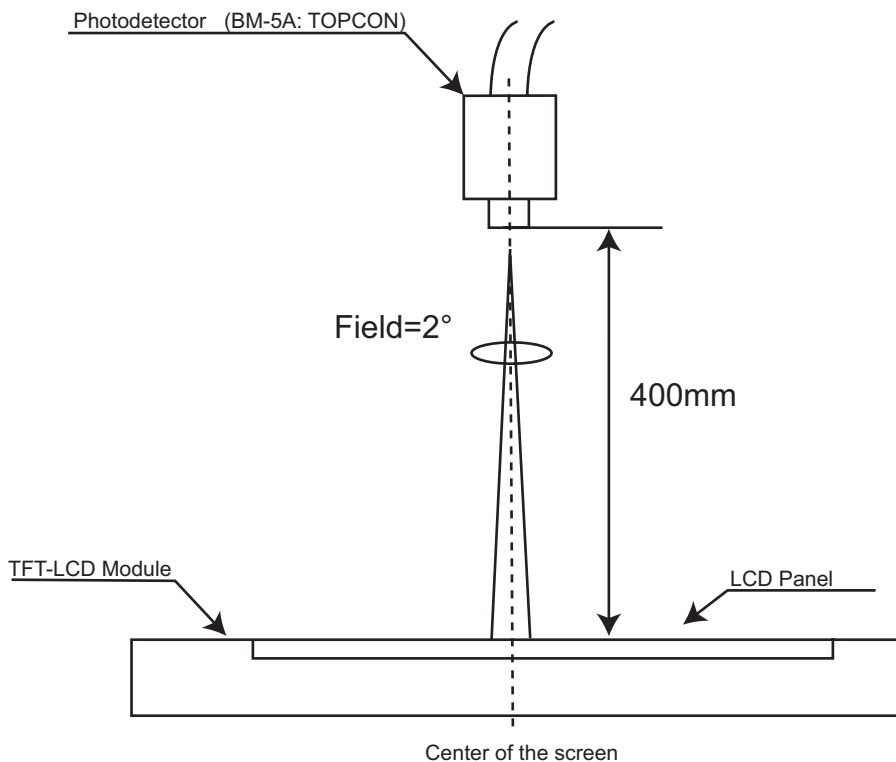



Notes:

1. Definition of viewing angle range:
2. Definition of contrast ratio
The contrast ratio is defined as follows:

$$\text{Contrast Ratio (CR)} = \frac{\text{Luminance (brightness) with all pixels white}}{\text{Luminance (brightness) with all pixels black}}$$

3. Definition of response time
The response time is defined as the following figure and shall be measured by switching the input signal for "black" and "white".
4. This shall be measured at the center of the screen.
5. Definition of white uniformity:
White uniformity is defined as the following with five measurements. (A-E).

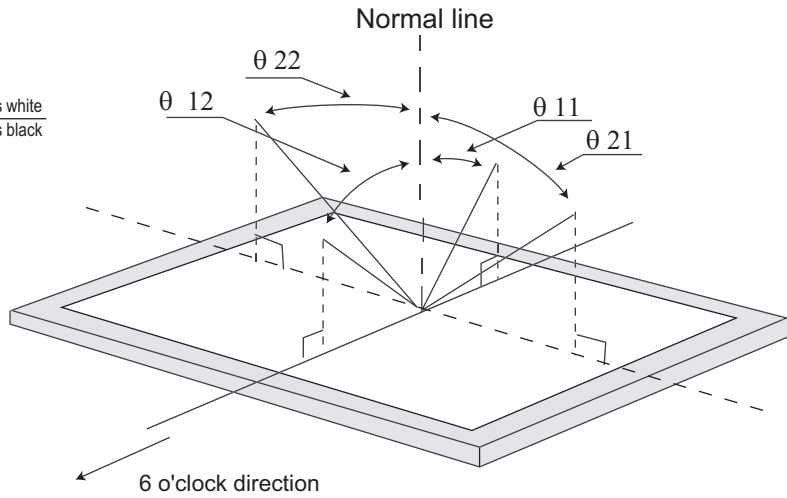

$$\delta W = \frac{\text{Maximum Luminance of five points (brightness)}}{\text{Minimum Luminance of five points (brightness)}}$$

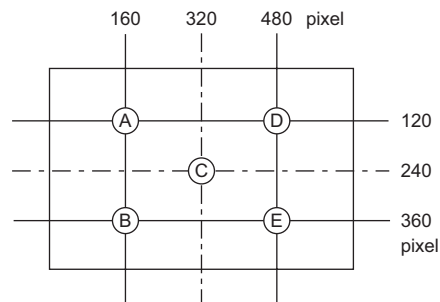
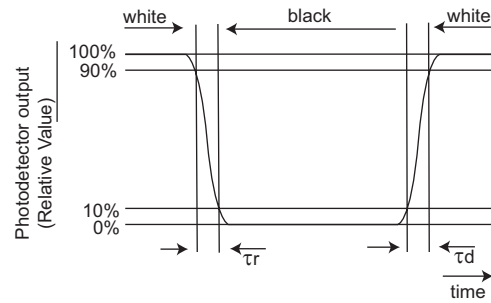



DISPLAY QUALITY

The display quality of the color TFT-LCD module shall be in compliance with the Incoming Inspection Standard.

HANDLING PRECAUTIONS

1. Be sure to turn off the power supply when inserting or disconnecting the cable.
2. Design the cabinet so that the module can be installed without any extra stress such as warp or twist.
3. Since the front polarizer is easily damaged, pay attention to avoid rubbing with something hard or sharp.
4. Wipe off water drop immediately. Long contact with water may cause discoloration or spots.
5. When the panel surface is soiled, use an absorbent cotton or other soft cloth to wipe it off.
6. Since the panel is made of glass and refined wires and components, it may break, crack or internal wire breaking if dropped or bumped on hard surface. Handle with care.
7. Since CMOS LSI is used in this module, make certain one is grounded when handling.
8. Observe all other precautionary requirements in handling components.
9. This module has its circuitry PCBs on the rear side and should be carefully handled in order to avoid being stressed.

10. Laminated film is attached to the module surface to prevent it from being scratched. Before use, peel the film off slowly, with strict attention to electrostatic charges. Ionized air shall be blown over during the action. Blow off 'dust' on the polarizer by using an ionized nitrogen gun.
11. Connect GND to 4 place of mounting holes to stabilize against EMI and external noise
12. The high voltage portions on the backlight are very dangerous. Careless handling may lead to electrical shock.

PACKING FORM

1. Piling number of cartons : MAX 8
2. Package quantity in one carton: 20pcs
3. Carton size: 483(W) x 275(D) x 330(H)mm
4. Total mass of 1 carton filled with full modules : 10.5kg

OTHERS

1. Disassembling the module can cause permanent damage and should be avoided.
2. Image retention may occur when a fixed pattern is displayed for a long time.
3. Do not use LCD module in the atmosphere of corrosive gasses, such as sulfide gas or chlorine gases, which can damage the display.

RELIABILITY TEST ITEMS

No.	Test items	Conditions	
1	High temperature storage test	t _A =70°C	240h
2	Low temperature storage test	t _A =-25°C	240h
3	High temperature and high humidity operating test	t _A =40°C, 95%RH (No condensation)	240h
4	High temperature operating test	t _A =60°C	240h
5	Low temperature operating test	t _A =-0°C	240h
6	Vibration Test (Non-operating)	Frequency	:10~57Hz/Vibration width (one side): 0.075mm :58~500Hz/Gravity: 9.8m/s ²
		Sweep time	:11 minutes
		Test Period	:3 hours (1 hour for each direction of X, Y, Z)
7	Shock test (non-operating)	Max gravity	:490m/s ²
		Pulse width	:11 minutes
		Direction	:±X, ±Y, ±Z (once for each direction.)

