

**GaAs SPST High Isolation Terminated Switch
0.3 - 4.0 GHz**

**MASWSS0148
V1**

Features

- High Isolation: 55 dB @ 2 GHz
- Insertion Loss: 1.6 dB @ 2 GHz
- Terminated RF Input in Isolation State
- Single Positive Control
- CMOS Compatible Logic
- Lead-Free 3 mm 12-Lead PQFN Package
- 100% Matte Tin Plating over Copper
- Halogen-Free “Green” Mold Compound
- RoHS* Compliant and 260°C Reflow Compatible

Description

M/A-COM’s MASWSS0148 is a GaAs monolithic single pole single throw (SPST) terminated switch in a lead-free 3 mm 12-lead PQFN plastic package. The MASWSS0148 is ideally suited for use where low power consumption, small size and high isolation are required.

Typical applications include PCS and GSM LO switching, switch matrices and switched filter banks in systems such as radio and cellular equipment.

The MASWSS0148 is fabricated using a mature 1-micron gate length GaAs MESFET process. The process features full chip passivation for increased performance and reliability.

Ordering Information

Part Number	Package
MASWSS0148TR-3000	3000 piece reel
MASWSS0148SMB	Sample Test Board

Note: Reference Application Note M513 for reel size information.

Schematic with Off-Chip Components¹

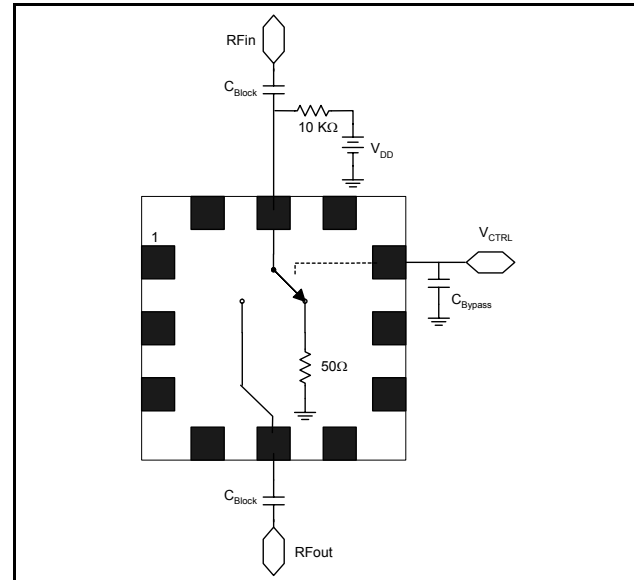

1. V_{DD} can be injected at either pin 5 or pin 11.

Pin Configuration

Pin No.	Function	Pin No.	Function
1	No Connection	7	No Connection
2	No Connection	8	No Connection
3	No Connection	9	V _{CTRL}
4	No Connection	10	No Connection
5	RF Output	11	RF Input
6	No Connection	12	No Connection
		13	Paddle ²

2. The exposed pad centered on the package bottom must be connected to RF and DC ground.

Absolute Maximum Ratings^{3,4}

Parameter	Absolute Maximum
Input Power	23 dBm (V _{DD} = V _{CTRL} = 5 V)
Operating Voltage (V _{DD} , V _{CTRL})	8.5 V
Operating Temperature	-40°C to +85°C
Storage Temperature	-65°C to +125°C

3. Exceeding any one or combination of these limits may cause permanent damage to this device.
4. M/A-COM does not recommend sustained operation near these survivability limits.

* Restrictions on Hazardous Substances, European Union Directive 2002/95/EC.

**GaAs SPST High Isolation Terminated Switch
0.3 - 4.0 GHz**

**MASWSS0148
V1**

Electrical Specifications: $T_A = 25^\circ\text{C}$, $V_{DD} = 5\text{ V}$, $V_{CTRL} = 0 / 5\text{ V}$, 100 pF capacitors, $Z_0 = 50\ \Omega$ ⁵

Parameter	Test Conditions	Units	Min.	Typ.	Max.
Insertion Loss ⁶	0.3 - 1.0 GHz	dB	—	1.5	1.7
	1.0 - 2.0 GHz	dB	—	1.6	—
	2.0 - 3.0 GHz	dB	—	1.7	—
	3.0 - 4.0 GHz	dB	—	1.75	—
Isolation	1.0 GHz	dB	50	55	—
	2.0 GHz	dB	—	55	—
	3.0 GHz	dB	—	48	—
	4.0 GHz	dB	—	40	—
Return Loss	Insertion Loss State, 0.3 - 4.0 GHz	dB	—	17	—
Input Return Loss	Isolation State	dB	—	20	—
Input 1 dB Compression	—	dBm	—	27	—
Trise, Tfall	10% to 90% RF	μS	—	3	—
	90% to 10% RF	μS	—	0.3	—
Ton, Toff	50% Control to 90% RF	μS	—	3.5	—
	50% Control to 10% RF	μS	—	0.4	—
Transients	In-Band	mV	—	20	—
Input IP ₂	2-Tone, 5 MHz spacing, +10 dBm / tone	dBm	—	72	—
Input IP ₃	2-Tone, 5 MHz spacing, +10 dBm / tone	dBm	—	49	—
Current (I _{CTRL})	Input Power = 10 dBm	μA	—	1	6
Current (I _{DD})	Input Power = 10 dBm	μA	—	1	6

5. For positive voltage control, external DC blocking capacitors are required on all RF ports.

6. Insertion loss can be optimized by varying the DC blocking capacitor value, e.g. 1000 pF for 300 MHz - 1 GHz, 39 pF for 0.5 GHz - 4 GHz.

Truth Table ^{7,8}

V _{CTRL}	RFin	RFout
0	50 Ω Termination	Open
1	RFout	RFin

7. Differential voltage, V(state 1) - V(state 0), must be +2.5 V minimum and must not exceed 8.5 V.

8. 0 = 0 V \pm 0.2 V, 1 = V_{DD} = 2.5 V to 8.5 V

Handling Procedures

Please observe the following precautions to avoid damage:

Static Sensitivity

Gallium Arsenide Integrated Circuits are sensitive to electrostatic discharge (ESD) and can be damaged by static electricity. Proper ESD control techniques should be used when handling these devices.

**GaAs SPST High Isolation Terminated Switch
0.3 - 4.0 GHz**

**MASWSS0148
V1**

Typical Performance Curves ($V_{DD} = 5\text{ V}$, $V_{CTRL} = 0 / 5\text{ V}$, 100 pF capacitors)

Insertion Loss

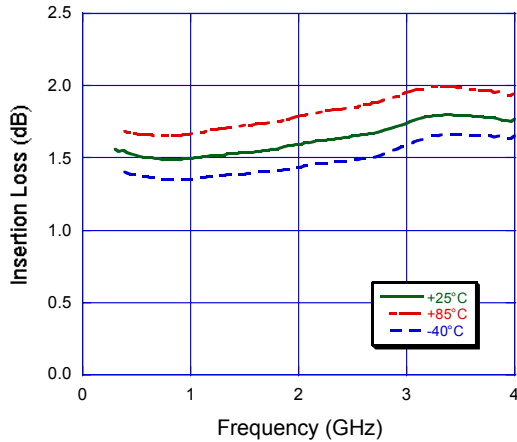

Isolation

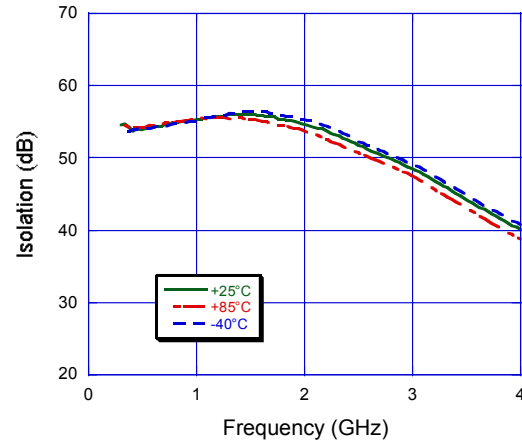

Return Loss (Insertion Loss State)

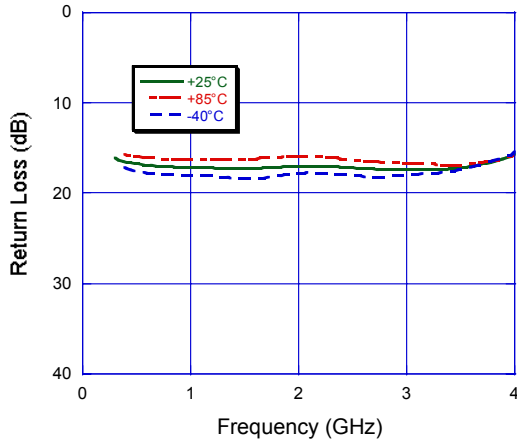

Input Return Loss (Isolation State)

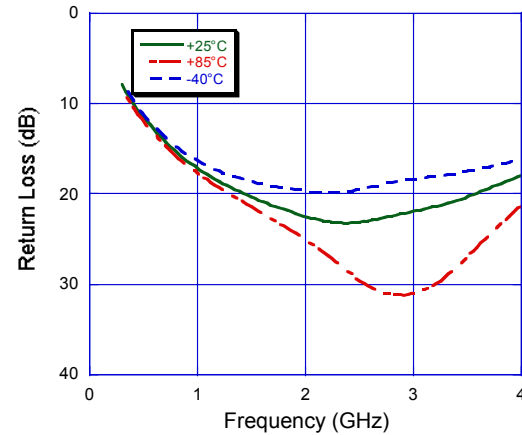

P1dB

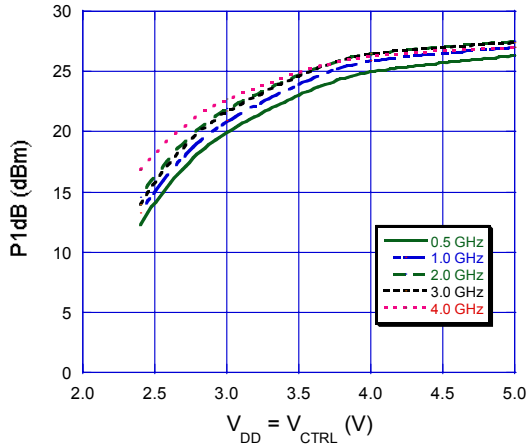

P0.1dB

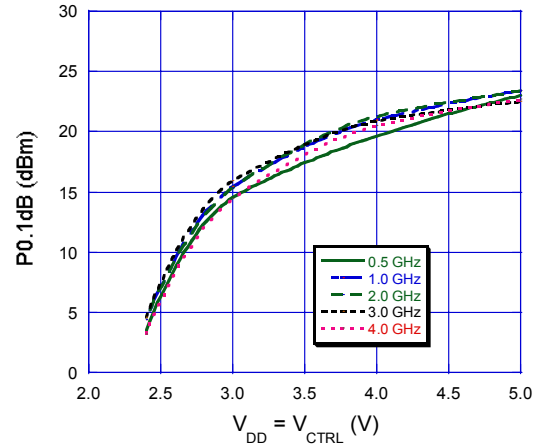

**GaAs SPST High Isolation Terminated Switch
0.3 - 4.0 GHz**

**MASWSS0148
V1**

Typical Performance Curves ($V_{DD} = 5\text{ V}$, $V_{CTRL} = 0 / 5\text{ V}$, 100 pF capacitors)

IP3

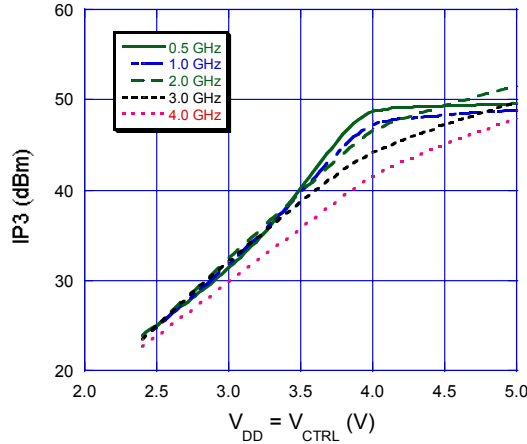

Lead-Free 3 mm 12-Lead PQFN†

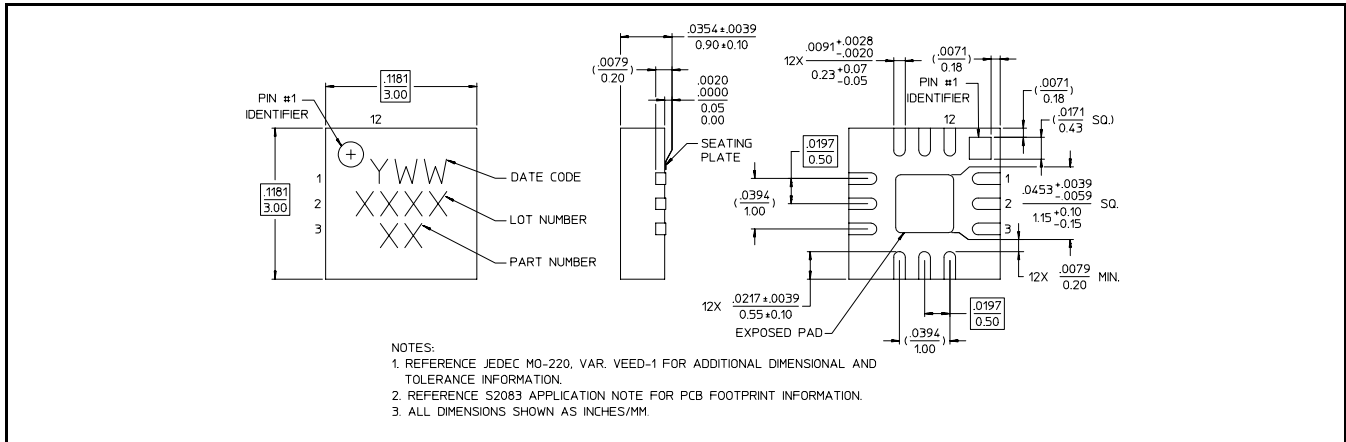

† Reference Application Note M538 for lead-free solder reflow recommendations.