

Version 2.0

Features

- High operating temperature
- High output voltage
- Robust cylindrical housing
- Biasing magnet build in
- Signal amplitude independent of speed
- Easily connectable

Typical Applications

- Detection of speed
- Detection of position
- Detection of sense of rotation
- Angle encoder
- Linear position sensing

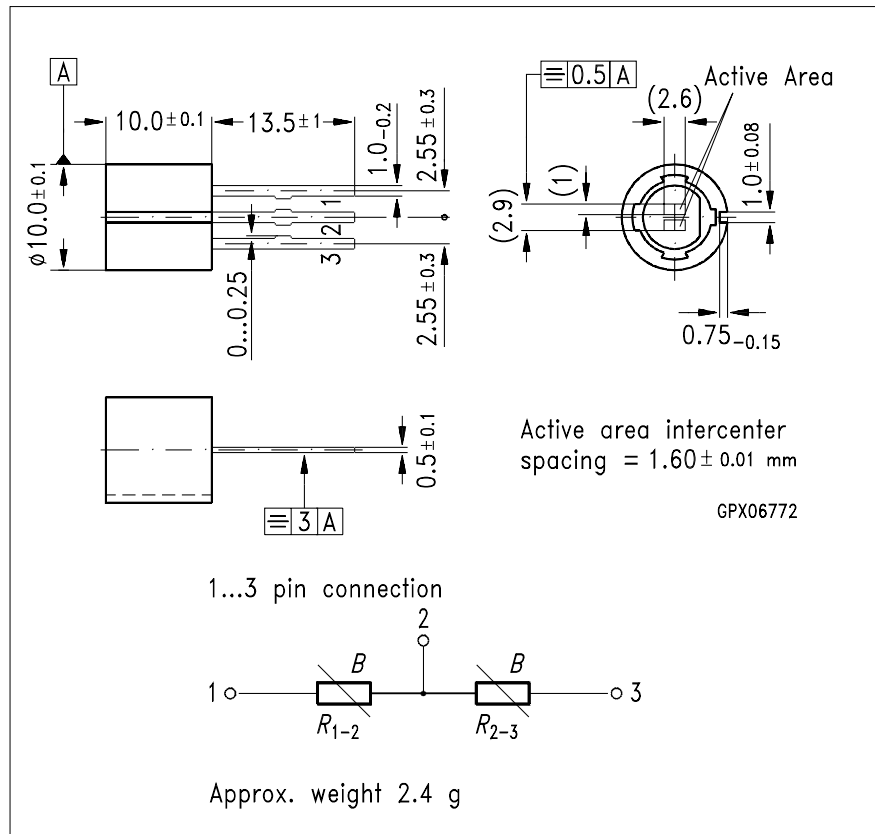

Dimensions in mm

Type	Ordering Code
FP 210 D 250-22	Q65210-D250-W5

The differential magneto-resistive sensor FP 210 D 250-22 consists of two series coupled D-type InSb/NiSb semiconductor resistors. The resistance value of the MRs, which are mounted onto an insulated ferrite substrate, can be magnetically controlled. The sensor is encapsulated in a plastic package with three in-line contacts extending from the base. The basic resistance of the total system in the unbiased state is $2 \times 250 \Omega$. A permanent magnet which supplies a biasing magnetic field is built into the housing.

Absolute Maximum Ratings

Parameter	Symbol	Limit Values	Unit
Operating temperature	T_A	- 40 / + 140	°C
Storage temperature	T_{stg}	- 40 / + 150	°C
Power dissipation ¹⁾	P_{tot}	400	mW
Supply voltage ²⁾	V_{IN}	7.5	V
Insulation voltage between terminals and casing	V_I	> 100	V
Thermal conductivity	G_{thA}	≥ 5	mW/K

Electrical Characteristics ($T_A = 25\text{ °C}$)

Nominal supply voltage	$V_{IN\ N}$	5	V
Total resistance, ($\delta = \infty$, $I \leq 1\text{ mA}$)	R_{1-3}	1000...1600	Ω
Center symmetry ³⁾ ($\delta = \infty$)	M	≤ 10	%
Offset voltage ⁴⁾ (at $V_{IN\ N}$ and $\delta = \infty$)	V_0	≤ 130	mV
Open circuit output voltage ⁵⁾ (at $V_{IN\ N}$ and $\delta = 0.2\text{ mm}$)	$V_{out\ pp}$	> 1100	mV
Cut-off frequency	f_c	> 20	kHz

Measuring Arrangements

By approaching a soft iron part close to the sensor a change in its resistance is obtained. The potential divider circuit of the magneto resistor causes a reduction in the temperature dependence of the output voltage V_{OUT} .

1) Corresponding to diagram $P_{tot} = f(T_A)$

2) Corresponding to diagram $V_{IN} = f(T_A)$

3)

$$M = \frac{R_{1-2} - R_{2-3}}{R_{1-2}} \times 100\% \text{ for } R_{1-2} > R_{2-3}$$

4) Corresponding to measuring circuit in **Fig. 2**

5) Corresponding to measuring circuit in **Fig. 2** and arrangement as shown in **Fig. 1**

1. Digital Revolution Counting

For digital revolution counting, the sensor should be actuated by a magnetically soft iron toothed wheel. The tooth spacing should correspond to about twice the magneto resistor intercenter spacing (see **Figure 1**).

The two resistors of the sensor are supplemented by two additional resistors in order to obtain the sensor output voltage as a bridge voltage V_{OUT} . The output voltage V_{OUT} without excitation then is 0 V when the offset is compensated.

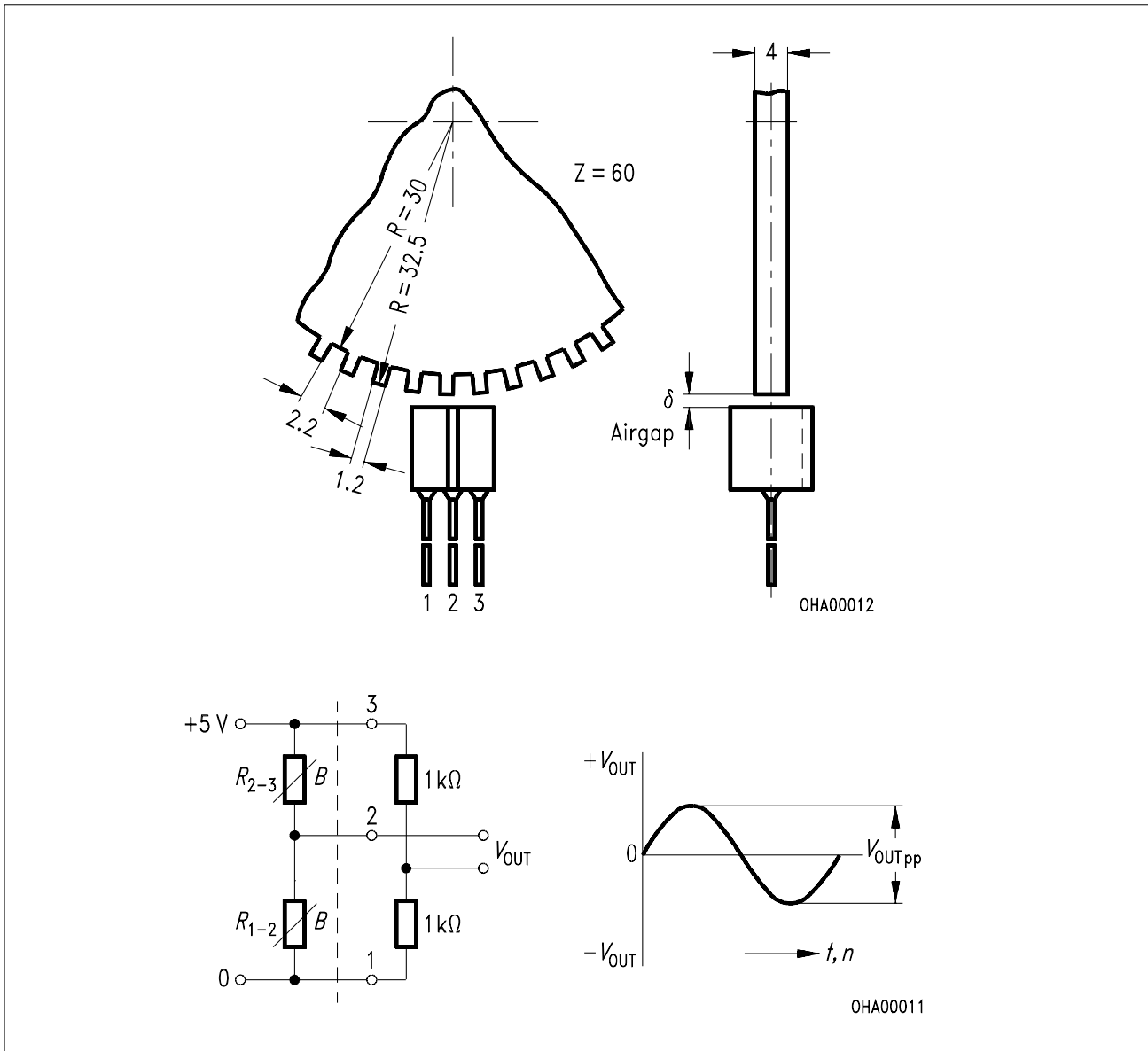

Figure 1
Schematic Representation of a Toothed Wheel actuating an FP 210 D 250-22

Figure 2
Measuring Circuit and Output Voltage V_{OUT} Waveform

2. Linear Distance Measurement

To convert small distances into a proportional electric signal, a small soft iron part of definite width (e.g. $b = 1.8 \text{ mm}$) is moved over the face of the sensor.

Proportional signals for distances up to 1.5 mm can be obtained in this way. The sinusoidal output signal gives a voltage proportional to distance in the zero crossover region (see **Figure 3**).

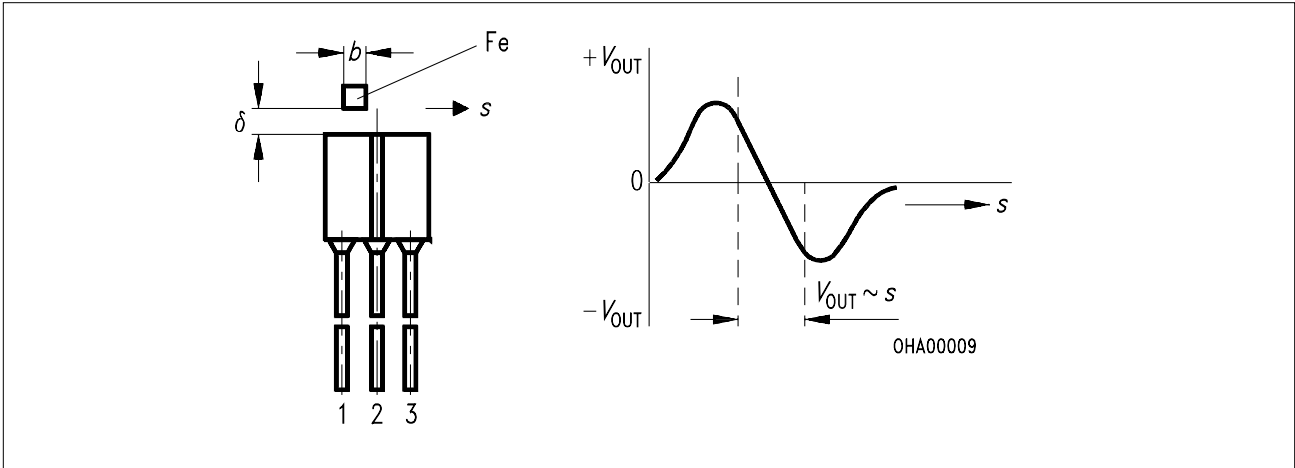
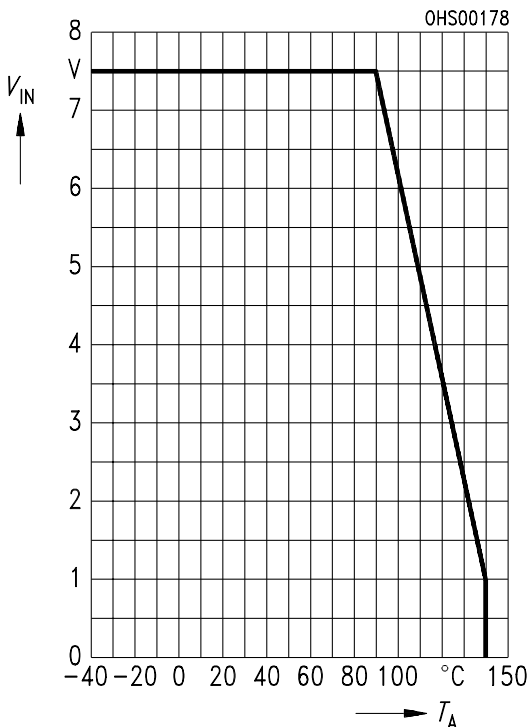

Figure 3
Arrangement for Analogue Application

Maximum supply voltage versus temperature

$$V_{IN} = f(T_A), \delta = \infty$$



Output voltage (typical) versus temperature $V_{OUTpp} = f(T_A)$, $\delta = 0.2 \text{ mm}$
 V_{OUTpp} at $T_A = 25 \text{ }^\circ\text{C} \hat{=} 100\%$

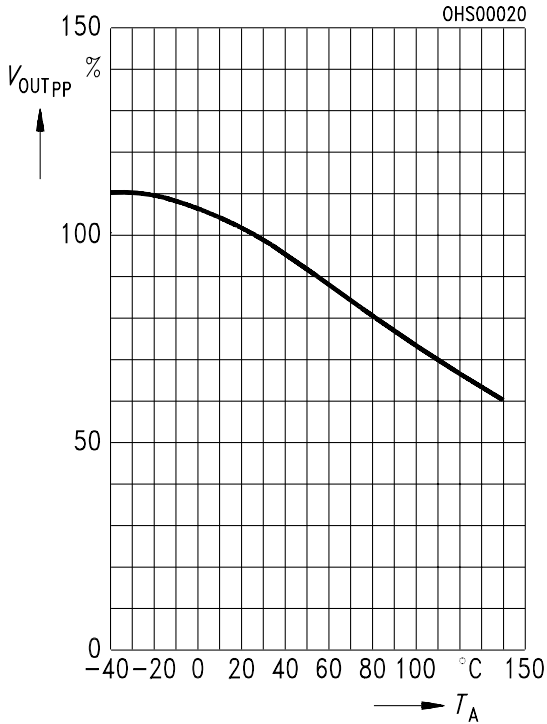

Output voltage (typical) versus airgap $V_{OUTpp} = f(\delta)$, $T_A = 25 \text{ }^\circ\text{C}$
 V_{OUTpp} at $\delta = 0.2 \text{ mm} \hat{=} 100\%$

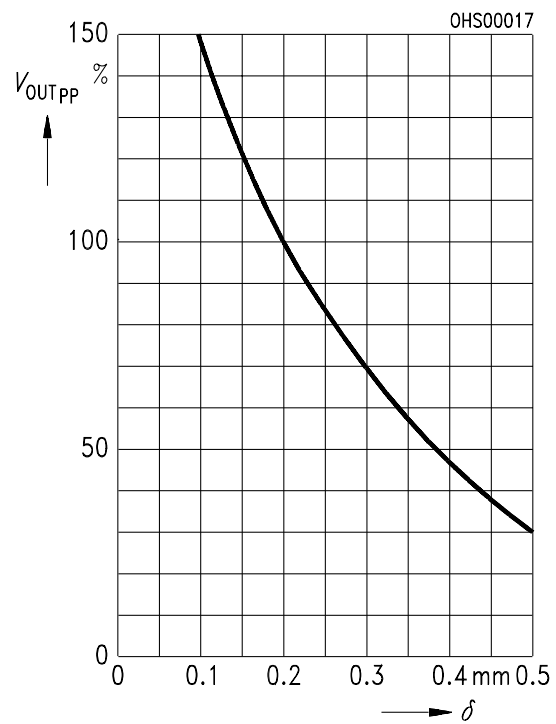

Total resistance (typical) versus temperature
 $R_{1-3} = f(T_A)$, $\delta = \infty$

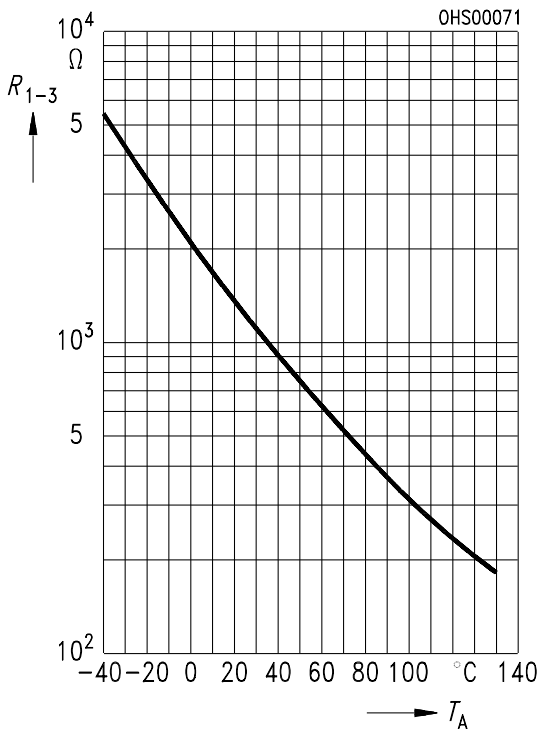

Max. power dissipation versus temperature
 $P_{tot} = f(T_A)$, $\delta = \infty$

