



PRELIMINARY

**CY7C1355C
CY7C1357C**

9-Mbit (256K x 36/512K x 18) Flow-Through SRAM with NoBL™ Architecture

Features

- **No Bus Latency™ (NoBL™) architecture eliminates dead cycles between write and read cycles.**
- **Can support up to 133-MHz bus operations with zero wait states**
 - Data is transferred on every clock
- **Pin compatible and functionally equivalent to ZBT™ devices**
- **Internally self-timed output buffer control to eliminate the need to use OE**
- **Registered inputs for flow-through operation**
- **Byte Write capability**
- **3.3V/2.5V I/O power supply**
- **Fast clock-to-output times**
 - 6.5 ns (for 133-MHz device)
 - 7.0 ns (for 117-MHz device)
 - 7.5 ns (for 100-MHz device)
- **Clock Enable (CEN) pin to enable clock and suspend operation**
- **Synchronous self-timed writes**
- **Asynchronous Output Enable**
- **Offered in JEDEC-standard 100 TQFP, 119-Ball BGA and 165-Ball fBGA packages**
- **Three chip enables for simple depth expansion.**
- **Automatic Power-down feature available using ZZ mode or CE deselect**
- **JTAG boundary scan for BGA and fBGA packages**
- **Burst Capability—linear or interleaved burst order**
- **Low standby power**

Selection Guide

	133 MHz	117 MHz	100 MHz	Unit
Maximum Access Time	6.5	7.0	7.5	ns
Maximum Operating Current	250	220	180	mA
Maximum CMOS Standby Current	30	30	30	mA

Note:

1. For best-practices recommendations, please refer to the Cypress application note *System Design Guidelines* on www.cypress.com.

Functional Description^[1]

The CY7C1355C/CY7C1357C is a 3.3V, 256K x 36/ 512K x 18 Synchronous Flow-through Burst SRAM designed specifically to support unlimited true back-to-back Read/Write operations without the insertion of wait states. The CY7C1355C/CY7C1357C is equipped with the advanced No Bus Latency (NoBL) logic required to enable consecutive Read/Write operations with data being transferred on every clock cycle. This feature dramatically improves the throughput of data through the SRAM, especially in systems that require frequent Write-Read transitions.

All synchronous inputs pass through input registers controlled by the rising edge of the clock. The clock input is qualified by the Clock Enable (CEN) signal, which when deasserted suspends operation and extends the previous clock cycle. Maximum access delay from the clock rise is 6.5 ns (133-MHz device).

Write operations are controlled by the two or four Byte Write Select (BW_X) and a Write Enable (WE) input. All writes are conducted with on-chip synchronous self-timed write circuitry.

Three synchronous Chip Enables (CE₁, CE₂, CE₃) and an asynchronous Output Enable (OE) provide for easy bank selection and output three-state control. In order to avoid bus contention, the output drivers are synchronously three-stated during the data portion of a write sequence.

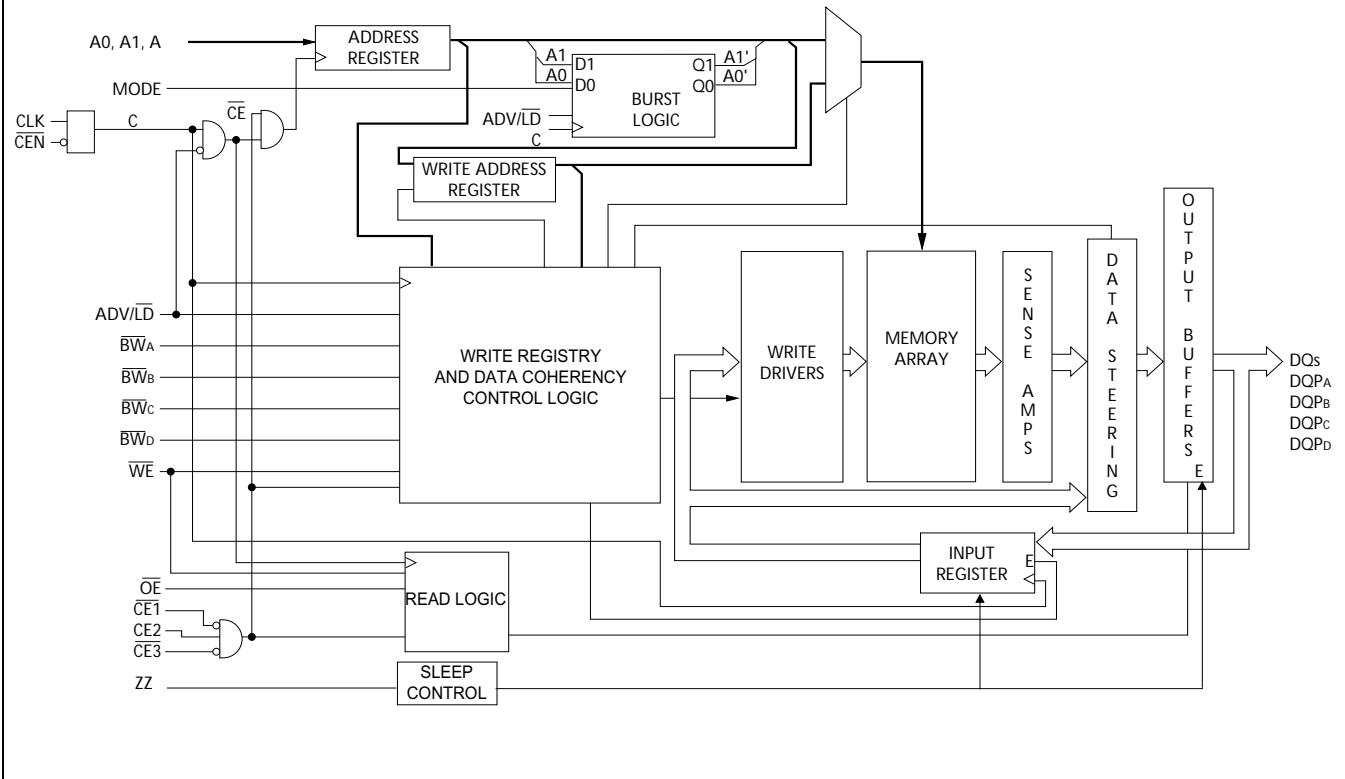
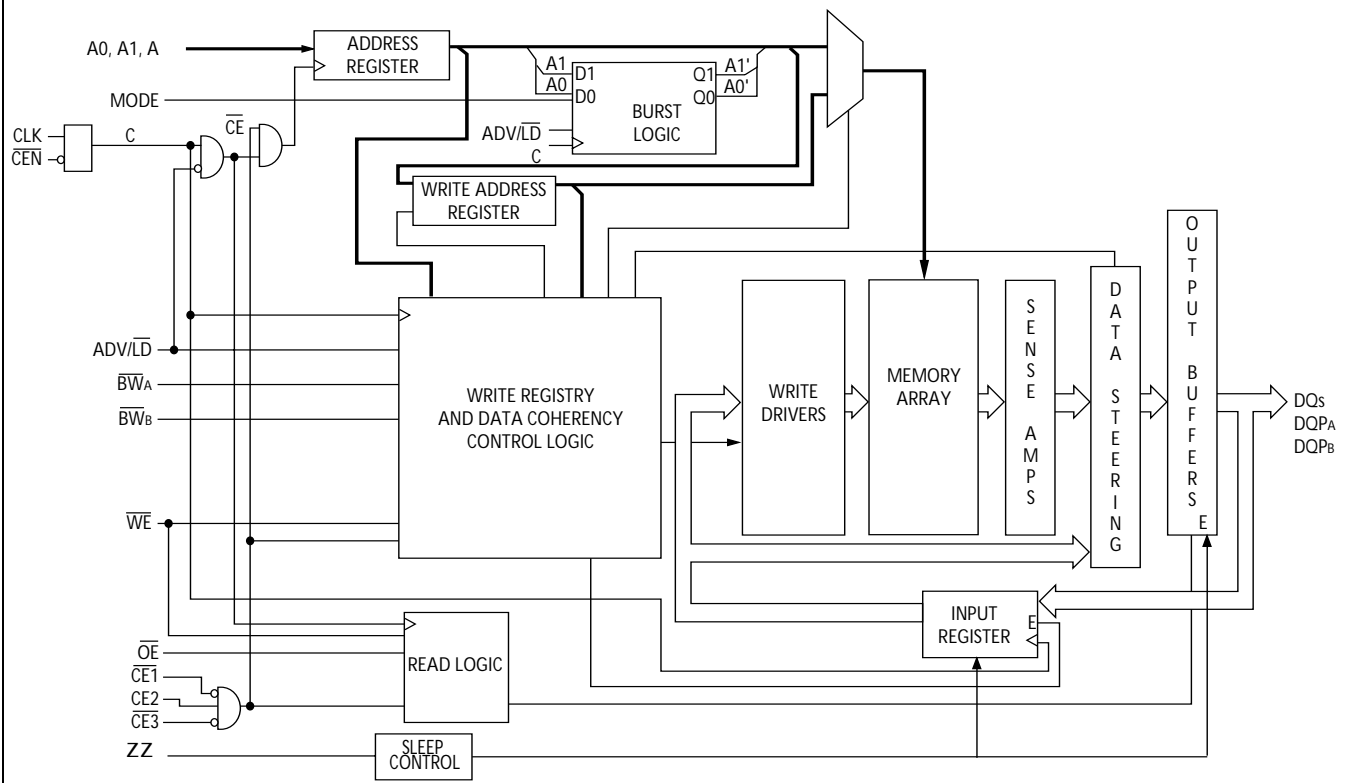
Logic Block Diagram – CY7C1355C (256K x 36)

Logic Block Diagram – CY7C1357C (512K x 18)

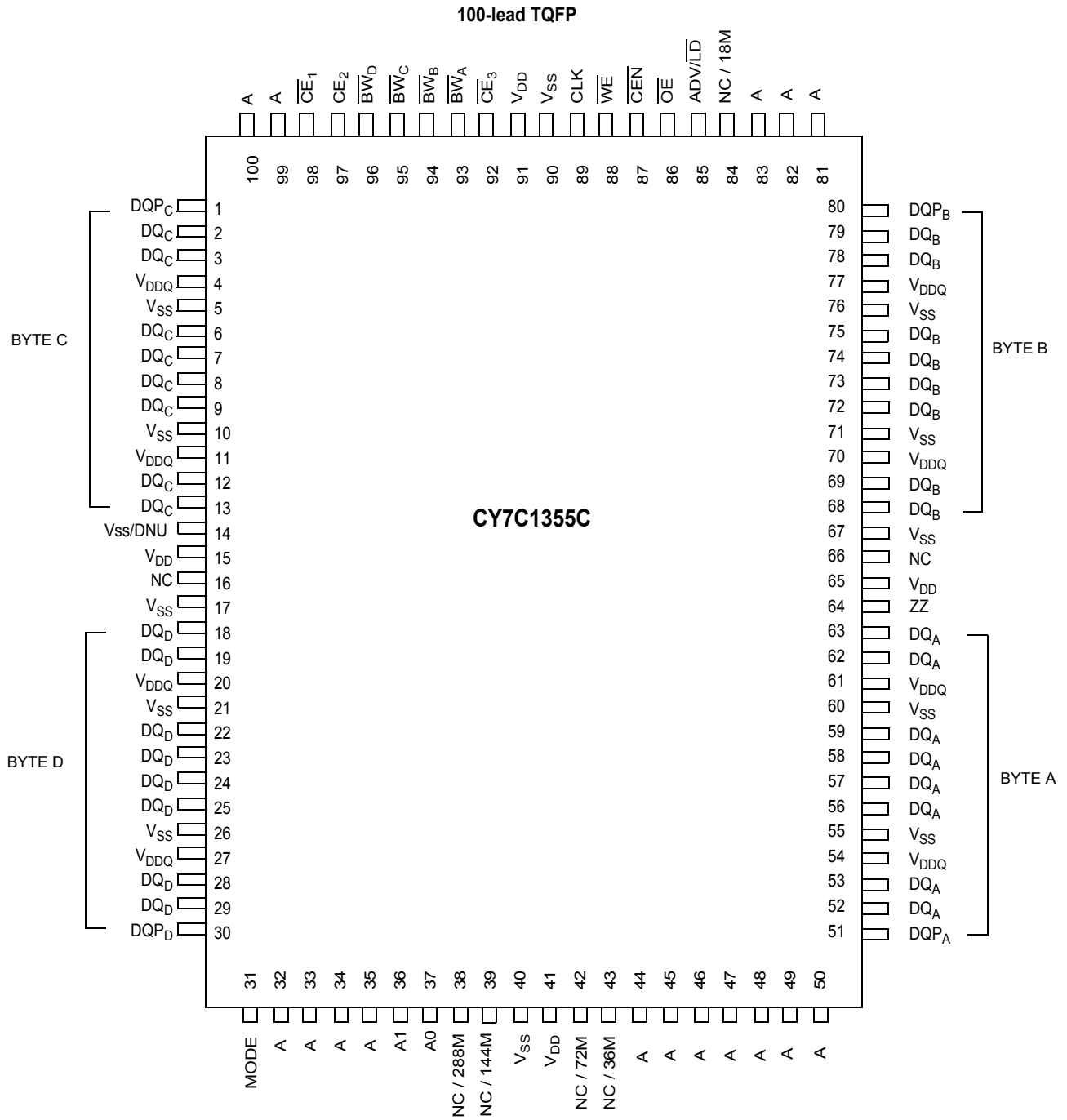
Pin Configurations





PRELIMINARY

**CY7C1355C
CY7C1357C**

Pin Configurations (continued)

100-lead TQFP

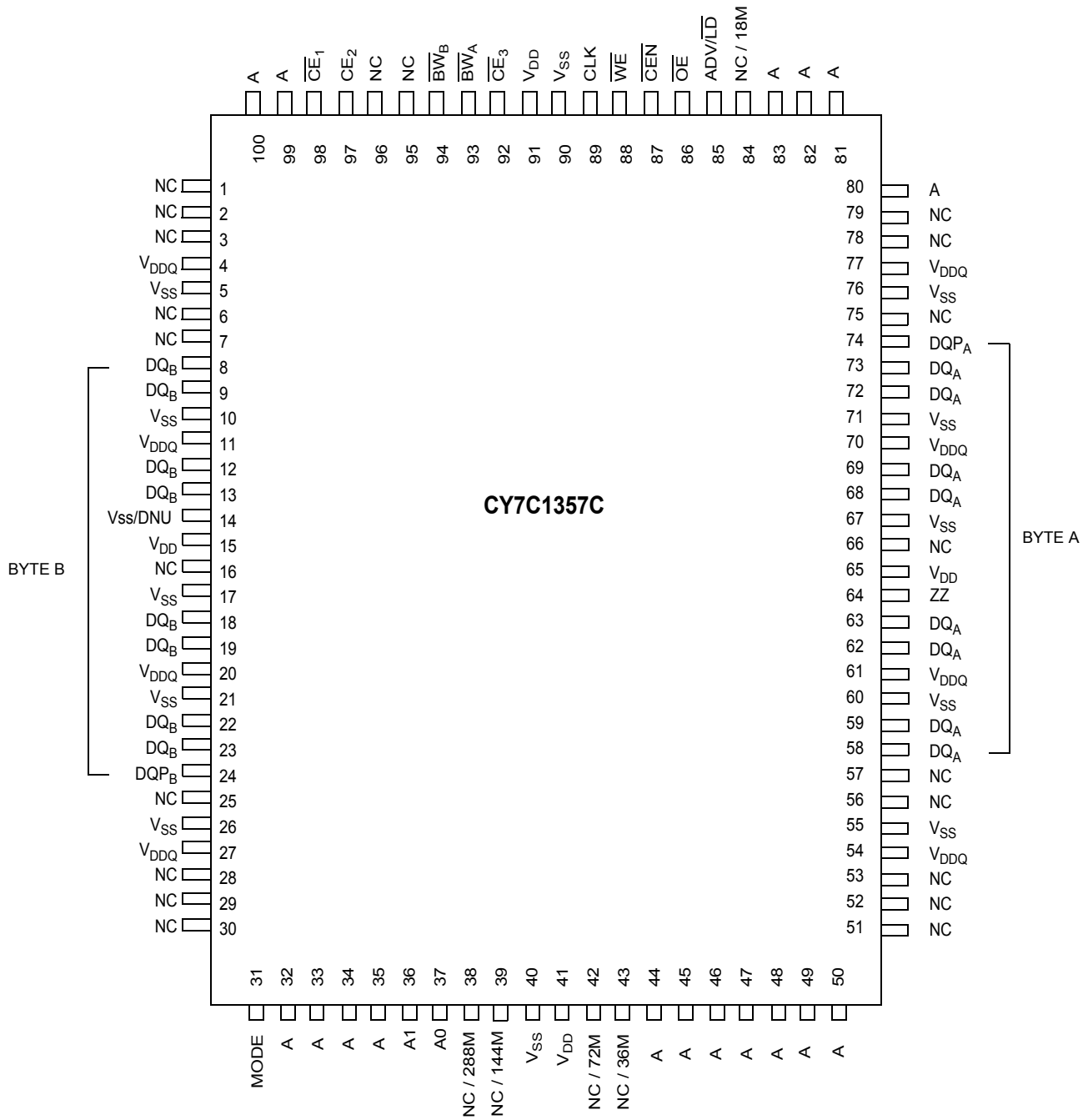



Pin Configurations (continued)

119-ball BGA (3 Chip Enables with JTAG)

CY7C1355C (256K x 36)

	1	2	3	4	5	6	7
A	V _{DDQ}	A	A	NC / 18M	A	A	V _{DDQ}
B	NC	CE ₂	A	ADV/LD	A	\overline{CE}_3	NC
C	NC	A	A	V _{DD}	A	A	NC
D	DQ _C	DQP _C	V _{SS}	NC	V _{SS}	DQP _B	DQ _B
E	DQ _C	DQ _C	V _{SS}	\overline{CE}_1	V _{SS}	DQ _B	DQ _B
F	V _{DDQ}	DQ _C	V _{SS}	\overline{OE}	V _{SS}	DQ _B	V _{DDQ}
G	DQ _C	DQ _C	\overline{BW}_C	A	\overline{BW}_B	DQ _B	DQ _B
H	DQ _C	DQ _C	V _{SS}	\overline{WE}	V _{SS}	DQ _B	DQ _B
J	V _{DDQ}	V _{DD}	NC	V _{DD}	NC	V _{DD}	V _{DDQ}
K	DQ _D	DQ _D	V _{SS}	CLK	V _{SS}	DQ _A	DQ _A
L	DQ _D	DQ _D	\overline{BW}_D	NC	\overline{BW}_A	DQ _A	DQ _A
M	V _{DDQ}	DQ _D	V _{SS}	\overline{CEN}	V _{SS}	DQ _A	V _{DDQ}
N	DQ _D	DQ _D	V _{SS}	A1	V _{SS}	DQ _A	DQ _A
P	DQ _D	DQP _D	V _{SS}	A0	V _{SS}	DQP _A	DQ _A
R	NC	A	MODE	V _{DD}	NC	A	NC
T	NC	NC / 72M	A	A	A	NC / 36M	ZZ
U	V _{DDQ}	TMS	TDI	TCK	TDO	NC	V _{DDQ}

CY7C1357C (512K x 18)

	1	2	3	4	5	6	7
A	V _{DDQ}	A	A	NC / 18M	A	A	V _{DDQ}
B	NC	CE ₂	A	ADV/LD	A	\overline{CE}_3	NC
C	NC	A	A	V _{DD}	A	A	NC
D	DQ _B	NC	V _{SS}	NC	V _{SS}	DQP _A	NC
E	NC	DQ _B	V _{SS}	\overline{CE}_1	V _{SS}	NC	DQ _A
F	V _{DDQ}	NC	V _{SS}	\overline{OE}	V _{SS}	DQ _A	V _{DDQ}
G	NC	DQ _B	\overline{BW}_B	A	V _{SS}	NC	DQ _A
H	DQ _B	NC	V _{SS}	\overline{WE}	V _{SS}	DQ _A	NC
J	V _{DDQ}	V _{DD}	NC	V _{DD}	NC	V _{DD}	V _{DDQ}
K	NC	DQ _B	V _{SS}	CLK	V _{SS}	NC	DQ _A
L	DQ _B	NC	V _{SS}	NC	\overline{BW}_A	DQ _A	NC
M	V _{DDQ}	DQ _B	V _{SS}	\overline{CEN}	V _{SS}	NC	V _{DDQ}
N	DQ _B	NC	V _{SS}	A1	V _{SS}	DQ _A	NC
P	NC	DQP _B	V _{SS}	A0	V _{SS}	NC	DQ _A
R	NC	A	MODE	V _{DD}	NC	A	NC
T	NC / 72M	A	A	NC / 36M	A	A	ZZ
U	V _{DDQ}	TMS	TDI	TCK	TDO	NC	V _{DDQ}



Pin Configurations (continued)

165-ball fBGA (3 Chip enable with JTAG)
CY7C1355C (256K x 36)

	1	2	3	4	5	6	7	8	9	10	11
A	NC / 288M	A	\overline{CE}_1	\overline{BW}_C	\overline{BW}_B	\overline{CE}_3	\overline{CEN}	ADV/LD	A	A	NC
B	NC	A	CE2	\overline{BW}_D	\overline{BW}_A	CLK	\overline{WE}	\overline{OE}	NC / 18M	A	NC / 144M
C	DQP _C	NC	V _{DDQ}	V _{SS}	V _{SS}	V _{SS}	V _{SS}	V _{SS}	V _{DDQ}	NC	DQP _B
D	DQ _C	DQ _C	V _{DDQ}	V _{DD}	V _{SS}	V _{SS}	V _{SS}	V _{DD}	V _{DDQ}	DQ _B	DQ _B
E	DQ _C	DQ _C	V _{DDQ}	V _{DD}	V _{SS}	V _{SS}	V _{SS}	V _{DD}	V _{DDQ}	DQ _B	DQ _B
F	DQ _C	DQ _C	V _{DDQ}	V _{DD}	V _{SS}	V _{SS}	V _{SS}	V _{DD}	V _{DDQ}	DQ _B	DQ _B
G	DQ _C	DQ _C	V _{DDQ}	V _{DD}	V _{SS}	V _{SS}	V _{SS}	V _{DD}	V _{DDQ}	DQ _B	DQ _B
H	NC	NC	NC	V _{DD}	V _{SS}	V _{SS}	V _{SS}	V _{DD}	NC	NC	ZZ
J	DQ _D	DQ _D	V _{DDQ}	V _{DD}	V _{SS}	V _{SS}	V _{SS}	V _{DD}	V _{DDQ}	DQ _A	DQ _A
K	DQ _D	DQ _D	V _{DDQ}	V _{DD}	V _{SS}	V _{SS}	V _{SS}	V _{DD}	V _{DDQ}	DQ _A	DQ _A
L	DQ _D	DQ _D	V _{DDQ}	V _{DD}	V _{SS}	V _{SS}	V _{SS}	V _{DD}	V _{DDQ}	DQ _A	DQ _A
M	DQ _D	DQ _D	V _{DDQ}	V _{DD}	V _{SS}	V _{SS}	V _{SS}	V _{DD}	V _{DDQ}	DQ _A	DQ _A
N	DQP _D	NC	V _{DDQ}	V _{SS}	NC	NC	NC	V _{SS}	V _{DDQ}	NC	DQP _A
P	NC	NC / 72M	A	A	TDI	A1	TDO	A	A	A	NC
R	MODE	NC / 36M	A	A	TMS	A0	TCK	A	A	A	A

CY7C1357C (512K x 18)

	1	2	3	4	5	6	7	8	9	10	11
A	NC / 288M	A	\overline{CE}_1	\overline{BW}_B	NC	\overline{CE}_3	\overline{CEN}	ADV/LD	A	A	A
B	NC	A	CE2	NC	\overline{BW}_A	CLK	\overline{WE}	\overline{OE}	NC / 18M	A	NC / 144M
C	NC	NC	V _{DDQ}	V _{SS}	V _{SS}	V _{SS}	V _{SS}	V _{SS}	V _{DDQ}	NC	DQP _A
D	NC	DQ _B	V _{DDQ}	V _{DD}	V _{SS}	V _{SS}	V _{SS}	V _{DD}	V _{DDQ}	NC	DQ _A
E	NC	DQ _B	V _{DDQ}	V _{DD}	V _{SS}	V _{SS}	V _{SS}	V _{DD}	V _{DDQ}	NC	DQ _A
F	NC	DQ _B	V _{DDQ}	V _{DD}	V _{SS}	V _{SS}	V _{SS}	V _{DD}	V _{DDQ}	NC	DQ _A
G	NC	DQ _B	V _{DDQ}	V _{DD}	V _{SS}	V _{SS}	V _{SS}	V _{DD}	V _{DDQ}	NC	DQ _A
H	NC	NC	NC	V _{DD}	V _{SS}	V _{SS}	V _{SS}	V _{DD}	NC	NC	ZZ
J	DQ _B	NC	V _{DDQ}	V _{DD}	V _{SS}	V _{SS}	V _{SS}	V _{DD}	V _{DDQ}	DQ _A	NC
K	DQ _B	NC	V _{DDQ}	V _{DD}	V _{SS}	V _{SS}	V _{SS}	V _{DD}	V _{DDQ}	DQ _A	NC
L	DQ _B	NC	V _{DDQ}	V _{DD}	V _{SS}	V _{SS}	V _{SS}	V _{DD}	V _{DDQ}	DQ _A	NC
M	DQ _B	NC	V _{DDQ}	V _{DD}	V _{SS}	V _{SS}	V _{SS}	V _{DD}	V _{DDQ}	DQ _A	NC
N	DQP _B	NC	V _{DDQ}	V _{SS}	NC	NC	NC	V _{SS}	V _{DDQ}	NC	NC
P	NC	NC / 72M	A	A	TDI	A1	TDO	A	A	A	NC
R	MODE	NC / 36M	A	A	TMS	A0	TCK	A	A	A	A

Pin Definitions

Name	I/O	Description
A ₀ , A ₁ , A	Input-Synchronous	Address Inputs used to select one of the address locations. Sampled at the rising edge of the CLK. A _[1:0] are fed to the two-bit burst counter.
\overline{BW}_A , \overline{BW}_B \overline{BW}_C , \overline{BW}_D	Input-Synchronous	Byte Write Inputs, active LOW. Qualified with \overline{WE} to conduct Writes to the SRAM. Sampled on the rising edge of CLK.
\overline{WE}	Input-Synchronous	Write Enable Input, active LOW. Sampled on the rising edge of CLK if \overline{CEN} is active LOW. This signal must be asserted LOW to initiate a write sequence.
ADV/ \overline{LD}	Input-Synchronous	Advance/Load Input. Used to advance the on-chip address counter or load a new address. When HIGH (and \overline{CEN} is asserted LOW) the internal burst counter is advanced. When LOW, a new address can be loaded into the device for an access. After being deselected, ADV/LD should be driven LOW in order to load a new address.
CLK	Input-Clock	Clock Input. Used to capture all synchronous inputs to the device. CLK is qualified with \overline{CEN} . CLK is only recognized if \overline{CEN} is active LOW.
\overline{CE}_1	Input-Synchronous	Chip Enable 1 Input, active LOW. Sampled on the rising edge of CLK. Used in conjunction with \overline{CE}_2 , and \overline{CE}_3 to select/deselect the device.
\overline{CE}_2	Input-Synchronous	Chip Enable 2 Input, active HIGH. Sampled on the rising edge of CLK. Used in conjunction with \overline{CE}_1 and \overline{CE}_3 to select/deselect the device.
\overline{CE}_3	Input-Synchronous	Chip Enable 3 Input, active LOW. Sampled on the rising edge of CLK. Used in conjunction with \overline{CE}_1 and \overline{CE}_2 to select/deselect the device.
\overline{OE}	Input-Asynchronous	Output Enable, asynchronous input, active LOW. Combined with the synchronous logic block inside the device to control the direction of the I/O pins. When LOW, the I/O pins are allowed to behave as outputs. When deasserted HIGH, I/O pins are three-stated, and act as input data pins. \overline{OE} is masked during the data portion of a write sequence, during the first clock when emerging from a deselected state, when the device has been deselected.
\overline{CEN}	Input-Synchronous	Clock Enable Input, active LOW. When asserted LOW the Clock signal is recognized by the SRAM. When deasserted HIGH the Clock signal is masked. Since deasserting \overline{CEN} does not deselect the device, \overline{CEN} can be used to extend the previous cycle when required.
ZZ	Input-Asynchronous	ZZ "Sleep" Input. This active HIGH input places the device in a non-time critical "sleep" condition with data integrity preserved. During normal operation, this pin can be connected to V _{SS} or left floating.
DQ _s	I/O-Synchronous	Bidirectional Data I/O lines. As inputs, they feed into an on-chip data register that is triggered by the rising edge of CLK. As outputs, they deliver the data contained in the memory location specified by the addresses presented during the previous clock rise of the Read cycle. The direction of the pins is controlled by \overline{OE} . When \overline{OE} is asserted LOW, the pins behave as outputs. When HIGH, DQ _s and DQP _x are placed in a three-state condition. The outputs are automatically three-stated during the data portion of a Write sequence, during the first clock when emerging from a deselected state, and when the device is deselected, regardless of the state of \overline{OE} .
DQP _x	I/O-Synchronous	Bidirectional Data Parity I/O Lines. Functionally, these signals are identical to DQ _s . During Write sequences, DQP _x is controlled by \overline{BW}_x correspondingly.
MODE	Input Strap Pin	Mode Input. Selects the burst order of the device. When tied to Gnd selects linear burst sequence. When tied to V _{DD} or left floating selects interleaved burst sequence.
V _{DD}	Power Supply	Power supply inputs to the core of the device.
V _{DDQ}	I/O Power Supply	Power supply for the I/O circuitry.
V _{SS}	Ground	Ground for the device.

Pin Definitions (continued)

Name	I/O	Description
TDO	JTAG serial output Synchronous	Serial data-out to the JTAG circuit. Delivers data on the negative edge of TCK. If the JTAG feature is not being utilized, this pin should be left unconnected. This pin is not available on TQFP packages.
TDI	JTAG serial input Synchronous	Serial data-In to the JTAG circuit. Sampled on the rising edge of TCK. If the JTAG feature is not being utilized, this pin can be left floating or connected to V_{DD} through a pull up resistor. This pin is not available on TQFP packages.
TMS	JTAG serial input Synchronous	Serial data-In to the JTAG circuit. Sampled on the rising edge of TCK. If the JTAG feature is not being utilized, this pin can be disconnected or connected to V_{DD} . This pin is not available on TQFP packages.
TCK	JTAG-Clock	Clock input to the JTAG circuitry. If the JTAG feature is not being utilized, this pin must be connected to V_{SS} . This pin is not available on TQFP packages.
NC	-	No Connects. Not internally connected to the die. 18M,36M, 72M, 144M and 288M are address expansion pins and are not internally connected to the die.
V_{SS} /DNU	Ground/DNU	This pin can be connected to Ground or should be left floating.

Functional Overview

The CY7C1355C/CY7C1357C is a synchronous flow-through burst SRAM designed specifically to eliminate wait states during Write-Read transitions. All synchronous inputs pass through input registers controlled by the rising edge of the clock. The clock signal is qualified with the Clock Enable input signal (CEN). If CEN is HIGH, the clock signal is not recognized and all internal states are maintained. All synchronous operations are qualified with $\overline{\text{CEN}}$. Maximum access delay from the clock rise (t_{CDV}) is 6.5 ns (133-MHz device).

Accesses can be initiated by asserting all three Chip Enables (CE_1 , CE_2 , CE_3) active at the rising edge of the clock. If Clock Enable (CEN) is active LOW and ADV/LD is asserted LOW, the address presented to the device will be latched. The access can either be a Read or Write operation, depending on the status of the Write Enable (WE). BW_X can be used to conduct Byte Write operations.

Write operations are qualified by the Write Enable ($\overline{\text{WE}}$). All writes are simplified with on-chip synchronous self-timed Write circuitry.

Three synchronous Chip Enables ($\overline{\text{CE}}_1$, CE_2 , $\overline{\text{CE}}_3$) and an asynchronous Output Enable (OE) simplify depth expansion. All operations (Reads, Writes, and Deselects) are pipelined. ADV/LD should be driven LOW once the device has been deselected in order to load a new address for the next operation.

Single Read Accesses

A read access is initiated when the following conditions are satisfied at clock rise: (1) CEN is asserted LOW, (2) CE_1 , CE_2 , and $\overline{\text{CE}}_3$ are ALL asserted active, (3) the Write Enable input signal WE is deasserted HIGH, and 4) ADV/LD is asserted LOW. The address presented to the address inputs is latched into the address register and presented to the memory array and control logic. The control logic determines that a read access is in progress and allows the requested data to propagate to the output buffers. The data is available within 6.5 ns (133-MHz device) provided OE is active LOW. After the first clock of the read access, the output buffers are controlled by $\overline{\text{OE}}$ and the internal control logic. $\overline{\text{OE}}$ must be driven LOW in order for the device to drive out the requested data. On the subsequent clock, another operation (Read/Write/Deselect) can be initiated. When the SRAM is deselected at clock rise by one of the chip enable signals, its output will be three-stated immediately.

Burst Read Accesses

The CY7C1355C/CY7C1357C has an on-chip burst counter that allows the user the ability to supply a single address and conduct up to four Reads without reasserting the address inputs. ADV/LD must be driven LOW in order to load a new address into the SRAM, as described in the Single Read Access section above. The sequence of the burst counter is determined by the MODE input signal. A LOW input on MODE selects a linear burst mode, a HIGH selects an interleaved burst sequence. Both burst counters use A0 and A1 in the burst sequence, and will wrap around when incremented sufficiently. A HIGH input on ADV/LD will increment the internal burst counter regardless of the state of chip enable inputs or WE. WE is latched at the beginning of a burst cycle. Therefore, the type of access (Read or Write) is maintained throughout the burst sequence.

Single Write Accesses

Write access are initiated when the following conditions are satisfied at clock rise: (1) $\overline{\text{CEN}}$ is asserted LOW, (2) $\overline{\text{CE}}_1$, CE_2 , and CE_3 are ALL asserted active, and (3) the Write signal WE is asserted LOW. The address presented to the address bus is loaded into the address register. The write signals are latched into the Control Logic block. The data lines are automatically three-stated regardless of the state of the OE input signal. This allows the external logic to present the data on DQs and DQP_X.

On the next clock rise the data presented to DQs and DQP_X (or a subset for byte write operations, see Truth Table for details) inputs is latched into the device and the write is complete. Additional accesses (Read/Write/Deselect) can be initiated on this cycle.

The data written during the Write operation is controlled by BW_X signals. The CY7C1355C/CY7C1357C provides byte write capability that is described in the Truth Table. Asserting the Write Enable input ($\overline{\text{WE}}$) with the selected Byte Write Select input will selectively write to only the desired bytes. Bytes not selected during a byte write operation will remain unaltered. A synchronous self-timed Write mechanism has been provided to simplify the Write operations. Byte Write capability has been included in order to greatly simplify Read/Modify/Write sequences, which can be reduced to simple Byte Write operations.

Because the CY7C1355C/CY7C1357C is a common I/O device, data should not be driven into the device while the outputs are active. The Output Enable (OE) can be deasserted HIGH before presenting data to the DQs and DQP_X inputs. Doing so will three-state the output drivers. As a safety precaution, DQs and DQP_X are automatically three-stated during the data portion of a write cycle, regardless of the state of OE.

Burst Write Accesses

The CY7C1355C/CY7C1357C has an on-chip burst counter that allows the user the ability to supply a single address and conduct up to four Write operations without reasserting the address inputs. ADV/LD must be driven LOW in order to load the initial address, as described in the Single Write Access section above. When ADV/LD is driven HIGH on the subsequent clock rise, the Chip Enables (CE_1 , CE_2 , and CE_3) and WE inputs are ignored and the burst counter is incremented. The correct BW_X inputs must be driven in each cycle of the burst write, in order to write the correct bytes of data.

Sleep Mode

The ZZ input pin is an asynchronous input. Asserting ZZ places the SRAM in a power conservation "sleep" mode. Two clock cycles are required to enter into or exit from this "sleep" mode. While in this mode, data integrity is guaranteed. Accesses pending when entering the "sleep" mode are not considered valid nor is the completion of the operation guaranteed. The device must be deselected prior to entering the "sleep" mode. CE_1 , CE_2 , and CE_3 , must remain inactive for the duration of t_{ZZREC} after the ZZ input returns LOW.



**Interleaved Burst Address Table
(MODE = Floating or V_{DD})**

First Address A1: A0	Second Address A1: A0	Third Address A1: A0	Fourth Address A1: A0
00	01	10	11
01	00	11	10
10	11	00	01
11	10	01	00

**Linear Burst Address Table
(MODE = GND)**

First Address A1: A0	Second Address A1: A0	Third Address A1: A0	Fourth Address A1: A0
00	01	10	11
01	10	11	00
10	11	00	01
11	00	01	10

ZZ Mode Electrical Characteristics

Parameter	Description	Test Conditions	Min.	Max.	Unit
I _{DDZZ}	Sleep mode standby current	ZZ ≥ V _{DD} - 0.2V		35	mA
t _{ZZS}	Device operation to ZZ	ZZ ≥ V _{DD} - 0.2V		2t _{CYC}	ns
t _{ZZREC}	ZZ recovery time	ZZ ≤ 0.2V	2t _{CYC}		ns
t _{ZZI}	ZZ active to sleep current	This parameter is sampled		2t _{CYC}	ns
t _{RZZI}	ZZ Inactive to exit sleep current	This parameter is sampled	0		ns



Truth Table^[2, 3, 4, 5, 6, 7, 8]

Operation	Address Used	\overline{CE}_1	CE_2	\overline{CE}_3	ZZ	ADV/LD	\overline{WE}	\overline{BW}_x	\overline{OE}	\overline{CEN}	CLK	DQ
Deselect Cycle	None	H	X	X	L	L	X	X	X	L	L->H	Three-State
Deselect Cycle	None	X	X	H	L	L	X	X	X	L	L->H	Three-State
Deselect Cycle	None	X	L	X	L	L	X	X	X	L	L->H	Three-State
Continue Deselect Cycle	None	X	X	X	L	H	X	X	X	L	L->H	Three-State
READ Cycle (Begin Burst)	External	L	H	L	L	L	H	X	L	L	L->H	Data Out (Q)
READ Cycle (Continue Burst)	Next	X	X	X	L	H	X	X	L	L	L->H	Data Out (Q)
NOP/DUMMY READ (Begin Burst)	External	L	H	L	L	L	H	X	H	L	L->H	Three-State
DUMMY READ (Continue Burst)	Next	X	X	X	L	H	X	X	H	L	L->H	Three-State
WRITE Cycle (Begin Burst)	External	L	H	L	L	L	L	L	X	L	L->H	Data In (D)
WRITE Cycle (Continue Burst)	Next	X	X	X	L	H	X	L	X	L	L->H	Data In (D)
NOP/WRITE ABORT (Begin Burst)	None	L	H	L	L	L	L	H	X	L	L->H	Three-State
WRITE ABORT (Continue Burst)	Next	X	X	X	L	H	X	H	X	L	L->H	Three-State
IGNORE CLOCK EDGE (Stall)	Current	X	X	X	L	X	X	X	X	H	L->H	-
SLEEP MODE	None	X	X	X	H	X	X	X	X	X	X	Three-State

Notes:

- X = "Don't Care." H = Logic HIGH, L = Logic LOW. $\overline{BW}_x = L$ signifies at least one Byte Write Select is active, $\overline{BW}_x = Valid$ signifies that the desired Byte Write Selects are asserted, see Truth Table for details.
- Write is defined by \overline{BW}_x , and \overline{WE} . See Truth Table for Read/Write.
- When a Write cycle is detected, all I/Os are three-stated, even during Byte Writes.
- The DQs and DQP_x pins are controlled by the current cycle and the \overline{OE} signal. \overline{OE} is asynchronous and is not sampled with the clock.
- $\overline{CEN} = H$, inserts wait states.
- Device will power-up deselected and the I/Os in a three-state condition, regardless of \overline{OE} .
- \overline{OE} is asynchronous and is not sampled with the clock rise. It is masked internally during Write cycles. During a Read cycle DQs and $DQP_x = Three-state$ when \overline{OE} is inactive or when the device is deselected, and DQs and $DQP_x = data$ when \overline{OE} is active.
- Table only lists a partial listing of the byte write combinations. Any combination of \overline{BW}_x is valid. Appropriate write will be done based on which byte write is active.



Partial Truth Table for Read/Write^[2, 3, 9]

Function (CY7C1355C)	\overline{WE}	\overline{BW}_A	\overline{BW}_B	\overline{BW}_C	\overline{BW}_D
Read	H	X	X	X	X
Write No bytes written	L	H	H	H	H
Write Byte A – (DQ _A and DQP _A)	L	L	H	H	H
Write Byte B – (DQ _B and DQP _B)	L	H	L	H	H
Write Byte C – (DQ _C and DQP _C)	L	H	H	L	H
Write Byte D – (DQ _D and DQP _D)	L	H	H	H	L
Write All Bytes	L	L	L	L	L

Truth Table for Read/Write^[2, 3, 9]

Function (CY7C1357C)	\overline{WE}	\overline{BW}_A	\overline{BW}_B
Read	H	X	X
Write - No bytes written	L	H	H
Write Byte A – (DQ _A and DQP _A)	L	H	H
Write Byte B – (DQ _B and DQP _B)	L	H	H
Write All Bytes	L	L	L

IEEE 1149.1 Serial Boundary Scan (JTAG)

The CY7C1355C/CY7C1357C incorporates a serial boundary scan test access port (TAP). This part is fully compliant with 1149.1. The TAP operates using JEDEC-standard 3.3V or 2.5V I/O logic levels.

The CY7C1355C/CY7C1357C contains a TAP controller, instruction register, boundary scan register, bypass register, and ID register.

Disabling the JTAG Feature

It is possible to operate the SRAM without using the JTAG feature. To disable the TAP controller, TCK must be tied LOW(Vss) to prevent clocking of the device. TDI and TMS are internally pulled up and may be unconnected. They may alternately be connected to VDD through a pull-up resistor. TDO should be left unconnected. Upon power-up, the device will come up in a reset state which will not interfere with the operation of the device.

TAP Controller State Diagram

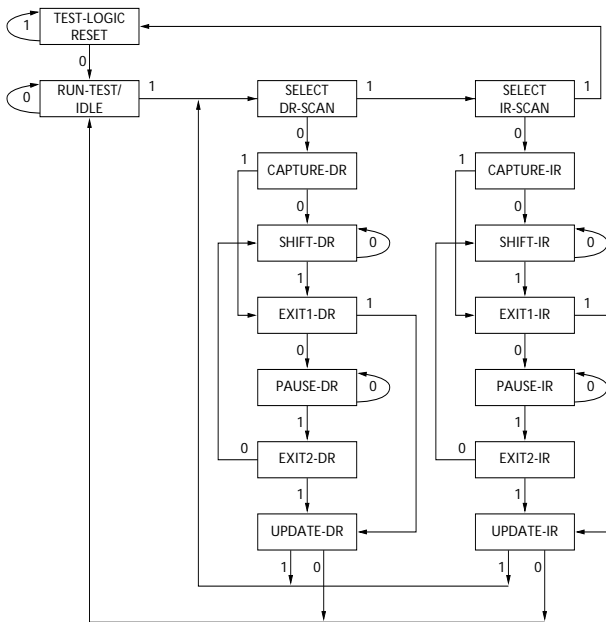

The 0/1 next to each state represents the value of TMS at the rising edge of the TCK.

Test Access Port (TAP)

Test Clock (TCK)

The test clock is used only with the TAP controller. All inputs are captured on the rising edge of TCK. All outputs are driven from the falling edge of TCK.

Test MODE SELECT (TMS)

The TMS input is used to give commands to the TAP controller and is sampled on the rising edge of TCK. It is allowable to leave this ball unconnected if the TAP is not used. The ball is pulled up internally, resulting in a logic HIGH level.

Test Data-In (TDI)

The TDI ball is used to serially input information into the registers and can be connected to the input of any of the registers. The register between TDI and TDO is chosen by the instruction that is loaded into the TAP instruction register. For information on loading the instruction register, see Figure . TDI is internally pulled up and can be unconnected if the TAP is unused in an application. TDI is connected to the most significant bit (MSB) of any register. (See Tap Controller Block Diagram.)

Test Data-Out (TDO)

The TDO output ball is used to serially clock data-out from the registers. The output is active depending upon the current state of the TAP state machine. The output changes on the falling edge of TCK. TDO is connected to the least significant bit (LSB) of any register. (See Tap Controller State Diagram.)

TAP Controller Block Diagram

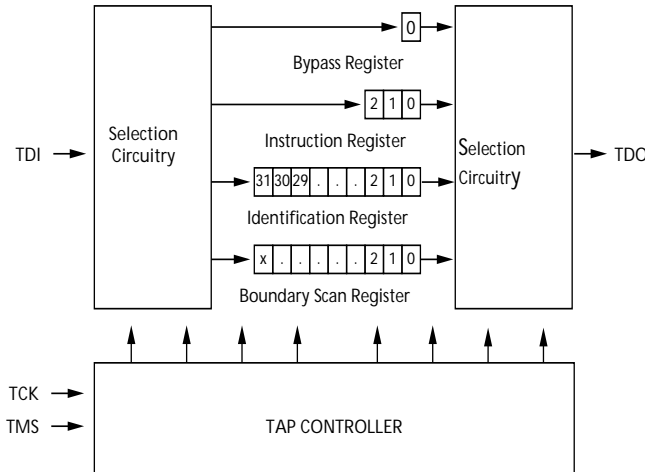

Performing a TAP Reset

A RESET is performed by forcing TMS HIGH (VDD) for five rising edges of TCK. This RESET does not affect the operation of the SRAM and may be performed while the SRAM is operating.

At power-up, the TAP is reset internally to ensure that TDO comes up in a High-Z state.

TAP Registers

Registers are connected between the TDI and TDO balls and allow data to be scanned into and out of the SRAM test circuitry. Only one register can be selected at a time through the instruction register. Data is serially loaded into the TDI ball on the rising edge of TCK. Data is output on the TDO ball on the falling edge of TCK.

Instruction Register

Three-bit instructions can be serially loaded into the instruction register. This register is loaded when it is placed between the TDI and TDO balls as shown in the Tap Controller Block Diagram. Upon power-up, the instruction register is loaded with the IDCODE instruction. It is also loaded with the IDCODE instruction if the controller is placed in a reset state as described in the previous section.

When the TAP controller is in the Capture-IR state, the two least significant bits are loaded with a binary "01" pattern to allow for fault isolation of the board-level serial test data path.

Bypass Register

To save time when serially shifting data through registers, it is sometimes advantageous to skip certain chips. The bypass register is a single-bit register that can be placed between the TDI and TDO balls. This allows data to be shifted through the SRAM with minimal delay. The bypass register is set LOW (Vss) when the BYPASS instruction is executed.

Boundary Scan Register

The boundary scan register is connected to all the input and bidirectional balls on the SRAM.

The boundary scan register is loaded with the contents of the RAM I/O ring when the TAP controller is in the Capture-DR state and is then placed between the TDI and TDO balls when the controller is moved to the Shift-DR state. The EXTTEST, SAMPLE/PRELOAD and SAMPLE Z instructions can be used to capture the contents of the I/O ring.

The Boundary Scan Order tables show the order in which the bits are connected. Each bit corresponds to one of the bumps on the SRAM package. The MSB of the register is connected to TDI, and the LSB is connected to TDO.

Identification (ID) Register

The ID register is loaded with a vendor-specific, 32-bit code during the Capture-DR state when the IDCODE command is loaded in the instruction register. The IDCODE is hardwired into the SRAM and can be shifted out when the TAP controller is in the Shift-DR state. The ID register has a vendor code and other information described in the Identification Register Definitions table.

TAP Instruction Set

Overview

Eight different instructions are possible with the three bit instruction register. All combinations are listed in the Instruction Codes table. Three of these instructions are listed as RESERVED and should not be used. The other five instructions are described in detail below.

Instructions are loaded into the TAP controller during the Shift-IR state when the instruction register is placed between TDI and TDO. During this state, instructions are shifted through the instruction register through the TDI and TDO balls. To execute the instruction once it is shifted in, the TAP controller needs to be moved into the Update-IR state.

IDCODE

The IDCODE instruction causes a vendor-specific, 32-bit code to be loaded into the instruction register. It also places the instruction register between the TDI and TDO balls and allows the IDCODE to be shifted out of the device when the TAP controller enters the Shift-DR state.

The IDCODE instruction is loaded into the instruction register upon power-up or whenever the TAP controller is given a test logic reset state.

SAMPLE Z

The SAMPLE Z instruction causes the boundary scan register to be connected between the TDI and TDO pins when the TAP controller is in a Shift-DR state. The SAMPLE Z command puts the output bus into a High-Z state until the next command is given during the "Update IR" state.

SAMPLE/PRELOAD

SAMPLE / PRELOAD is a 1149.1 mandatory instruction. When the SAMPLE / PRELOAD instructions are loaded into the instruction register and the TAP controller is in the Capture-DR state, a snapshot of data on the inputs and output pins is captured in the boundary scan register.

The user must be aware that the TAP controller clock can only operate at a frequency up to 20 MHz, while the SRAM clock operates more than an order of magnitude faster. Because there is a large difference in the clock frequencies, it is possible that during the Capture-DR state, an input or output will undergo a transition. The TAP may then try to capture a signal while in transition (metastable state). This will not harm the device, but there is no guarantee as to the value that will be captured. Repeatable results may not be possible.

To guarantee that the boundary scan register will capture the correct value of a signal, the SRAM signal must be stabilized long enough to meet the TAP controller's capture set-up plus hold times (t_{CS} and t_{CH}). The SRAM clock input might not be captured correctly if there is no way in a design to stop (or slow) the clock during a SAMPLE / PRELOAD instruction. If this is an issue, it is still possible to capture all other signals and simply ignore the value of the CK and CK# captured in the boundary scan register.

Once the data is captured, it is possible to shift out the data by putting the TAP into the Shift-DR state. This places the boundary scan register between the TDI and TDO pins.

PRELOAD allows an initial data pattern to be placed at the latched parallel outputs of the boundary scan register cells prior to the selection of another boundary scan test operation.

The shifting of data for the SAMPLE and PRELOAD phases can occur concurrently when required - that is, while data captured is shifted out, the preloaded data can be shifted in.

BYPASS

When the BYPASS instruction is loaded in the instruction register and the TAP is placed in a Shift-DR state, the bypass register is placed between the TDI and TDO pins. The advantage of the BYPASS instruction is that it shortens the boundary scan path when multiple devices are connected together on a board.

EXTEST

The EXTEST instruction enables the preloaded data to be driven out through the system output pins. This instruction also selects the boundary scan register to be connected for serial access between the TDI and TDO in the shift-DR controller state.

EXTEST OUTPUT BUS TRI-STATE

IEEE Standard 1149.1 mandates that the TAP controller be able to put the output bus into a tri-state mode.

The boundary scan register has a special bit located at bit #85 (for 119-BGA package), bit #89 (for 165-FBGA package). When this scan cell, called the "extest output bus tristate", is latched into the preload register during the "Update-DR" state in the TAP controller, it will directly control the state of the output (Q-bus) pins, when the EXTEST is entered as the current instruction. When HIGH, it will enable the output buffers to drive the output bus. When LOW, this bit will place the output bus into a High-Z condition.

This bit can be set by entering the SAMPLE/PRELOAD or EXTEST command, and then shifting the desired bit into that cell, during the "Shift-DR" state. During "Update-DR", the value loaded into that shift-register cell will latch into the preload register. When the EXTEST instruction is entered, this bit will directly control the output Q-bus pins. Note that this bit is pre-set HIGH to enable the output when the device is powered-up, and also when the TAP controller is in the "Test-Logic-Reset" state.

Reserved

These instructions are not implemented but are reserved for future use. Do not use these instructions.

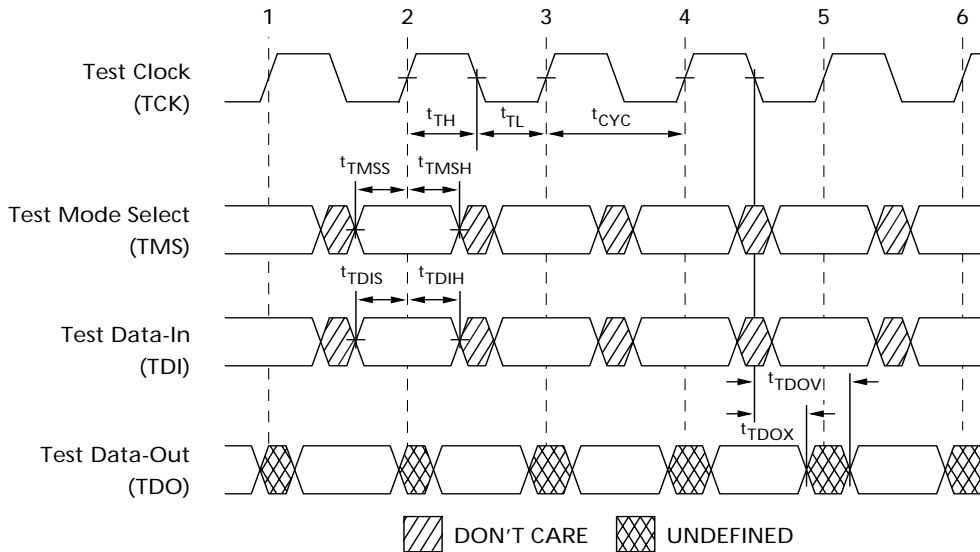
TAP Timing

TAP AC Switching Characteristics Over the operating Range^[10, 11]

Parameter	Description	Min.	Max.	Unit
Clock				
t_{TCYC}	TCK Clock Cycle Time	50		ns
t_{TF}	TCK Clock Frequency		20	MHz
t_{TH}	TCK Clock HIGH time	25		ns
t_{TL}	TCK Clock LOW time	25		ns
Output Times				
t_{TDOV}	TCK Clock LOW to TDO Valid		5	ns
t_{TDOX}	TCK Clock LOW to TDO Invalid	0		ns
Set-up Times				
t_{TMSS}	TMS Set-Up to TCK Clock Rise	5		ns
t_{TDIS}	TDI Set-Up to TCK Clock Rise	5		ns
t_{CS}	Capture Set-Up to TCK Rise	5		
Hold Times				
t_{TMSH}	TMS hold after TCK Clock Rise	5		ns
t_{TDIH}	TDI Hold after Clock Rise	5		ns
t_{CH}	Capture Hold after Clock Rise	5		ns

Notes:

10. t_{CS} and t_{CH} refer to the set-up and hold time requirements of latching data from the boundary scan register.
 11. Test conditions are specified using the load in TAP AC Test Conditions. $t_R/t_F = 1$ ns.

3.3V TAP AC Test Conditions

Input pulse levels V_{SS} to 3.3V
 Input rise and fall times 1 ns
 Input timing reference levels 1.5V
 Output reference levels 1.5V
 Test load termination supply voltage 1.5V

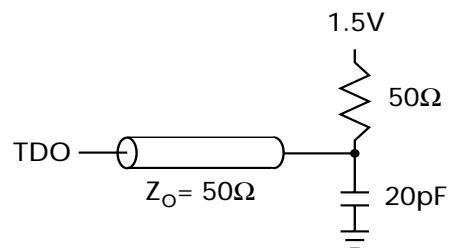
3.3V TAP AC Output Load Equivalent

2.5V TAP AC Test Conditions

Input pulse levels V_{SS} to 2.5V
 Input rise and fall time 1 ns
 Input timing reference levels 1.25V
 Output reference levels 1.25V
 Test load termination supply voltage 1.25V

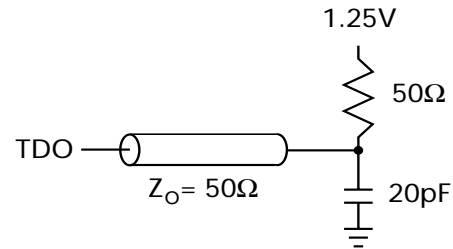
2.5V TAP AC Output Load Equivalent

TAP DC Electrical Characteristics And Operating Conditions

($0^{\circ}\text{C} < T_A < +70^{\circ}\text{C}$; $V_{DD} = 3.3\text{V} \pm 0.165\text{V}$ unless otherwise noted)^[12]

Parameter	Description	Conditions		Min.	Max.	Unit
V_{OH1}	Output HIGH Voltage	$I_{OH} = -4.0\text{ mA}$	$V_{DDQ} = 3.3\text{V}$	2.4		V
		$I_{OH} = -1.0\text{ mA}$	$V_{DDQ} = 2.5\text{V}$	2.0		V
V_{OH2}	Output HIGH Voltage	$I_{OH} = -100\text{ }\mu\text{A}$	$V_{DDQ} = 3.3\text{V}$	2.9		V
			$V_{DDQ} = 2.5\text{V}$	2.1		V
V_{OL1}	Output LOW Voltage	$I_{OL} = 8.0\text{ mA}$	$V_{DDQ} = 3.3\text{V}$		0.4	V
			$V_{DDQ} = 2.5\text{V}$		0.4	V
V_{OL2}	Output LOW Voltage	$I_{OL} = 100\text{ }\mu\text{A}$	$V_{DDQ} = 3.3\text{V}$		0.2	V
			$V_{DDQ} = 2.5\text{V}$		0.2	V
V_{IH}	Input HIGH Voltage		$V_{DDQ} = 3.3\text{V}$	2.0	$V_{DD} + 0.3$	V
			$V_{DDQ} = 2.5\text{V}$	1.7	$V_{DD} + 0.3$	V
V_{IL}	Input LOW Voltage		$V_{DDQ} = 3.3\text{V}$	-0.5	0.7	V
			$V_{DDQ} = 2.5\text{V}$	-0.3	0.7	V
I_X	Input Load Current	$\text{GND} \leq V_{IN} \leq V_{DDQ}$		-5	5	μA

Note:

12. All voltages referenced to V_{SS} (GND).

Identification Register Definitions

Instruction Field	CY7C1355C (256Kx36)	CY7C1357C (512Kx18)	Description
Revision Number (31:29)	010	010	Describes the version number
Device Depth (28:24)	01010	01010	Reserved for Internal Use
Device Width (23:18)	001001	001001	Defines memory type and architecture
Cypress Device ID (17:12)	100110	010110	Defines width and density
Cypress JEDEC ID Code (11:1)	00000110100	00000110100	Allows unique identification of SRAM vendor
ID Register Presence Indicator (0)	1	1	Indicates the presence of an ID register

Scan Register Sizes

Register Name	Bit Size (x36)	Bit Size (x18)
Instruction	3	3
Bypass	1	1
ID	32	32
Boundary Scan Order (119-ball BGA package)	85	85
Boundary Scan Order (165-ball fBGA package)	89	89

Identification Codes

Instruction	Code	Description
EXTEST	000	Captures I/O ring contents. Places the boundary scan register between TDI and TDO. Forces all SRAM outputs to High-Z state. This instruction is not 1149.1 compliant.
IDCODE	001	Loads the ID register with the vendor ID code and places the register between TDI and TDO. This operation does not affect SRAM operations.
SAMPLE Z	010	Captures I/O ring contents. Places the boundary scan register between TDI and TDO. Forces all SRAM output drivers to a High-Z state.
RESERVED	011	Do Not Use: This instruction is reserved for future use.
SAMPLE/PRELOAD	100	Captures I/O ring contents. Places the boundary scan register between TDI and TDO. Does not affect SRAM operation. This instruction does not implement 1149.1 preload function and is therefore not 1149.1 compliant.
RESERVED	101	Do Not Use: This instruction is reserved for future use.
RESERVED	110	Do Not Use: This instruction is reserved for future use.
BYPASS	111	Places the bypass register between TDI and TDO. This operation does not affect SRAM operations.



119-ball BGA Boundary Scan Order^[13, 14]

CY7C1355C (256K x 36)			
BIT #	BALL ID	BIT #	BALL ID
1	H4	37	B6
2	T4	38	D4
3	T5	39	B4
4	T6	40	F4
5	R5	41	M4
6	L5	42	A5
7	R6	43	K4
8	U6	44	E4
9	R7	45	G4
10	T7	46	A4
11	P6	47	G3
12	N7	48	C3
13	M6	49	B2
14	L7	50	B3
15	K6	51	A3
16	P7	52	C2
17	N6	53	A2
18	L6	54	B1
19	K7	55	C1
20	J5	56	D2
21	H6	57	E1
22	G7	58	F2
23	F6	59	G1
24	E7	60	H2
25	D7	61	D1
26	H7	62	E2
27	G6	63	G2
28	E6	64	H1
29	D6	65	J3
30	C7	66	2K
31	B7	67	L1
32	C6	68	M2
33	A6	69	N1
34	C5	70	P1
35	B5	71	K1
36	G5	72	L2

CY7C1355C (256K x 36)	
BIT#	BALL ID
73	N2
74	P2
75	R3
76	T1
77	R1
78	T2
79	L3
80	R2
81	T3
82	L4
83	N4
84	P4
85	Internal

Note:

- 13. Balls which are NC (No Connect) are Pre-Set LOW
- 14. Bit# 85 is Pre-Set HIGH



119-ball BGA Boundary Scan Order [13, 14]

CY7C1357C (512K x 18)			
BIT#	BALL ID	BIT#	BALL ID
1	H4	37	B6
2	T4	38	D4
3	T5	39	B4
4	T6	40	F4
5	R5	41	M4
6	L5	42	A5
7	R6	43	K4
8	U6	44	E4
9	R7	45	G4
10	T7	46	A4
11	P6	47	G3
12	N7	48	C3
13	M6	49	B2
14	L7	50	B3
15	K6	51	A3
16	P7	52	C2
17	N6	53	A2
18	L6	54	B1
19	K7	55	C1
20	J5	56	D2
21	H6	57	E1
22	G7	58	F2
23	F6	59	G1
24	E7	60	H2
25	D7	61	D1
26	H7	62	E2
27	G6	63	G2
28	E6	64	H1
29	D6	65	J3
30	C7	66	2K
31	B7	67	L1
32	C6	68	M2
33	A6	69	N1
34	C5	70	P1
35	B5	71	K1
36	G5	72	L2

CY7C1357C (512K x 18)	
BIT#	BALL ID
73	N2
74	P2
75	R3
76	T1
77	R1
78	T2
79	L3
80	R2
81	T3
82	L4
83	N4
84	P4
85	Internal



165-Ball fBGA Boundary Scan Order [13, 15]

CY7C1355C (256K x 36)			
BIT#	BALL ID	BIT#	BALL ID
1	N6	37	A9
2	N7	38	B9
3	10N	39	C10
4	P11	40	A8
5	P8	41	B8
6	R8	42	A7
7	R9	43	B7
8	P9	44	B6
9	P10	45	A6
10	R10	46	B5
11	R11	47	A5
12	H11	48	A4
13	N11	49	B4
14	M11	50	B3
15	L11	51	A3
16	K11	52	A2
17	J11	53	B2
18	M10	54	C2
19	L10	55	B1
20	K10	56	A1
21	J10	57	C1
22	H9	58	D1
23	H10	59	E1
24	G11	60	F1
25	F11	61	G1
26	E11	62	D2
27	D11	63	E2
28	G10	64	F2
29	F10	65	G2
30	E10	66	H1
31	D10	67	H3
32	C11	68	J1
33	A11	69	K1
34	B11	70	L1
35	A10	71	M1
36	B10	72	J2

CY7C1355C (256K x 36)	
BIT#	BALL ID
73	K2
74	L2
75	M2
76	N1
77	N2
78	P1
79	R1
80	R2
81	P3
82	R3
83	P2
84	R4
85	P4
86	N5
87	P6
88	R6
89	Internal

Note:
15. Bit# 89 is Pre-Set HIGH



165-Ball fBGA Boundary Scan Order [13, 15]

CY7C1357C (512K x 18)			
BIT#	BALL ID	BIT#	BALL ID
1	N6	37	A9
2	N7	38	B9
3	10N	39	C10
4	P11	40	A8
5	P8	41	B8
6	R8	42	A7
7	R9	43	B7
8	P9	44	B6
9	P10	45	A6
10	R10	46	B5
11	R11	47	A5
12	H11	48	A4
13	N11	49	B4
14	M11	50	B3
15	L11	51	A3
16	K11	52	A2
17	J11	53	B2
18	M10	54	C2
19	L10	55	B1
20	K10	56	A1
21	J10	57	C1
22	H9	58	D1
23	H10	59	E1
24	G11	60	F1
25	F11	61	G1
26	E11	62	D2
27	D11	63	E2
28	G10	64	F2
29	F10	65	G2
30	E10	66	H1
31	D10	67	H3
32	C11	68	J1
33	A11	69	K1
34	B11	70	L1
35	A10	71	M1
36	B10	72	J2

CY7C1357C (512K x 18)	
BIT#	BALL ID
73	K2
74	L2
75	M2
76	N1
77	N2
78	P1
79	R1
80	R2
81	P3
82	R3
83	P2
84	R4
85	P4
86	N5
87	P6
88	R6
89	Internal

Note:
16. Bit# 89 is Pre-Set HIGH



Maximum Ratings

(Above which the useful life may be impaired. For user guidelines, not tested.)

- Storage Temperature -65°C to +150°C
- Ambient Temperature with Power Applied..... -55°C to +125°C
- Supply Voltage on V_{DD} Relative to GND..... -0.5V to +4.6V
- DC Voltage Applied to Outputs in Three-State -0.5V to V_{DDQ} + 0.5V
- DC Input Voltage..... -0.5V to V_{DD} + 0.5V

- Current into Outputs (LOW)..... 20 mA
- Static Discharge Voltage..... >2001V (per MIL-STD-883, Method 3015)
- Latch-up Current..... >200 mA

Operating Range

Range	Ambient Temperature	V _{DD}	V _{DDQ}
Commercial	0°C to +70°C	3.3V – 5%/+10%	2.5V – 5% to V _{DD}
Industrial	-40°C to +85°C		

Electrical Characteristics Over the Operating Range^[17, 18]

Parameter	Description	Test Conditions	Min.	Max.	Unit
V _{DD}	Power Supply Voltage		3.135	3.6	V
V _{DDQ}	I/O Supply Voltage	V _{DDQ} = 3.3V	3.135	V _{DD}	V
		V _{DDQ} = 2.5V	2.375	2.625	
V _{OH}	Output HIGH Voltage	V _{DDQ} = 3.3V, V _{DD} = Min., I _{OH} = -4.0 mA	2.4		V
		V _{DDQ} = 2.5V, V _{DD} = Min., I _{OH} = -1.0 mA	2.0		V
V _{OL}	Output LOW Voltage	V _{DDQ} = 3.3V, V _{DD} = Min., I _{OL} = 8.0 mA		0.4	V
		V _{DDQ} = 2.5V, V _{DD} = Min., I _{OL} = 1.0 mA		0.4	V
V _{IH}	Input HIGH Voltage ^[17]	V _{DDQ} = 3.3V	2.0	V _{DD} + 0.3V	V
		V _{DDQ} = 2.5V	1.7	V _{DD} + 0.3V	V
V _{IL}	Input LOW Voltage ^[17]	V _{DDQ} = 3.3V	-0.3	0.8	V
		V _{DDQ} = 2.5V	-0.3	0.7	V
I _X	Input Load	GND ≤ V _I ≤ V _{DDQ}	-5	5	μA
	Input Current of MODE	Input = V _{SS}	-30		μA
		Input = V _{DD}		5	μA
	Input Current of ZZ	Input = V _{SS}	-5		μA
Input = V _{DD}			30	μA	
I _{OZ}	Output Leakage Current	GND ≤ V _I ≤ V _{DD} , Output Disabled	-5	5	μA
I _{DD}	V _{DD} Operating Supply Current	V _{DD} = Max., I _{OUT} = 0 mA, f = f _{MAX} = 1/t _{CYC}	7.5-ns cycle, 133 MHz	250	mA
			8.5-ns cycle, 117 MHz	220	mA
			10-ns cycle, 100 MHz	180	
I _{SB1}	Automatic CE Power-down Current—TTL Inputs	V _{DD} = Max, Device Deselected, V _{IN} ≥ V _{IH} or V _{IN} ≤ V _{IL} , f = f _{MAX} , inputs switching		40	mA
I _{SB2}	Automatic CE Power-down Current—CMOS Inputs	V _{DD} = Max, Device Deselected, V _{IN} ≤ 0.3V or V _{IN} ≥ V _{DD} - 0.3V, f = 0, inputs static		30	mA
I _{SB3}	Automatic CE Power-down Current—CMOS Inputs	V _{DD} = Max, Device Deselected, or V _{IN} ≤ 0.3V or V _{IN} ≥ V _{DDQ} - 0.3V, f = f _{MAX} , inputs switching		40	mA
I _{SB4}	Automatic CE Power-down Current—TTL Inputs	V _{DD} = Max, Device Deselected, V _{IN} ≥ V _{DD} - 0.3V or V _{IN} ≤ 0.3V, f = 0, inputs static		40	mA

Notes:

- 17. Overshoot: V_{IH}(AC) < V_{DD} + 1.5V (Pulse width less than t_{CYC}/2), undershoot: V_{IL}(AC) > -2V (Pulse width less than t_{CYC}/2).
- 18. T_{Power-up}: Assumes a linear ramp from 0V to V_{DD}(min.) within 200 ms. During this time V_{IH} ≤ V_{DD} and V_{DDQ} ≤ V_{DD}.

Thermal Resistance^[19]

Parameter	Description	Test Conditions	TQFP Package	BGA Package	fBGA Package	Unit
Θ_{JA}	Thermal Resistance (Junction to Ambient)	Test conditions follow standard test methods and procedures for measuring thermal impedance, per EIA / JESD51.	25	25	27	°C/W
Θ_{JC}	Thermal Resistance (Junction to Case)		9	6	6	°C/W

Capacitance^[19]

Parameter	Description	Test Conditions	TQFP Package	BGA Package	fBGA Package	Unit
C_{IN}	Input Capacitance	$T_A = 25^\circ\text{C}$, $f = 1\text{ MHz}$, $V_{DD} = 3.3\text{V}$, $V_{DDQ} = 2.5\text{V}$	5	5	5	pF
C_{CLK}	Clock Input Capacitance		5	5	5	pF
$C_{I/O}$	Input/Output Capacitance		5	7	7	pF

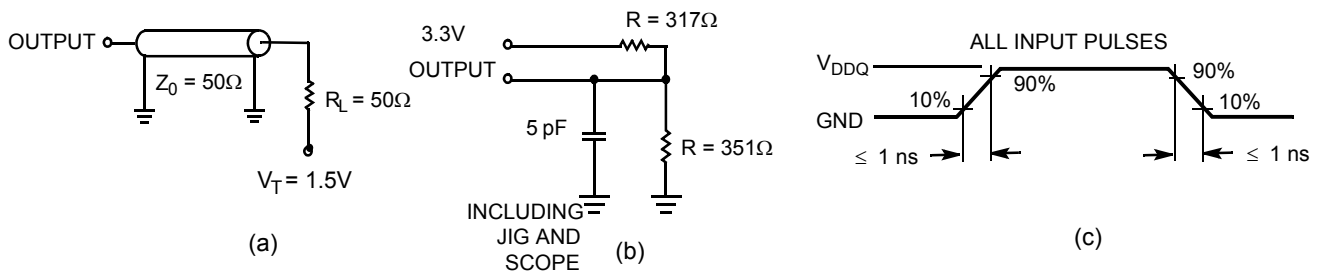
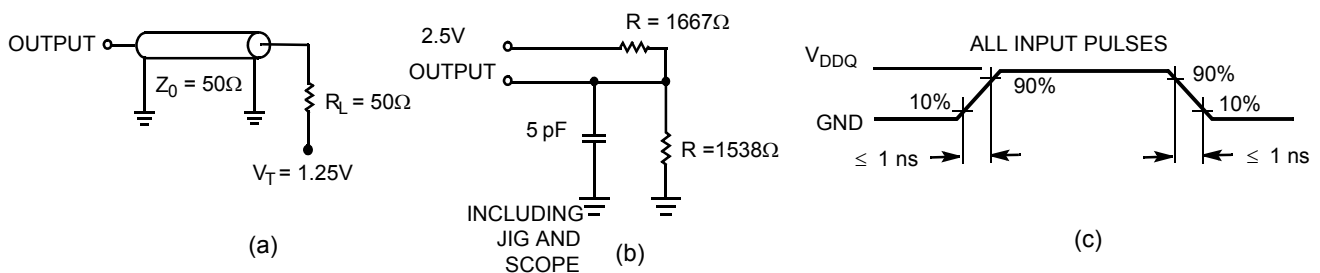
AC Test Loads and Waveforms
3.3V I/O Test Load

2.5V I/O Test Load

Notes:

19. Tested initially and after any design or process change that may affect these parameters.



Switching Characteristics Over the Operating Range^[20, 21, 22, 23, 24, 25]

Parameter	Description	133 MHz		117 MHz		100 MHz		Unit
		Min.	Max.	Min.	Max.	Min.	Max.	
t _{POWER}	V _{DD} (Typical) to the First Access ^[22]	1		1		1		ms
Clock								
t _{CYC}	Clock Cycle Time	7.5		8.5		10		ns
t _{CH}	Clock HIGH	3.0		3.2		4.0		ns
t _{CL}	Clock LOW	3.0		3.2		4.0		ns
Output Times								
t _{CDV}	Data Output Valid after CLK Rise		6.5		7.0		7.5	ns
t _{DOH}	Data Output Hold after CLK Rise	2.0		2.0		2.0		ns
t _{CLZ}	Clock to Low-Z ^[23, 24, 25]	0		0		0		ns
t _{CHZ}	Clock to High-Z ^[23, 24, 25]		3.5		3.5		3.5	ns
t _{OEV}	\overline{OE} LOW to Output Valid		3.5		3.5		3.5	ns
t _{OELZ}	\overline{OE} LOW to Output Low-Z ^[23, 24, 25]	0		0		0		ns
t _{OEHZ}	\overline{OE} HIGH to Output High-Z ^[23, 24, 25]		3.5		3.5		3.5	ns
Set-up Times								
t _{AS}	Address Set-up before CLK Rise	1.5		1.5		1.5		ns
t _{ALS}	ADV/LD Set-up before CLK Rise	1.5		1.5		1.5		ns
t _{WES}	\overline{WE} , \overline{BW}_X Set-up before CLK Rise	1.5		1.5		1.5		ns
t _{CENS}	\overline{CEN} Set-up before CLK Rise	1.5		1.5		1.5		ns
t _{DS}	Data Input Set-up before CLK Rise	1.5		1.5		1.5		ns
t _{CES}	Chip Enable Set-Up before CLK Rise	1.5		1.5		1.5		ns
Hold Times								
t _{AH}	Address Hold after CLK Rise	0.5		0.5		0.5		ns
t _{ALH}	ADV/LD Hold after CLK Rise	0.5		0.5		0.5		ns
t _{WEH}	\overline{WE} , \overline{BW}_X Hold after CLK Rise	0.5		0.5		0.5		ns
t _{CENH}	\overline{CEN} Hold after CLK Rise	0.5		0.5		0.5		ns
t _{DH}	Data Input Hold after CLK Rise	0.5		0.5		0.5		ns
t _{CEH}	Chip Enable Hold after CLK Rise	0.5		0.5		0.5		ns

Notes:

- 20. Timing reference level is 1.5V when V_{DDQ} = 3.3V and is 1.25V when V_{DDQ} = 2.5V.
- 21. Test conditions shown in (a) of AC Test Loads unless otherwise noted.
- 22. This part has a voltage regulator internally; t_{POWER} is the time that the power needs to be supplied above V_{DD}(minimum) initially, before a Read or Write operation can be initiated.
- 23. t_{CHZ}, t_{CLZ}, t_{OELZ}, and t_{OEHZ} are specified with AC test conditions shown in part (b) of AC Test Loads. Transition is measured ± 200 mV from steady-state voltage.
- 24. At any given voltage and temperature, t_{OEHZ} is less than t_{OELZ} and t_{CHZ} is less than t_{CLZ} to eliminate bus contention between SRAMs when sharing the same data bus. These specifications do not imply a bus contention condition, but reflect parameters guaranteed over worst case user conditions. Device is designed to achieve High-Z prior to Low-Z under the same system conditions
- 25. This parameter is sampled and not 100% tested.

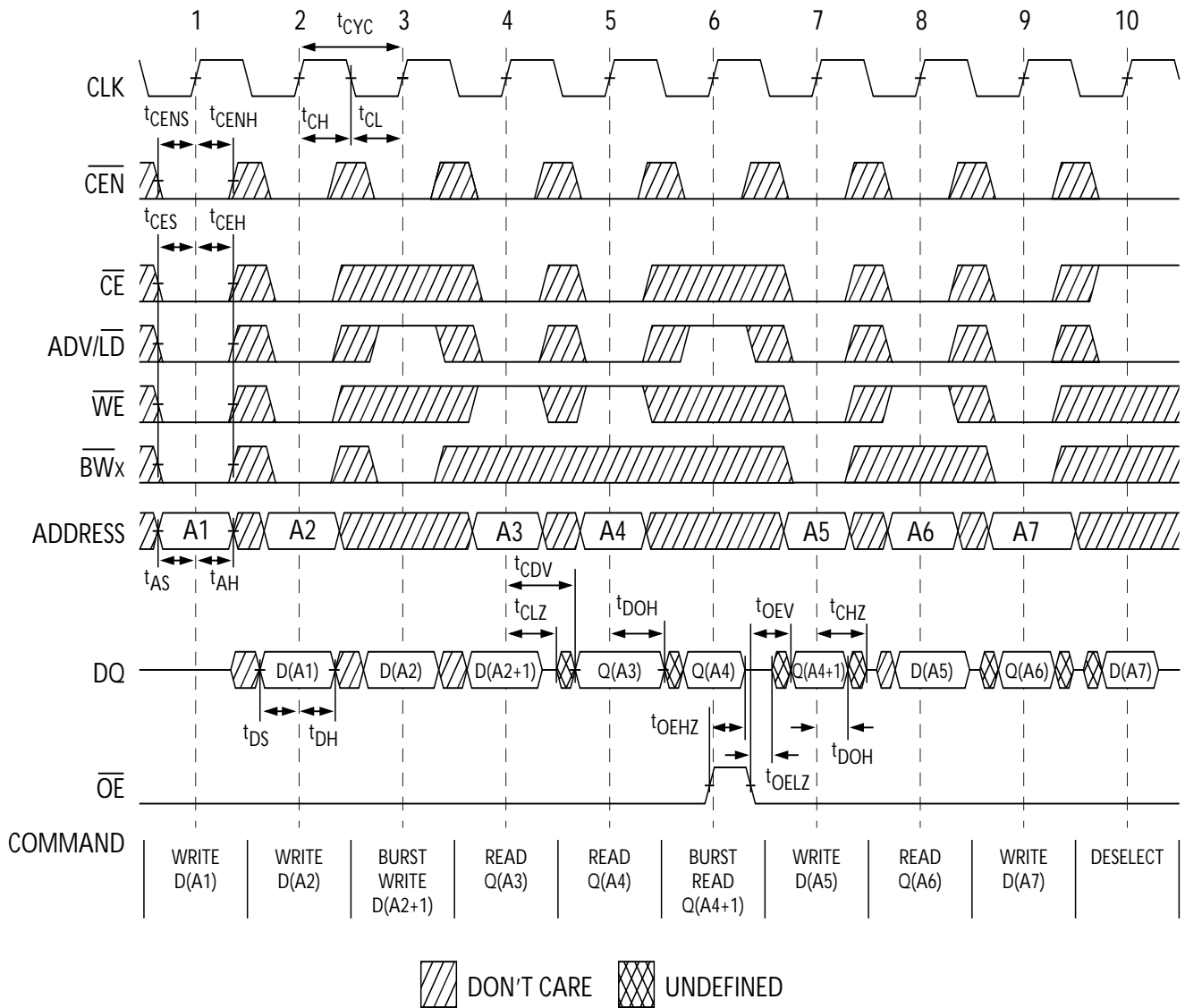
Switching Waveforms
Read/Write Waveforms^[26, 27, 28]

Notes:

26. For this waveform ZZ is tied LOW.

27. When \overline{CE} is LOW, \overline{CE}_1 is LOW, \overline{CE}_2 is HIGH and \overline{CE}_3 is LOW. When \overline{CE} is HIGH, \overline{CE}_1 is HIGH or \overline{CE}_2 is LOW or \overline{CE}_3 is HIGH.

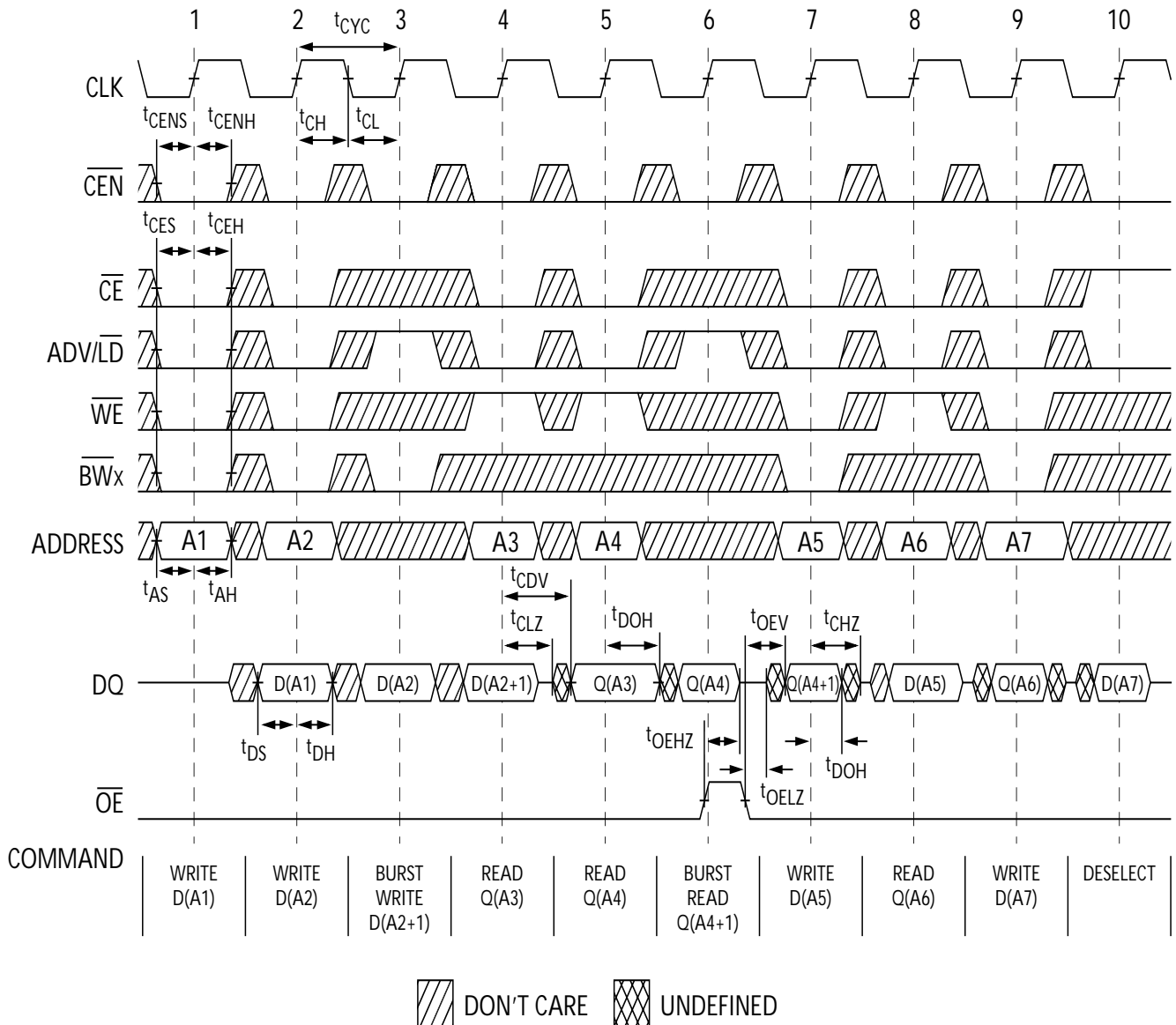
28. Order of the Burst sequence is determined by the status of the MODE (0 = Linear, 1 = Interleaved). Burst operations are optional.

Switching Waveforms (continued)
NOP, STALL AND DESELECT Cycles^[26, 27, 29]

Note:

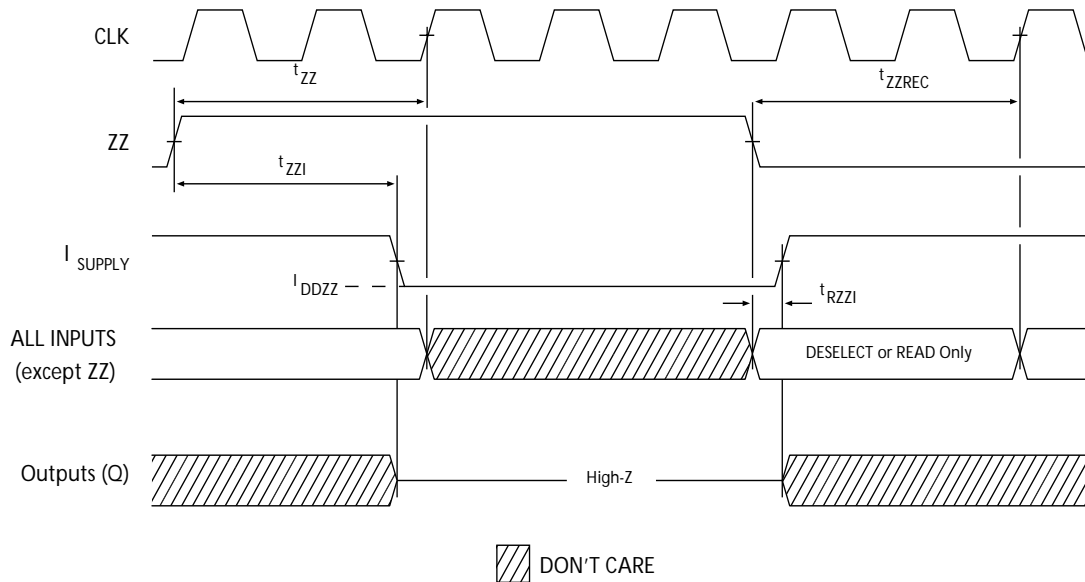
29. The IGNORE CLOCK EDGE or STALL cycle (Clock 3) illustrates $\overline{\text{CEN}}$ being used to create a pause. A write is not performed during this cycle.

Switching Waveforms (continued)
ZZ Mode Timing [30, 31]

Notes:

30. Device must be deselected when entering ZZ mode. See truth table for all possible signal conditions to deselect the device.
 31. DQs are in high-Z when exiting ZZ sleep mode.

Ordering Information

Speed (MHz)	Ordering Code	Package Name	Part and Package Type	Operating Range	
133	CY7C1355C-133AC CY7C1357C-133AC	A101	100-lead Thin Quad Flat Pack (14 x 20 x 1.4mm) 3 Chip Enables	Commercial	
	CY7C1355C-133AI CY7C1357C-133AI	A101	100-lead Thin Quad Flat Pack (14 x 20 x 1.4mm) 3 Chip Enables	Industrial	
	CY7C1355C-133BGC CY7C1357C-133BGC	BG119	119-ball (14 x 22 x 2.4 mm) BGA 3 Chip Enables and JTAG	Commercial	
	CY7C1355C-133BGI CY7C1357C-133BGI	BG119	119-ball (14 x 22 x 2.4 mm) BGA 3 Chip Enables and JTAG	Industrial	
	CY7C1355C-133BZC CY7C1357C-133BZC	BB165D	165-ball Fine-Pitch Ball Grid Array (13 x 15 x 1.4mm) 3 Chip Enables and JTAG	Commercial	
	CY7C1355C-133BZI CY7C1357C-133BZI	BB165D	165-ball Fine-Pitch Ball Grid Array (13 x 15 x 1.4mm) 3 Chip Enables and JTAG	Industrial	
	117	CY7C1355C-117AC CY7C1357C-117AC	A101	100-lead Thin Quad Flat Pack (14 x 20 x 1.4mm) 3 Chip Enables	Commercial
		CY7C1355C-117AI CY7C1357C-117AI	A101	100-lead Thin Quad Flat Pack (14 x 20 x 1.4mm) 3 Chip Enables	Industrial
CY7C1355C-117BGC CY7C1357C-117BGC		BG119	119-ball (14 x 22 x 2.4 mm) BGA 3 Chip Enables and JTAG	Commercial	
CY7C1355C-117BGI CY7C1357C-117BGI		BG119	119-ball (14 x 22 x 2.4 mm) BGA 3 Chip Enables and JTAG	Industrial	

Shaded areas contain advance information.
 Please contact your local sales representative for availability of these parts.



Ordering Information (continued)

Speed (MHz)	Ordering Code	Package Name	Part and Package Type	Operating Range
	CY7C1355C-117BZC	BB165D	165-ball Fine-Pitch Ball Grid Array (13 x 15 x 1.4mm) 3 Chip Enables and JTAG	Commercial
	CY7C1357C-117BZC			
	CY7C1355C-117BZI	BB165D	165-ball Fine-Pitch Ball Grid Array (13 x 15 x 1.4mm) 3 Chip Enables and JTAG	Industrial
	CY7C1357C-117BZI			
100	CY7C1355C-100AC	A101	100-lead Thin Quad Flat Pack (14 x 20 x 1.4mm) 3 Chip Enables	Commercial
	CY7C1357C-100AC			
	CY7C1355C-100AI	A101	100-lead Thin Quad Flat Pack (14 x 20 x 1.4mm) 3 Chip Enables	Industrial
	CY7C1357C-100AI			
	CY7C1355C-100BGC	BG119	119-ball (14 x 22 x 2.4 mm) BGA 3 Chip Enables and JTAG	Commercial
	CY7C1357C-100BGC			
	CY7C1355C-100BGI	BG119	119-ball (14 x 22 x 2.4 mm) BGA 3 Chip Enables and JTAG	Industrial
	ICY7C1357C-100BGI			
	CY7C1355C-100BZC	BB165D	165-ball Fine-Pitch Ball Grid Array (13 x 15 x 1.4mm) 3 Chip Enables and JTAG	Commercial
	CY7C1357C-100BZC			
	CY7C1355C-100BZI	BB165D	165-ball Fine-Pitch Ball Grid Array (13 x 15 x 1.4mm) 3 Chip Enables and JTAG	Industrial
	CY7C1357C-100BZI			

Shaded areas contain advance information.
Please contact your local sales representative for availability of these parts.

Package Diagrams

100-pin Thin Plastic Quad Flatpack (14 x 20 x 1.4 mm) A101

DIMENSIONS ARE IN MILLIMETERS.

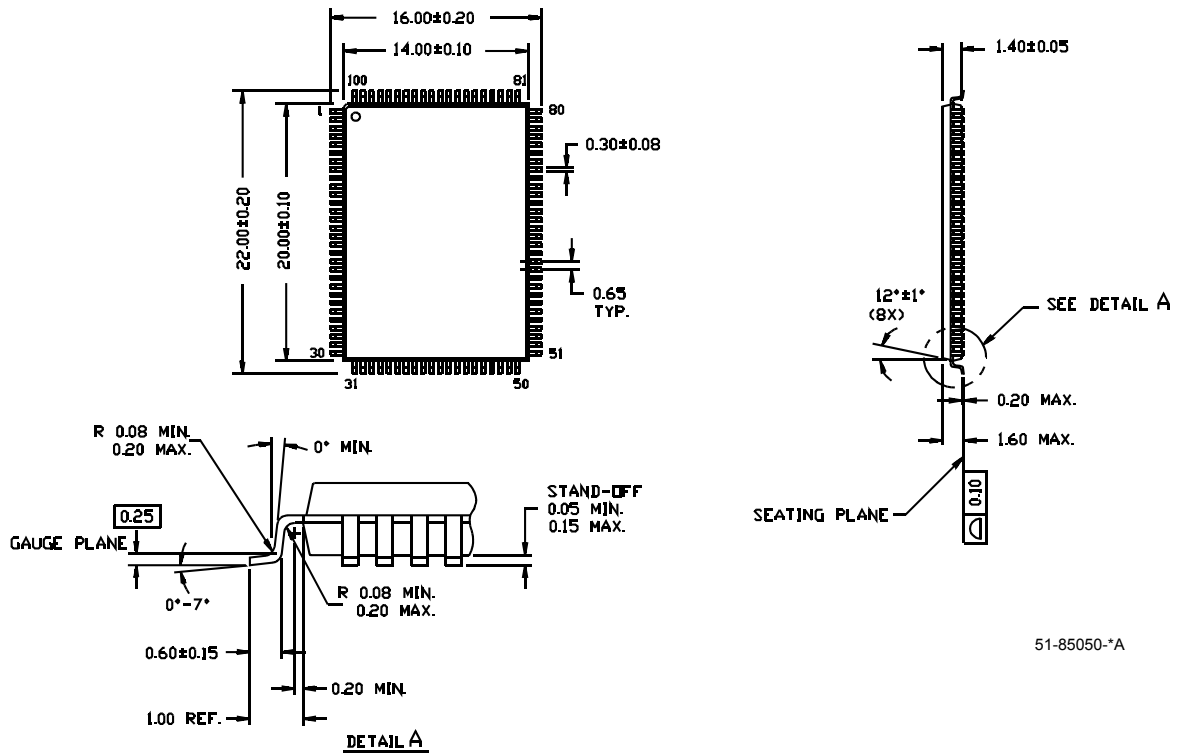

51-85050-A

Package Diagrams (continued)

119-Lead PBGA (14 x 22 x 2.4 mm) BG119

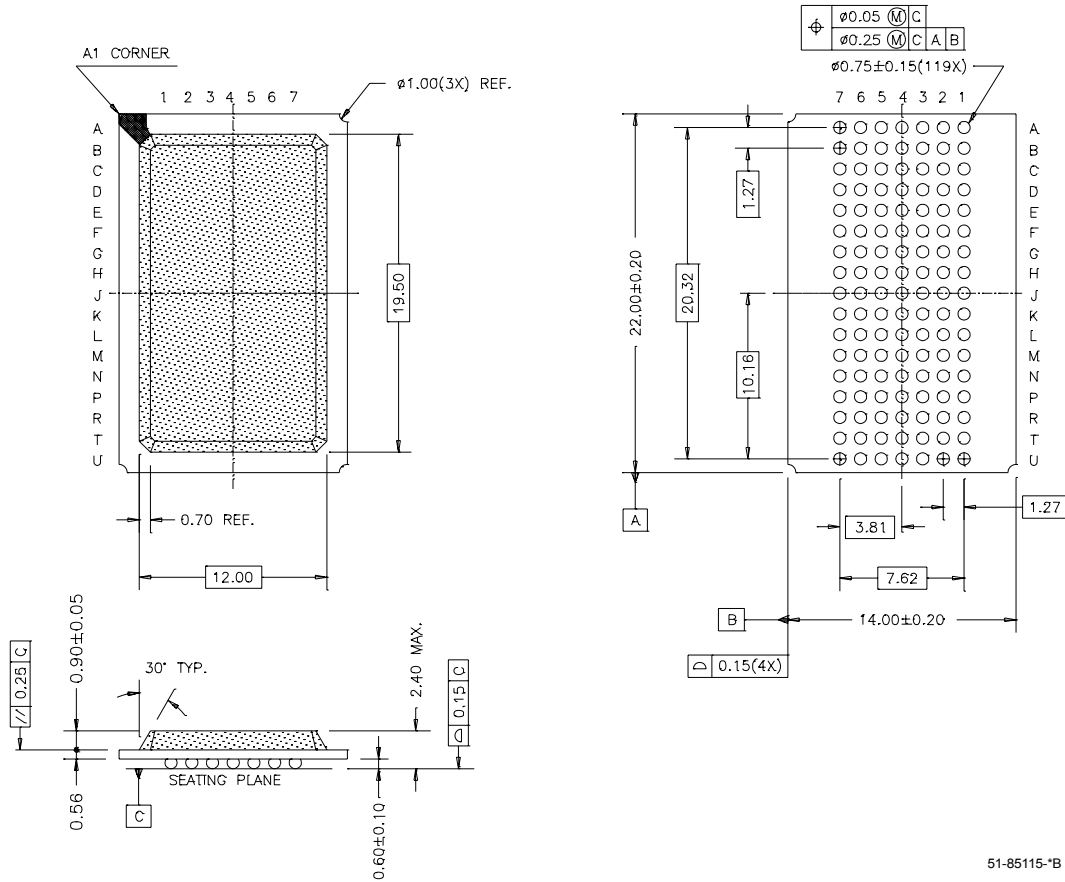

51-85115-B

Package Diagrams (continued)

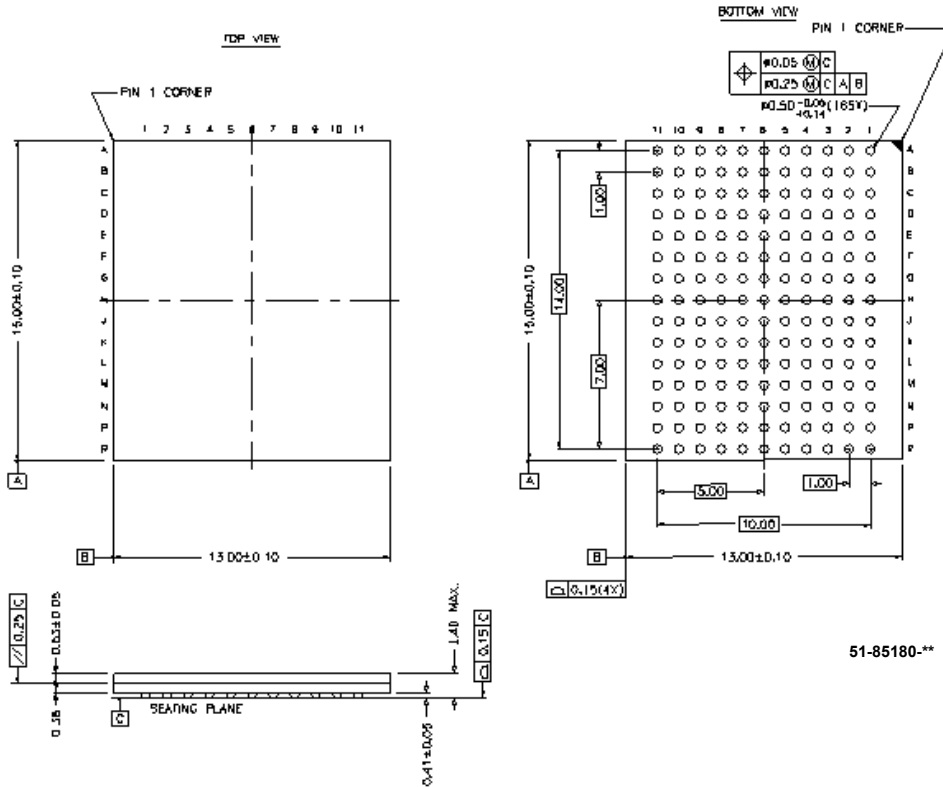
165 FBGA 13 x 15 x 1.40 MM BB165D

NoBL and No Bus Latency are trademarks of Cypress Semiconductor Corporation. ZBT is a trademark of Integrated Device Technology. All product and company names mentioned in this document are the trademarks of their respective holders.