

THYRISTOR MODULE

PCH1508

150A / 800V

FEATURES

- * Isolated Base
- * Thyristor and Diode Cathode Common Circuit
- * High Surge Capability
- * UL Recognized, File No. E187184

TYPICAL APPLICATIONS

- * Rectified For General Use

OUTLINE DRAWING

PCH

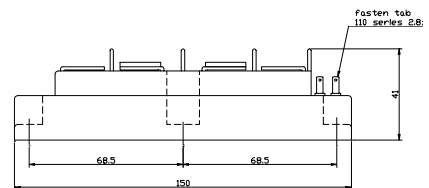
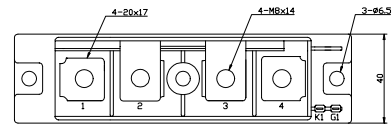
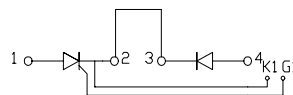

Maximum Ratings

Approx Net Weight:480g

Parameter	Symbol	Grade	Unit
		PCH1508	
Repetitive Peak Off-State Voltage	V_{DRM}	800	V
Non Repetitive Peak Off-State Voltage	V_{DSM}	900	
Repetitive Peak Reverse Voltage	V_{RRM}	800	V
Non Repetitive Peak Reverse Voltage	V_{RSM}	900	

Parameter		Conditions	Max Rated Value	Unit
Average Rectified Output Current	$I_{O(AV)}$	50Hz Half Sine Wave condition $T_c=78^\circ\text{C}$	150	A
RMS On-State Current	$I_{T(RMS)}$		235	A
Surge On-State Current	I_{TSM}	50 Hz Half Sine Wave, 1Pulse Non-Repetitive	3200	A
I Squared t	I^2t	2msec to 10msec	51200	A^2s
Critical Rate of Turned-On Current	di/dt	$V_D=2/3V_{DRM}$, $I_{TM}=2 \cdot I_o$, $T_j=125^\circ\text{C}$ $I_G=300\text{mA}$, $di_G/dt=0.2\text{A}/\mu\text{s}$	100	$\text{A}/\mu\text{s}$
Peak Gate Power	P_{GM}		5	W
Average Gate Power	$P_{G(AV)}$		1	W
Peak Gate Current	I_{GM}		2	A
Peak Gate Voltage	V_{GM}		10	V
Peak Gate Reverse Voltage	V_{RGM}		5	V
Operating Junction Temperature Range	T_{jw}		-40 to +125	$^\circ\text{C}$
Storage Temperature Range	T_{stg}		-40 to +125	$^\circ\text{C}$
Isolation Voltage	Viso	Base Plate to Terminals, AC1min	2000	V
Mounting torque	Case mounting	Ftor	M6 Screw	N.m
	Terminals		M8 Screw	

Value per 1 Arm

Electrical • Thermal Characteristics

Characteristics	Symbol	Test Conditions	Maximum Value.			Unit
			Min.	Typ.	Max.	
Peak Off-State Current	I_{DM}	$V_{DM} = V_{DRM}, T_j = 125^\circ\text{C}$			15	mA
Peak Reverse Current	I_{RM}	$V_{RM} = V_{RRM}, T_j = 125^\circ\text{C}$			15	mA
Peak Forward Voltage	V_{TM}	$I_{TM} = 450\text{A}, T_j = 25^\circ\text{C}$			1.28	V
Gate Current to Trigger	I_{GT}	$V_D = 6\text{V}, I_T = 1\text{A}$	$T_j = -40^\circ\text{C}$		300	mA
			$T_j = 25^\circ\text{C}$		150	
			$T_j = 125^\circ\text{C}$		80	
Gate Voltage to Trigger	V_{GT}	$V_D = 6\text{V}, I_T = 1\text{A}$	$T_j = -40^\circ\text{C}$		5	V
			$T_j = 25^\circ\text{C}$		3	
			$T_j = 125^\circ\text{C}$		2	
Gate Non-Trigger Voltage	V_{GD}	$V_D = 2/3V_{DRM}, T_j = 125^\circ\text{C}$	0.25			V
Critical Rate of Rise of Off-State Voltage	dv/dt	$V_D = 2/3V_{DRM}, T_j = 125^\circ\text{C}$	500			V/ μs
Turn-Off Time	tq	$I_{TM} = I_O, V_D = 2/3V_{DRM}$ $dv/dt = 20\text{V}/\mu\text{s}, V_R = 100\text{V}$ $-di/dt = 20\text{A}/\mu\text{s}, T_j = 125^\circ\text{C}$		100		μs
Turn-On Time	tgt	$V_D = 2/3V_{DRM}, T_j = 125^\circ\text{C}$ $I_G = 300\text{mA}, di_G/dt = 0.2\text{A}/\mu\text{s}$		6		μs
Delay Time	td			2		μs
Rise Time	tr			4		μs
Latching Current	I_L	$T_j = 25^\circ\text{C}$		100		mA
Holding Current	I_H	$T_j = 25^\circ\text{C}$		60		
Thermal Resistance	Rth(j-c)	Junction to Case			0.25	$^\circ\text{C}/\text{W}$
	Rth(c-f)	Base Plate to Heat Sink with Thermal Compound			0.1	

Value Per 1Arm

PCH1508 OUTLINE DRAWING (Dimensions in mm)

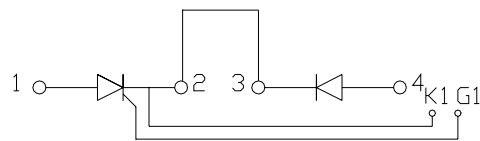
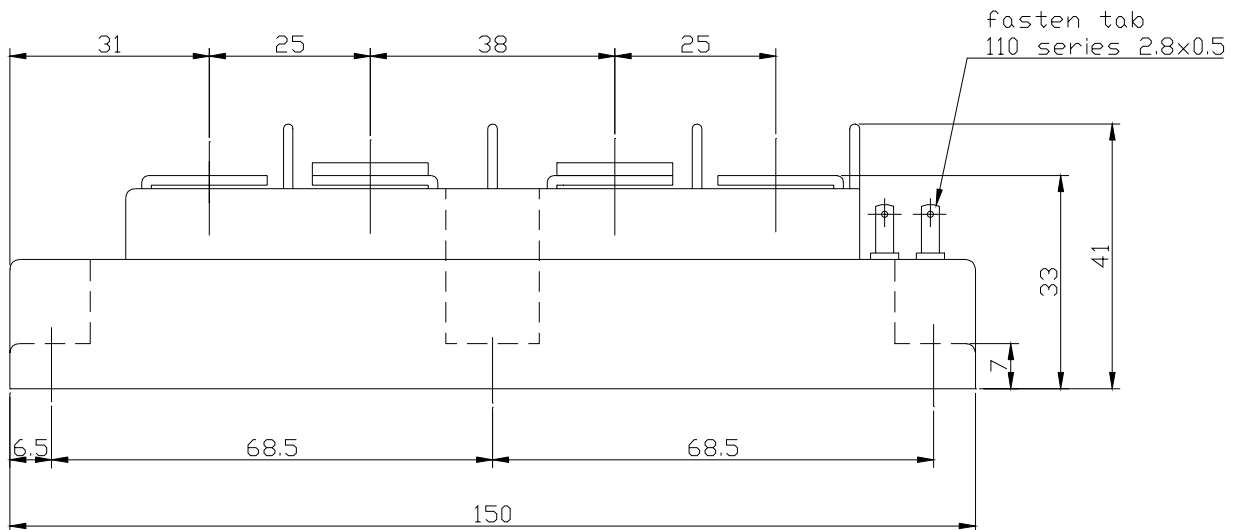
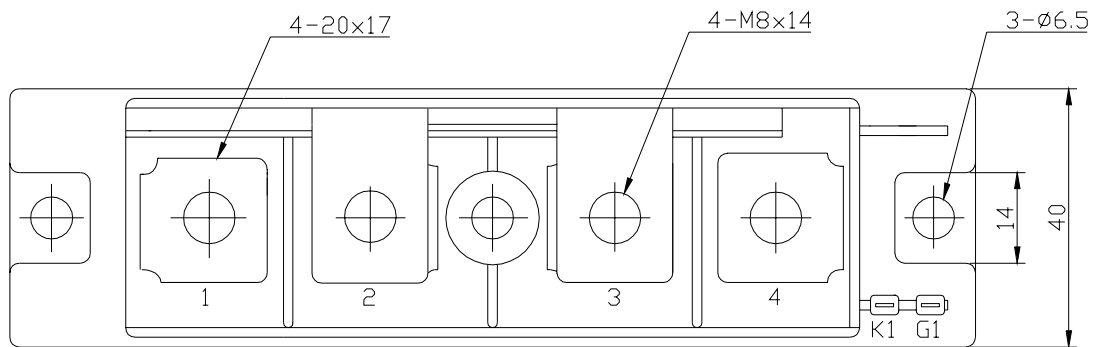

オン電圧特性
ON-STATE CURRENT VS. VOLTAGE

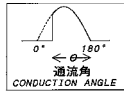
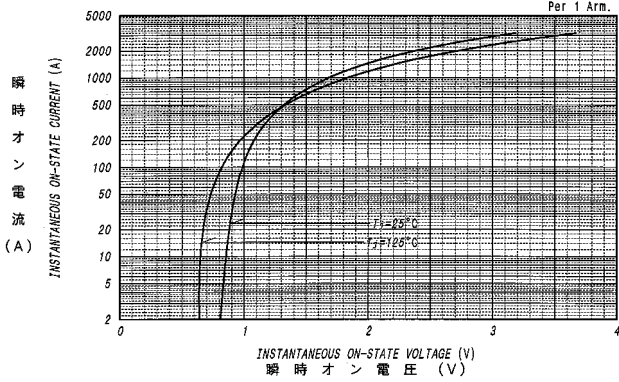

平均オン電力損失特性
AVERAGE ON-STATE POWER DISSIPATION
for SINUSOIDAL CURRENT WAVEFORM

平均オン電力損失 (W)

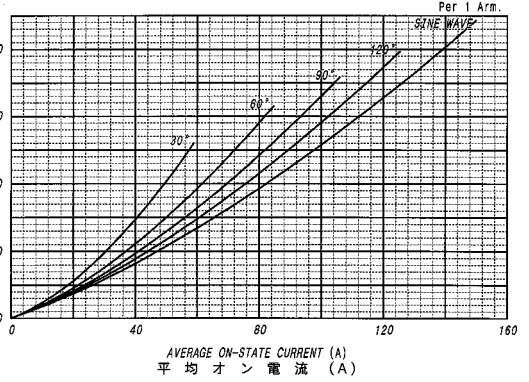

平均オン電力損失特性
AVERAGE ON-STATE POWER DISSIPATION
for RECTANGULAR CURRENT WAVEFORM

平均オン電力損失 (W)

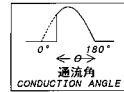
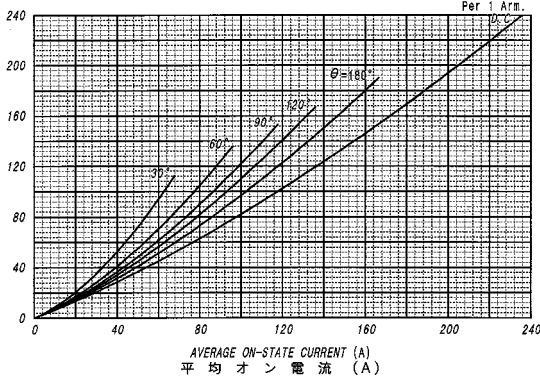

平均オン電流 - ケース温度定格
AVERAGE ON-STATE CURRENT VS. CASE TEMPERATURE

平均オン電流 (A)

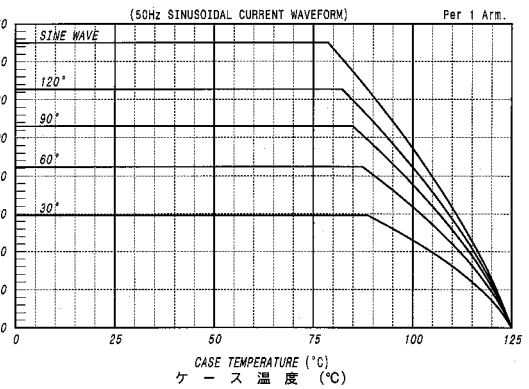

平均オン電流 - ケース温度定格
AVERAGE ON-STATE CURRENT VS. CASE TEMPERATURE

平均オン電流 (A)

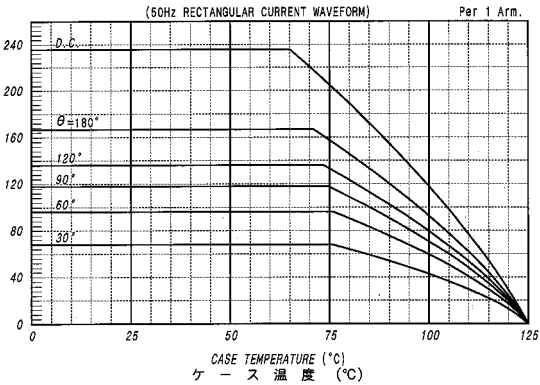

サージオン電流定格
SURGE CURRENT RATINGS

サージオン電流 (A)

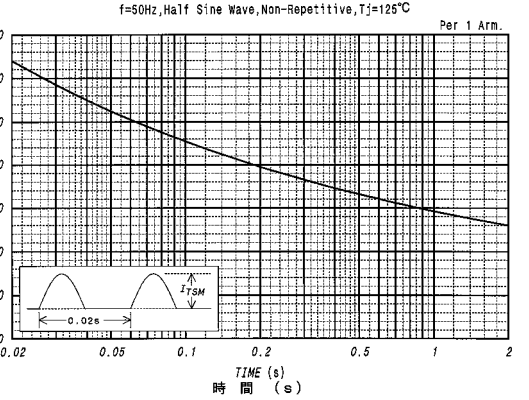

ゲート特性
GATE CHARACTERISTICS

トリガゲート電圧 (V)

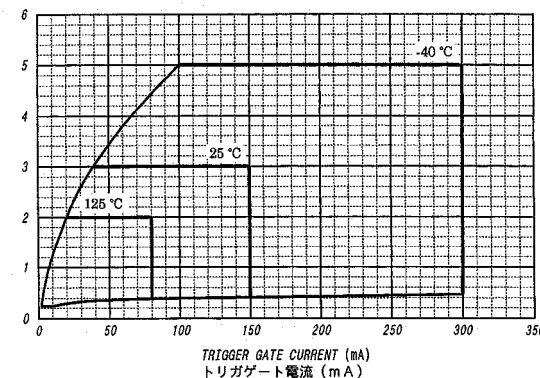

ゲート定格
GATE RATINGS

ゲート電圧 (V)

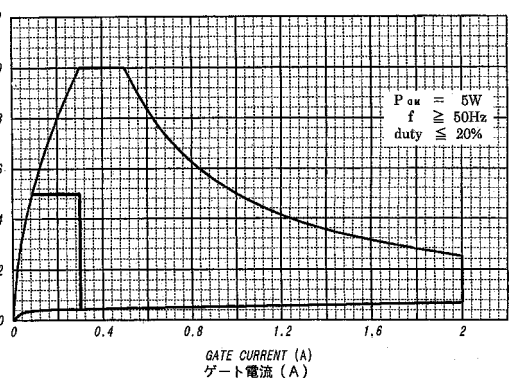

過渡熱抵抗特性
MAXIMUM TRANSIENT THERMAL IMPEDANCE
Junction to Case

Per 1 Arm.

