

FEATURES

- DC - 450 MHz
- 20 Watts CW
- Non-Reflective
- SMA Connectors



MODEL NO.
100C0613

SP4T RELAY

SP4T

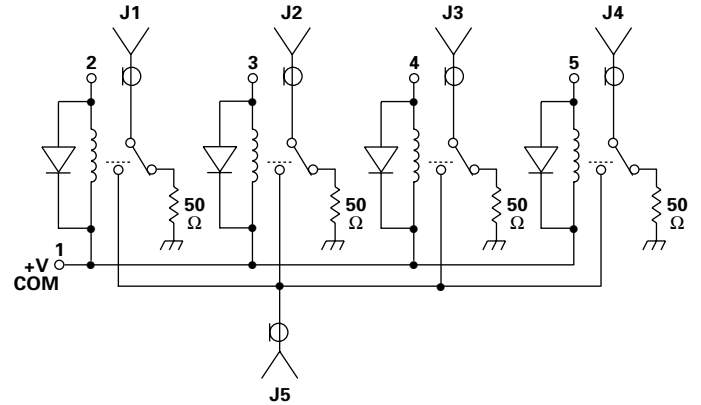
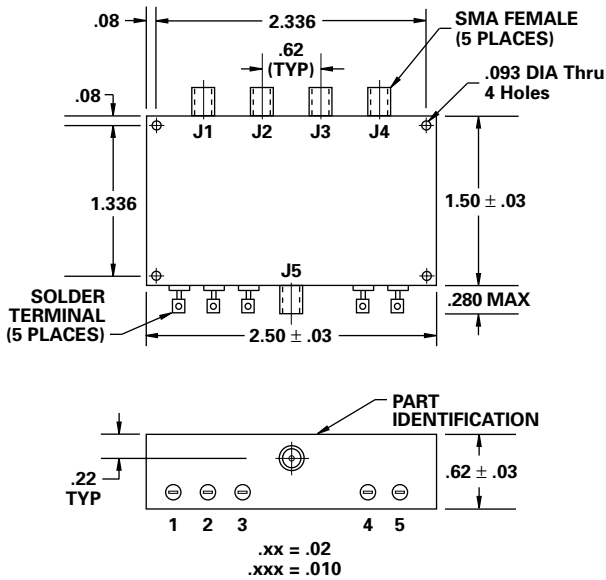

GUARANTEED PERFORMANCE

Parameter	Min	Typ	Max	Units	Conditions
Operating Frequency	DC		450	MHz	
DC Voltage					See Table
Insertion Loss		0.25	0.35	dB	DC - 200 MHz
		0.40	0.5	dB	200 - 450 MHz
Isolation	60	70		dB	DC - 250 MHz
	50	60		dB	250 - 450 MHz
VSWR	Thru	1.05/1	1.1/1		DC - 200 MHz
		1.15/1	1.25/1		200 - 450 MHz
Impedance		50		OHMS	
Switching Speed			5	mSEC	
RF Power			20	W	CW
Operating Temperature	-55	+25	+85	°C	TA

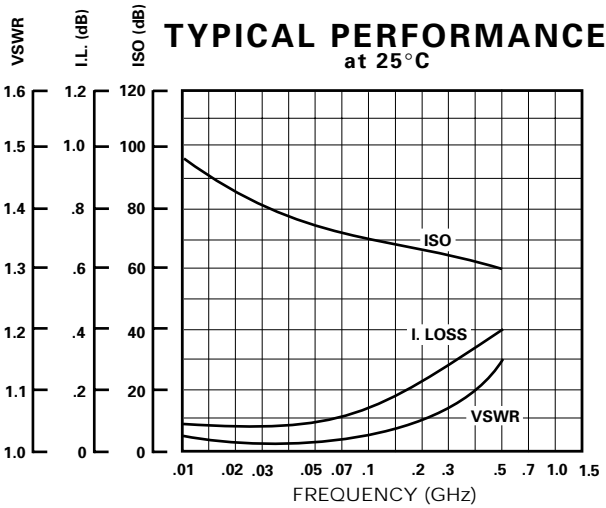

Voltage	Current - Typical
6	65 mA per throw
12	32 mA per throw
18	21 mA per throw
26	17 mA per throw

PART NO. EXAMPLE - SEE TABLE
100C0613 - 26

Basic Part Number | Dash No. same as coil voltage