

# 2SA1619, 2SA1619A

Silicon PNP epitaxial planer type

For low-frequency power amplification and driver amplification  
Complementary to 2SC4208 and 2SC4208A

## ■ Features

- Complementary pair with 2SC4208 and 2SC4208A.
- Allowing supply with the radial taping and automatic insertion possible.

## ■ Absolute Maximum Ratings (Ta=25°C)

Parameter	Symbol	Ratings	Unit
Collector to base voltage	2SA1619	-30	V
	2SA1619A	-60	
Collector to emitter voltage	2SA1619	-25	V
	2SA1619A	-50	
Emitter to base voltage	V <sub>EBO</sub>	-5	V
Peak collector current	I <sub>CP</sub>	-1	A
Collector current	I <sub>C</sub>	-0.5	A
Collector power dissipation	P <sub>C</sub>	1	W
Junction temperature	T <sub>j</sub>	150	°C
Storage temperature	T <sub>stg</sub>	-55 ~ +150	°C

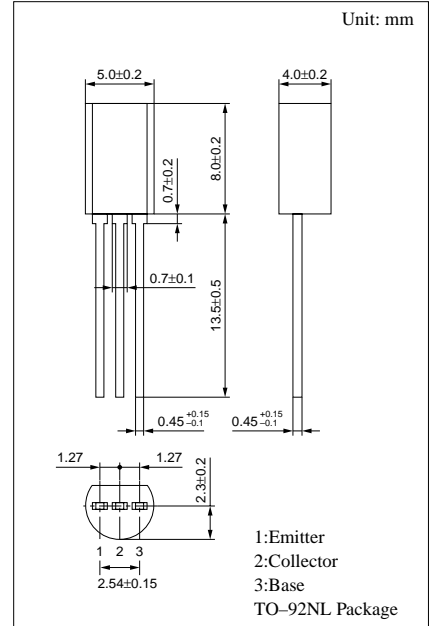

## ■ Electrical Characteristics (Ta=25°C)

Parameter	Symbol	Conditions	min	typ	max	Unit
Collector cutoff current	I <sub>CBO</sub>	V <sub>CB</sub> = -20V, I <sub>E</sub> = 0			-0.1	μA
Collector to base voltage	2SA1619	I <sub>C</sub> = -10μA, I <sub>E</sub> = 0	-30			V
	2SA1619A		-60			
Collector to emitter voltage	2SA1619	I <sub>C</sub> = -10mA, I <sub>B</sub> = 0	-25			V
	2SA1619A		-50			
Emitter to base voltage	V <sub>EBO</sub>	I <sub>E</sub> = -10μA, I <sub>C</sub> = 0	-5			V
Forward current transfer ratio	h <sub>FE1</sub> *	V <sub>CE</sub> = -10V, I <sub>C</sub> = -150mA	85	160	340	
	h <sub>FE2</sub>	V <sub>CE</sub> = -10V, I <sub>C</sub> = -500mA	40			
Collector to emitter saturation voltage	V <sub>CE(sat)</sub>	I <sub>C</sub> = -300mA, I <sub>B</sub> = -30mA		-0.35	-0.6	V
Base to emitter saturation voltage	V <sub>BE(sat)</sub>	I <sub>C</sub> = -300mA, I <sub>B</sub> = -30mA		-1.1	-1.5	V
Transition frequency	f <sub>T</sub>	V <sub>CB</sub> = -10V, I <sub>E</sub> = 50mA, f = 200MHz		200		MHz
Collector output capacitance	C <sub>ob</sub>	V <sub>CB</sub> = -10V, I <sub>E</sub> = 0, f = 1MHz		6	15	pF

\*h<sub>FE1</sub> Rank classification

Rank	Q	R	S
h <sub>FE1</sub>	85 ~ 170	120 ~ 240	170 ~ 340

$P_C - T_a$

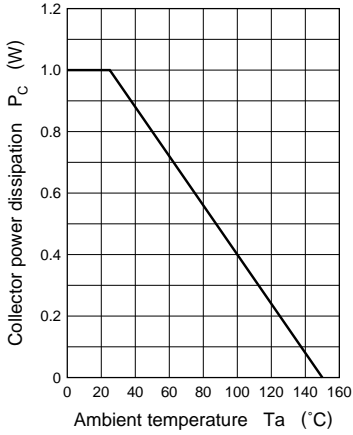

$I_C - V_{CE}$

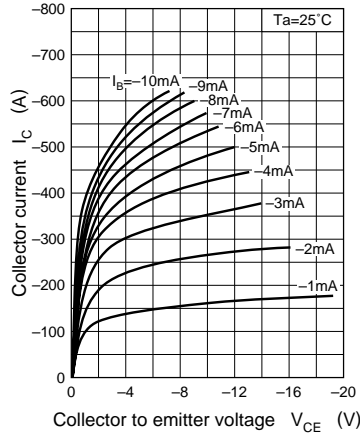

$I_C - I_B$

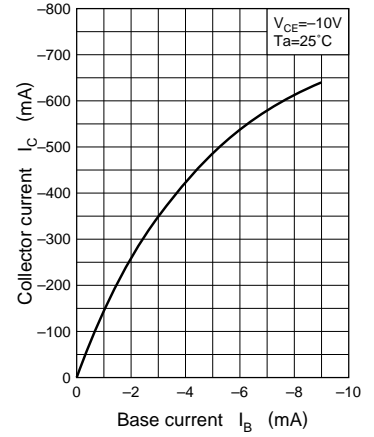

$V_{CE(sat)} - I_C$

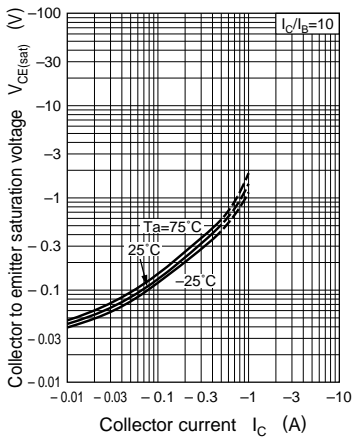

$V_{BE(sat)} - I_C$

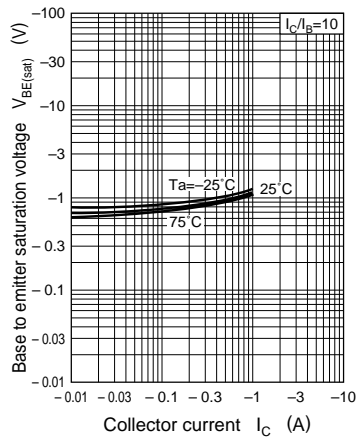

$h_{FE} - I_C$

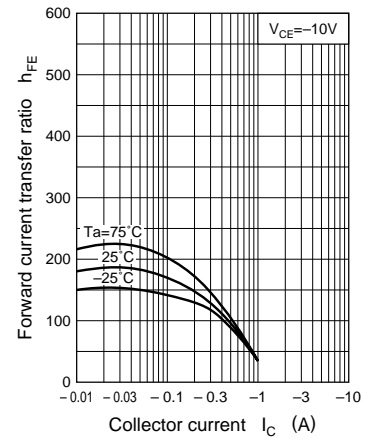

$f_T - I_E$

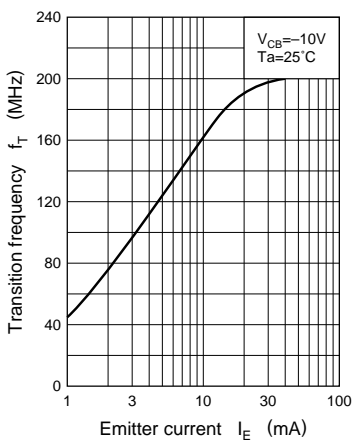

$C_{ob} - V_{CB}$

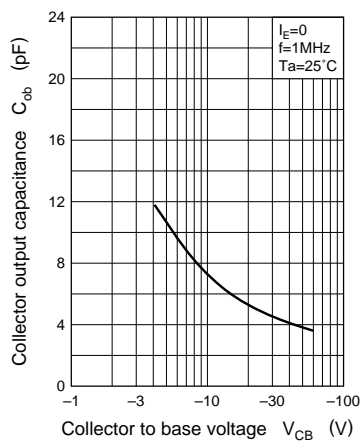

$V_{CER} - R_{BE}$

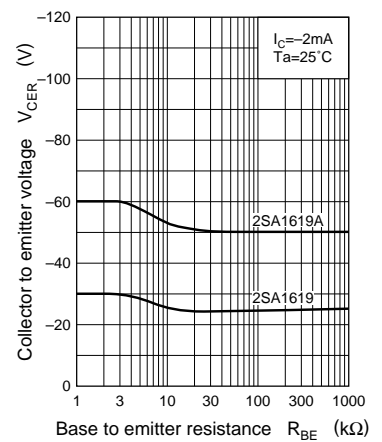

$I_{CEO} - T_a$

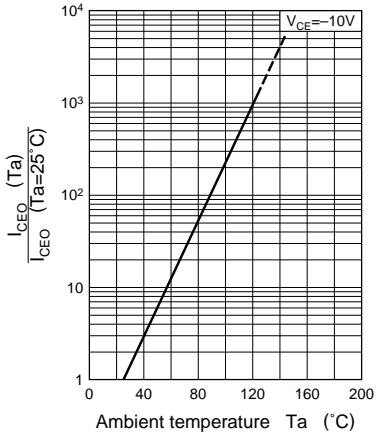

Area of safe operation (ASO)

