

SANYO	No.1201C	2SA1291/2SC3255
	PNP/NPN Epitaxial Planar Silicon Transistors	
60V/10A High-Speed Switching Applications		

Applications

- Various inductance lamp drivers for electrical equipment.
- Inverters, converters (strobo, flash, fluorescent lamp lighting circuit).
- Power amp (high power car stereo, motor controller).
- High-speed switching (switching regulator, driver).

Features

- Low saturation voltage.
- Excellent current dependence of h_{FE} .
- Short switching time.

() : 2SA1291

Absolute Maximum Ratings at $T_a = 25^\circ\text{C}$

			unit
Collector-to-Base Voltage	V_{CBO}	(-)80	V
Collector-to-Emitter Voltage	V_{CEO}	(-)60	V
Emitter-to-Base Voltage	V_{EBO}	(-)5	V
Collector Current	I_C	(-)10	A
Collector Current (Pulse)	I_{CP}	(-)12	A
Collector Dissipation	P_C	40	W
Junction Temperature	T_j	150	$^\circ\text{C}$
Storage Temperature	T_{stg}	-55 to +150	$^\circ\text{C}$

$T_c = 25^\circ\text{C}$

Electrical Characteristics at $T_a = 25^\circ\text{C}$

			min	typ	max	unit
Collector Cutoff Current	I_{CBO}	$V_{CB} = (-)40\text{V}, I_E = 0$			(-)0.1	mA
Emitter Cutoff Current	I_{EBO}	$V_{EB} = (-)4\text{V}, I_C = 0$			(-)0.1	mA
DC Current Gain	h_{FE}	$V_{CE} = (-)2\text{V}, I_C = (-)1\text{A}$	70*		280*	
Gain-Bandwidth Product	f_T	$V_{CE} = (-)5\text{V}, I_C = (-)1\text{A}$		100		MHz
C-E Saturation Voltage	$V_{CE(sat)}$	$I_C = (-)5\text{A}, I_B = (-)0.25\text{A}$			(-)0.4	V
C-B Breakdown Voltage	$V_{(BR)CBO}$	$I_C = (-)1\text{mA}, I_E = 0$	(-)80			V
C-E Breakdown Voltage	$V_{(BR)CEO}$	$I_C = (-)1\text{mA}, R_{BE} = \infty$	(-)60			V
E-B Breakdown Voltage	$V_{(BR)EBO}$	$I_E = (-)1\text{mA}, I_C = 0$	(-)5			V
Turn-on Time	t_{on}	See specified Test Circuit.		0.1		μs
Storage Time	t_{stg}	"		0.5		μs
Fall Time	t_f	"		0.1		μs

* : The 2SA1291/2SC3255 are classified by 1A h_{FE} as follows

70	Q	140	100	R	200	140	S	280
----	---	-----	-----	---	-----	-----	---	-----

Switching Time Test Circuit

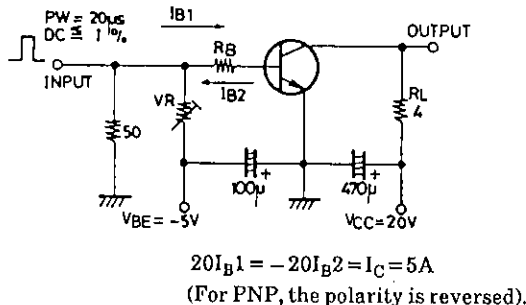

Package Dimensions 2010B

(unit : mm)

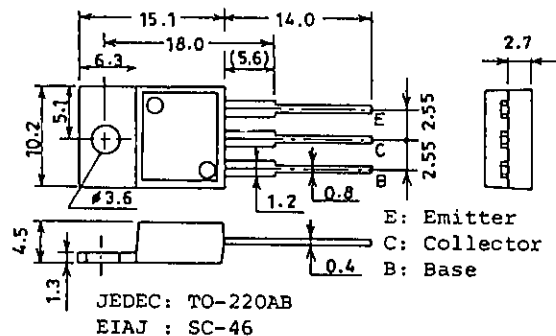

2SA1291/2SC3255

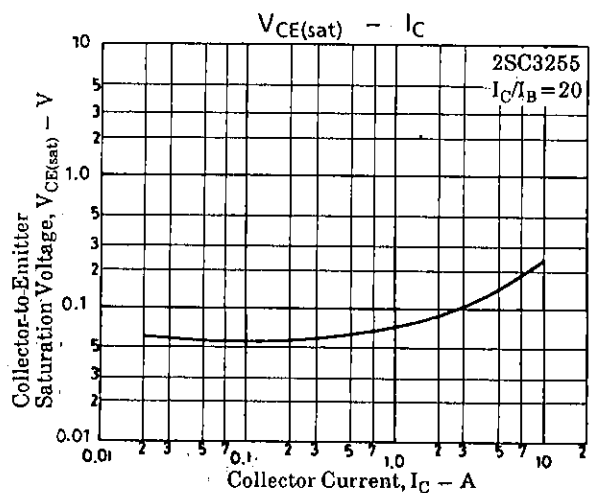
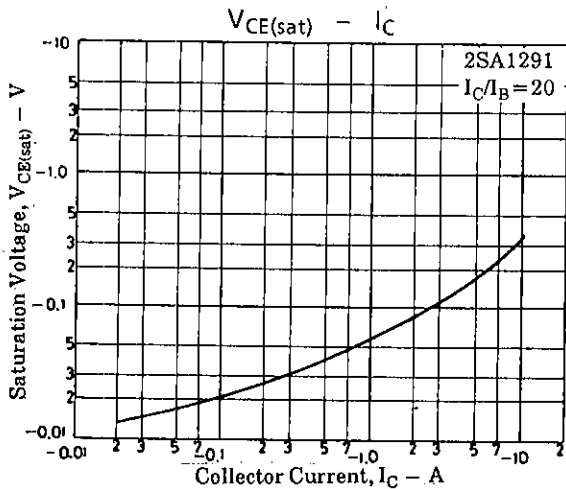
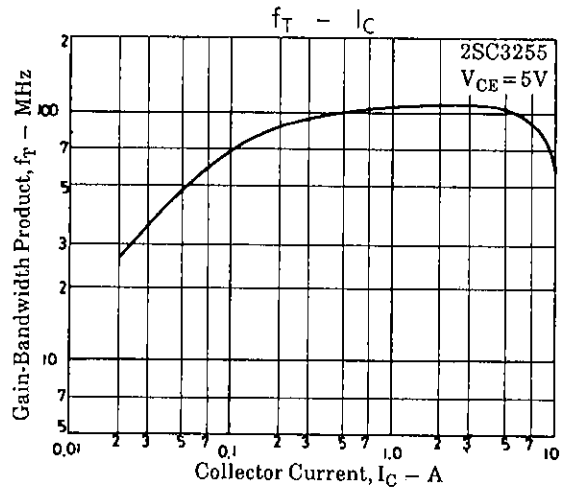
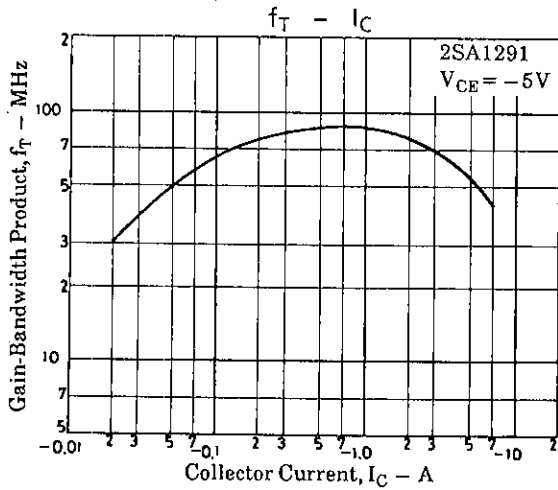
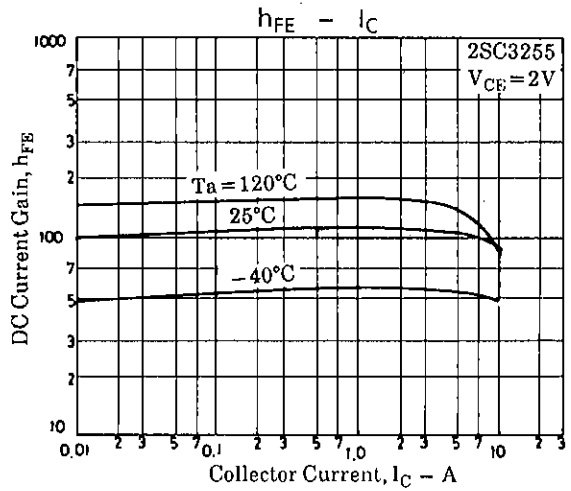
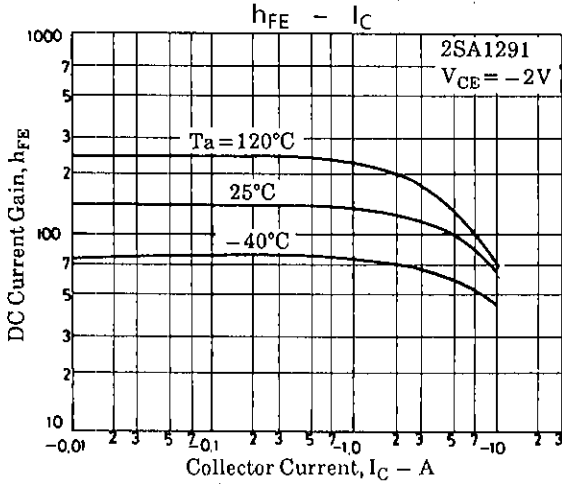
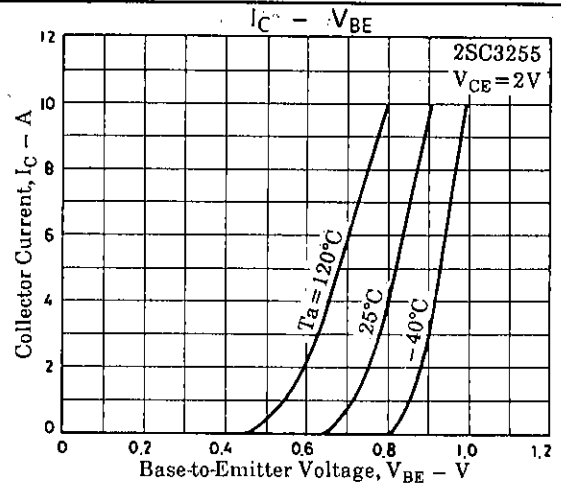
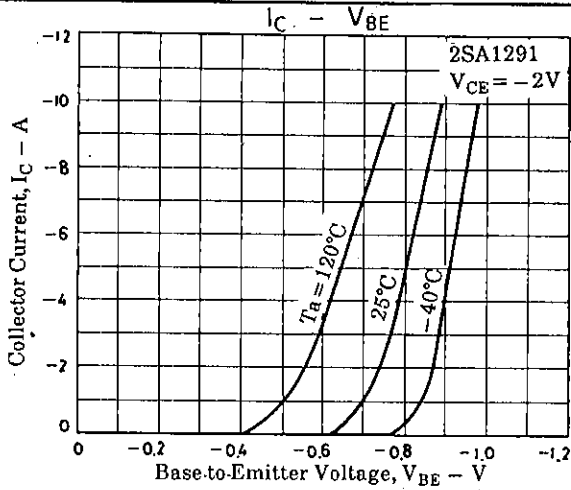

2SA1291/2SC3255

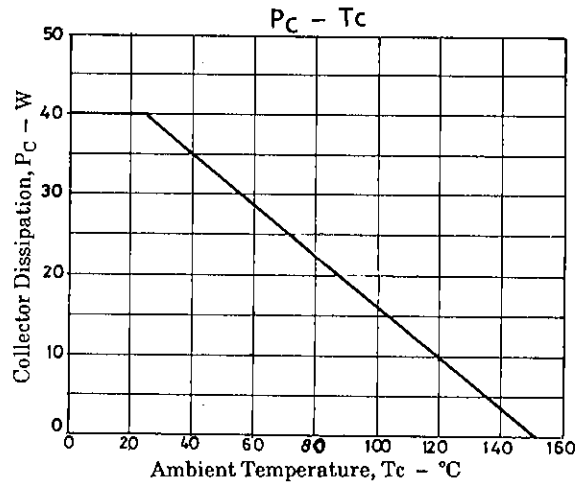
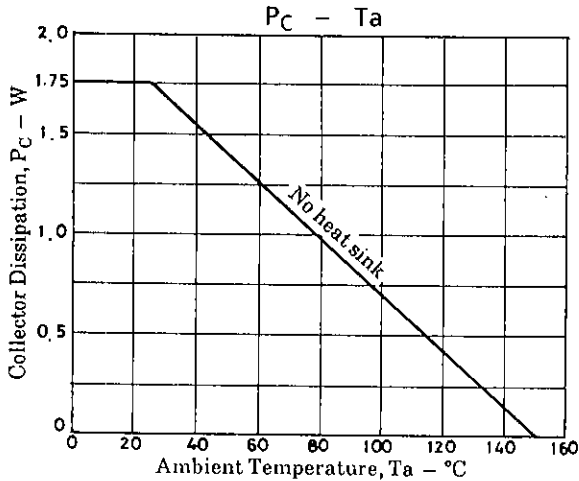
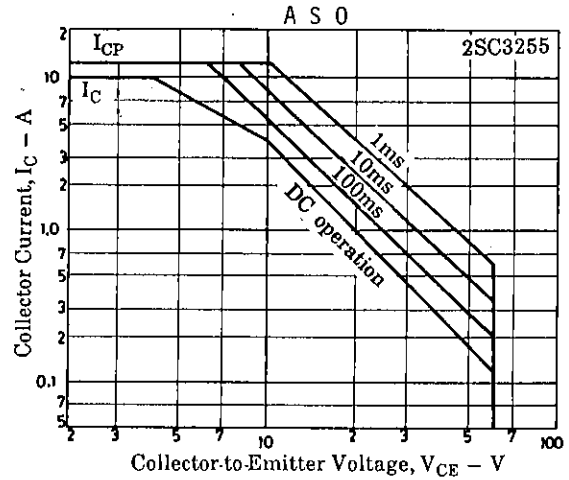
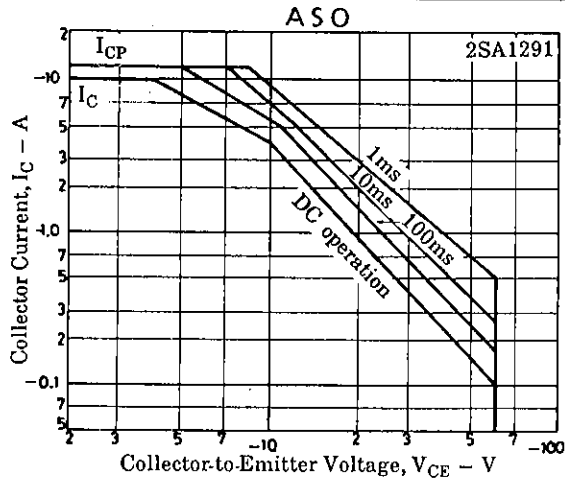

- No products described or contained herein are intended for use in surgical implants, life-support systems, aerospace equipment, nuclear power control systems, vehicles, disaster/crime-prevention equipment and the like, the failure of which may directly or indirectly cause injury, death or property loss.
- Anyone purchasing any products described or contained herein for an above-mentioned use shall:
 - ① Accept full responsibility and indemnify and defend SANYO ELECTRIC CO., LTD., its affiliates, subsidiaries and distributors and all their officers and employees, jointly and severally, against any and all claims and litigation and all damages, cost and expenses associated with such use.
 - ② Not impose any responsibility for any fault or negligence which may be cited in any such claim or litigation on SANYO ELECTRIC CO., LTD., its affiliates, subsidiaries and distributors or any of their officers and employees jointly or severally.
- Information (including circuit diagrams and circuit parameters) herein is for example only; it is not guaranteed for volume production. SANYO believes information herein is accurate and reliable, but no guarantees are made or implied regarding its use or any infringements of intellectual property rights or other rights of third parties.