

**SANYO**

No.3363

**2SB1467/2SD2218**

PNP/NPN Epitaxial Planar Silicon Transistors

General High-current  
Switching Applications**Applications**

- Relay drivers, high-speed inverters, converters

**Features**

- Micaless package facilitating mounting
- Low collector-to-emitter saturation voltage:  $V_{CE(sat)} = -0.5V(\text{PNP}), 0.4V(\text{NPN})$  max
- Large current capacity

( ) : 2SB1467

**Absolute Maximum Ratings at  $T_a = 25^\circ\text{C}$** 

			unit
Collector-to-Base Voltage	$V_{CB0}$	(-)60	V
Collector-to-Emitter Voltage	$V_{CE0}$	(-)30	V
Emitter-to-Base Voltage	$V_{EB0}$	(-)6	V
Collector Current	$I_C$	(-)8	A
Collector Current (Pulse)	$I_{CP}$	(-)15	A
Collector Dissipation	$P_C$	2	W
		20	W
Junction Temperature	$T_j$	150	$^\circ\text{C}$
Storage Temperature	$T_{stg}$	-55 to +150	$^\circ\text{C}$

 $T_c = 25^\circ\text{C}$ **Electrical Characteristics at  $T_a = 25^\circ\text{C}$** 

			min	typ	max	unit
Collector Cutoff Current	$I_{CBO}$	$V_{CB} = (-)40V, I_E = 0$			(-)0.1	mA
Emitter Cutoff Current	$I_{EBO}$	$V_{EB} = (-)4V, I_C = 0$			(-)0.1	mA
DC Current Gain	$h_{FE(1)}^*$	$V_{CE} = (-)2V, I_C = (-)1A$	70*		280*	
	$h_{FE(2)}$	$V_{CE} = (-)2V, I_C = (-)4A$	30			
Gain-Bandwidth Product	$f_T$	$V_{CE} = (-)5V, I_C = (-)1A$		120		MHz
C-E Saturation Voltage	$V_{CE(sat)}$	$I_C = (-)3A, I_B = (-)0.15A$			(-0.5)	V
					0.4	V
C-B Breakdown Voltage	$V_{(BR)CBO}$	$I_C = (-)1mA, I_E = 0$	(-)60			V
C-E Breakdown Voltage	$V_{(BR)CEO}$	$I_C = (-)1mA, R_{BE} = \infty$	(-)30			V
E-B Breakdown Voltage	$V_{(BR)EBO}$	$I_E = (-)1mA, I_C = 0$	(-)6			V
Turn-ON time	$t_{on}$	See specified Test Circuit.		0.1		$\mu\text{s}$
Storage Time	$t_{stg}$	Same as above.		(0.2)0.5		$\mu\text{s}$
Fall Time	$t_f$	Same as above.		0.03		$\mu\text{s}$

\* : The 2SB1467/2SD2218 are classified by 1A  $h_{FE}$  as follows :

70 Q 140	100 R 200	140 S 280
----------	-----------	-----------

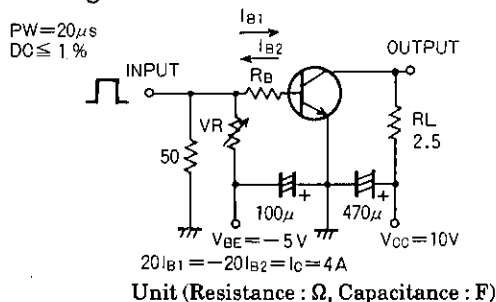
**Switching Time Test Circuit****Package Dimensions 2041**

(unit : mm)

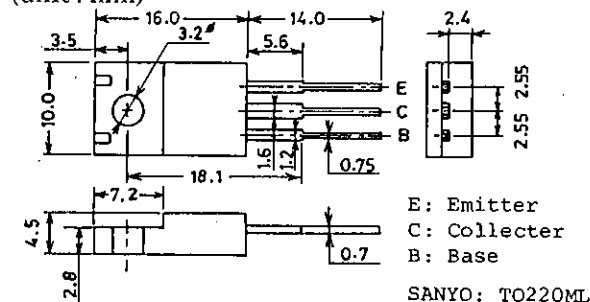
E: Emitter  
C: Collector  
B: Base

SANYO: TO220ML

**SANYO Electric Co., Ltd. Semiconductor Business Headquarters**  
TOKYO OFFICE Tokyo Bldg., 1-10, 1 Chome, Ueno, Taito-ku, TOKYO, 110 JAPAN

N120MH,JK(KOTO) No.3363-1/3

2SB1467/2SD2218

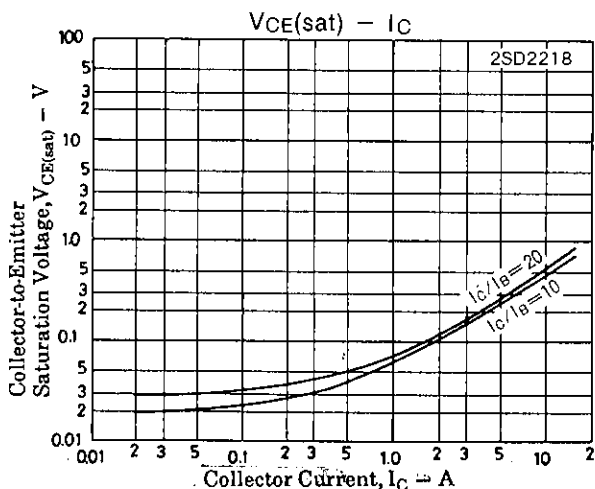
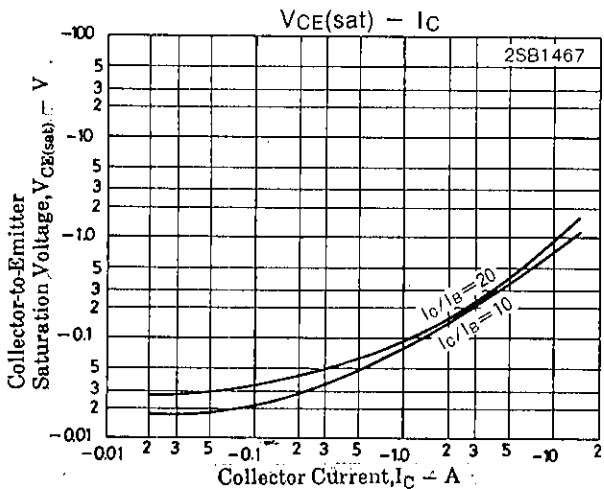
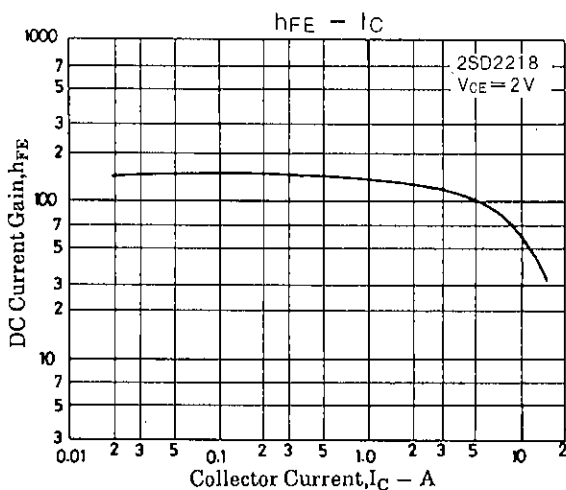
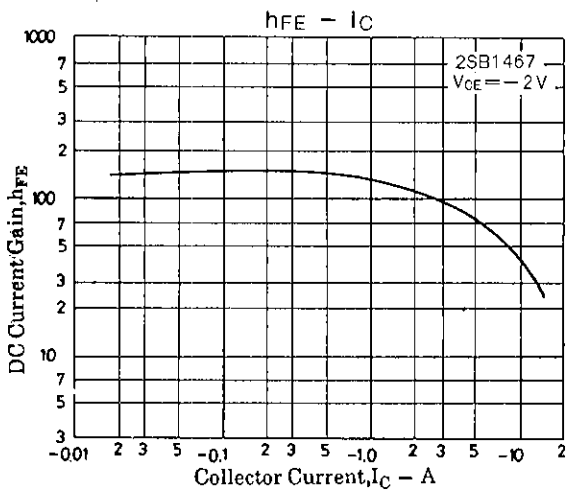
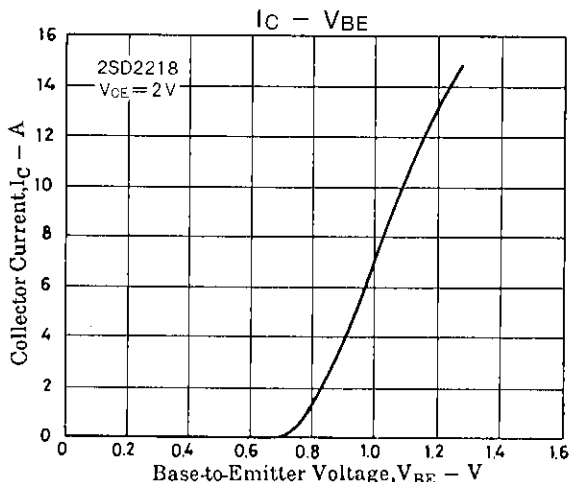
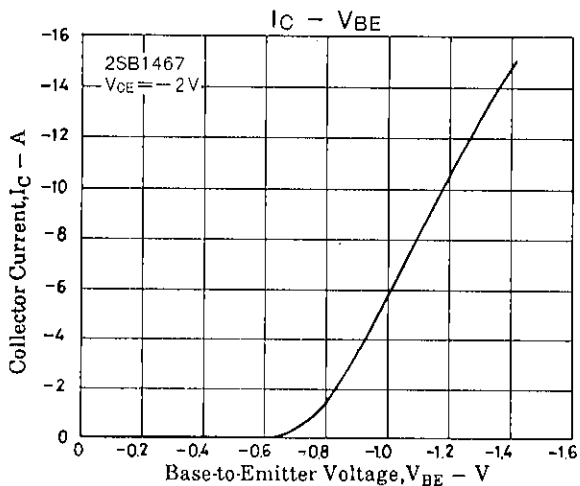
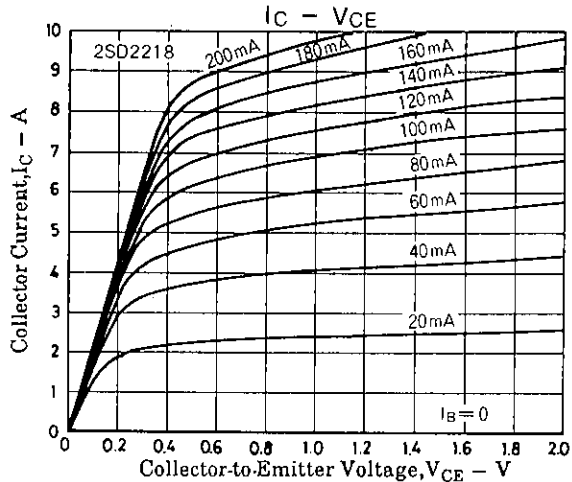
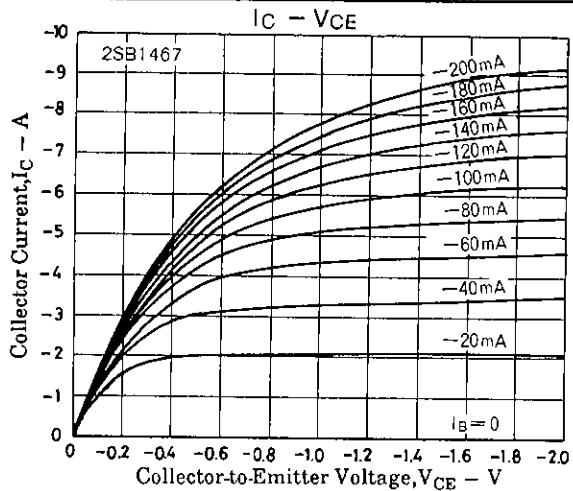

# 2SB1467/2SD2218

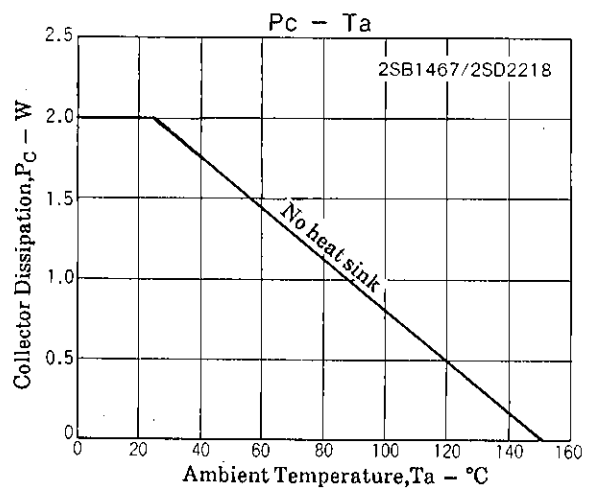
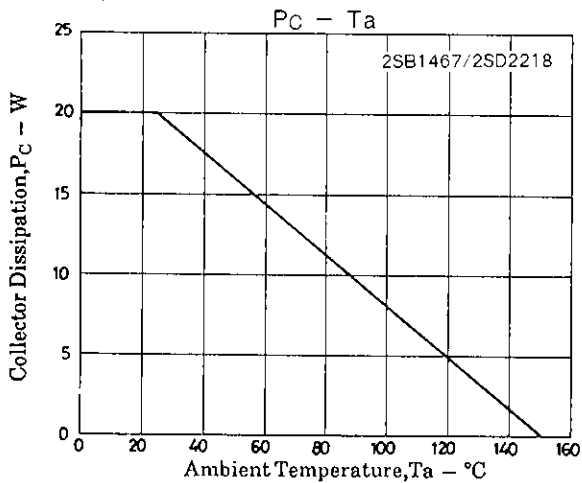
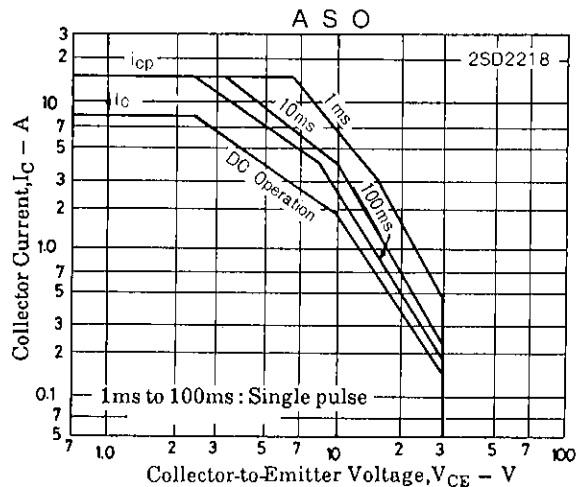
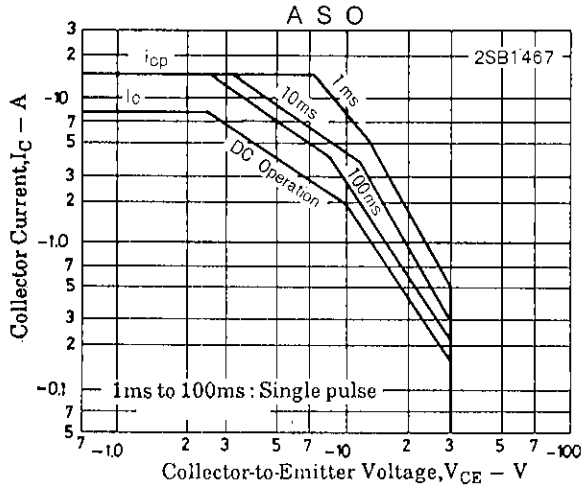
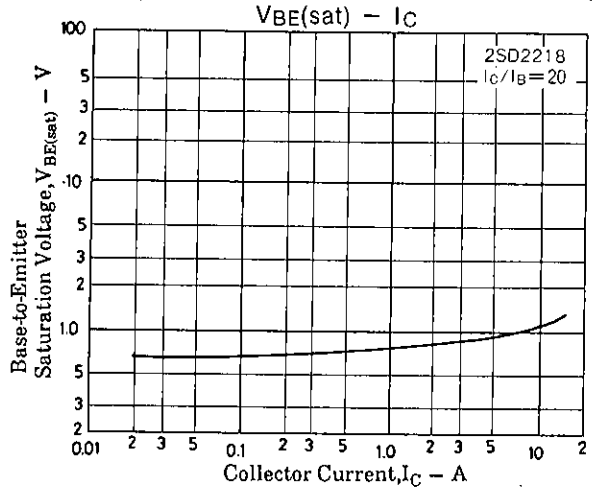
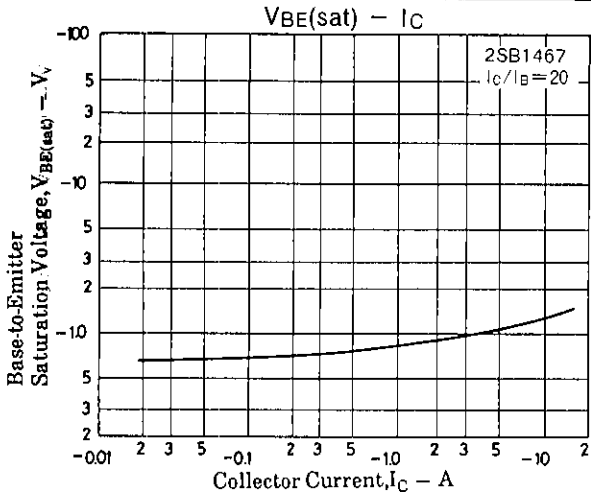

■ No products described or contained herein are intended for use in surgical implants, life-support systems, aerospace equipment, nuclear power control systems, vehicles, disaster/crime-prevention equipment and the like, the failure of which may directly or indirectly cause injury, death or property loss.

■ Anyone purchasing any products described or contained herein for an above-mentioned use shall:

- ① Accept full responsibility and indemnify and defend SANYO ELECTRIC CO., LTD., its affiliates, subsidiaries and distributors and all their officers and employees, jointly and severally, against any and all claims and litigation and all damages, cost and expenses associated with such use;
- ② Not impose any responsibility for any fault or negligence which may be cited in any such claim or litigation on SANYO ELECTRIC CO., LTD., its affiliates, subsidiaries and distributors or any of their officers and employees jointly or severally.

■ Information (including circuit diagrams and circuit parameters) herein is for example only; it is not guaranteed for volume production. SANYO believes information herein is accurate and reliable, but no guarantees are made or implied regarding its use or any infringements of intellectual property rights or other rights of third parties.