

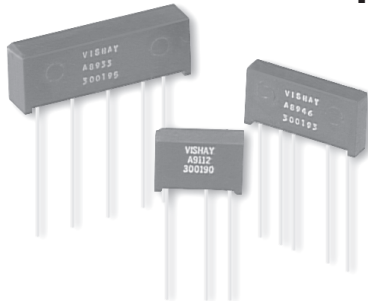

Bulk Metal[®] Foil Technology Molded Resistor Networks



Product may not be to scale

Unitized Resistor Networks are comprised of Vishay S102C elements combined and molded into single units. This method of making networks yields some important advantages that should be considered where space is not a limitation and maximizing performance is important. To begin with, the leads that emerge from the package go directly to the resistance element (or an internal PC board), so the possibility of thermal EMFs is very low. Next, the value range of the elements is large (1 ohms to 150Kohms in a single foil element) and they can be combined for even higher values. Finally, these elements possess all the good features of discrete Bulk Metal[®] Foil resistors, plus the ability to be further sorted for TCR track and absolute match before encapsulation. These networks make excellent voltage dividers, bridges, and attenuators where performance and stability are important.

THROUGH HOLE

APPLICATIONS

- Differential amplifiers
- Gain defining resistors in digital voltmeters
- Ratio arms in bridge circuits
- Fuel metering systems
- Heads up displays
- Fire control systems
- Spacecraft instrumentation
- Naval weapons systems
- Binary Coded Decimal Ladder Networks
- Binary Ladders (A-D, D-A conversion, current and voltage summing)
- Ratio and Ratio-matching Networks
- Bridge Networks
- Synchro Input and Summing Networks
- Resolver Networks
- Linear and Linear-summing Networks
- Decoder Networks
- Quadrature Bridge Networks
- Resistive Summing Networks

FEATURES

- Resistance range each resistor: 1Ω to 150KΩ
- TCR Tracking: to ± 0.5ppm/°C
- Nominal TCR each resistor: See Figures 1 and 2 in data sheet "7 Technical Reasons to Specify Bulk Metal[®] Foil Resistor Networks."
- Nominal tolerance ratio matching between resistors: from ± 0.005 to ± 1%
- Absolute tolerance each resistor: ± 1.0%, ± 0.5%, ± 0.25%, ± 0.1%, ± 0.05%, ± 0.02%, ± 0.01%, ± 0.005%
- Power rating: 0.25 watts per resistor

TABLE 1 - TYPICAL ⁽¹⁾ PERFORMANCE CHARACTERISTICS

| | | | |
|--------------------------------------|-----------------------|-------------------------------------|--------|
| Resistance Temp Characteristic (TCR) | | ± 2ppm/°C nominal | |
| TCR Tracking To Reference Element | | 0.1ppm/°C to 4ppm/°C ⁽⁴⁾ | |
| Max Ambient Temp at Rated Wattage | | + 125°C | |
| Max Ambient Temp at Zero Power | | + 175°C | |
| Thermal Shock | ΔR ⁽²⁾ | 0.002% | |
| | ΔRatio ⁽³⁾ | 0.002% | |
| Low Temperature Operation | ΔR | 0.005% | |
| | ΔRatio | 0.002% | |
| Short Time Overload | ΔR | 0.002% | |
| | ΔRatio | 0.002% | |
| Terminal Strength | ΔR | 0.001% | |
| | ΔRatio | 0.001% | |
| Resistance to Soldering Heat | ΔR | 0.002% | |
| | ΔRatio | 0.001% | |
| Moisture Resistance | ΔR | 0.003% | |
| | ΔRatio | 0.003% | |
| Shock | ΔR | 0.001% | |
| | ΔRatio | 0.001% | |
| Vibration, High Frequency | ΔR | 0.001% | |
| | ΔRatio | 0.001% | |
| Life | 0.3 W @ +125°C | ΔR 0.01% | |
| | 0.02 W @ +60°C | ΔR 0.003% | |
| | 0.05 W @ +25°C | ΔR | 0.001% |
| | | ΔRatio | 0.002% |
| High Temperature Exposure | ΔR | 0.01% | |
| | ΔRatio | 0.01% | |
| Low Temperature Storage | ΔR | 0.002% | |
| | ΔRatio | 0.002% | |
| Insulation Resistance | | > 500,000MΩ | |
| Dielectric Withstanding Voltage | | No Change | |
| Voltage Coefficient ⁽⁵⁾ | ΔR | < 0.1ppm/V ⁽⁵⁾ | |
| | ΔRatio | < 0.1ppm/V ⁽⁵⁾ | |
| Noise | N/A | - 40dB (non-measurable) | |
| Inductance | N/A | 0.08μH | |
| Capacitance | N/A | 0.5pf | |
| Rise Time | N/A | 1ns @ 1KΩ | |
| Thermal EMF lead to lead | N/A | 0.04μV/°C | |
| Thermal EMF air circulation | N/A | 0.02μV/°C | |
| Thermal EMF power | N/A | 0.1μV for 20mW | |
| Shelf Life | ΔR ⁽⁶⁾ | 25ppm/year | |
| | ΔRatio ⁽⁶⁾ | 10ppm/year | |

- (1) Typical is a designer's reference that represents 85% of production. Most of the ΔR's shown are maximums. To ensure that all typical values are maximums a "burn-in" is required.
- (2) ΔR: absolute resistance change.
- (3) ΔRatio: change in ratio between resistors within the network package from before to after the specified test.
- (4) Depending on construction and ratio value.
- (5) Measured < 0.1ppm/V and within the measurement capability of the equipment. Voltage coefficient is "essentially zero".
- (6) 2 ppm when in hermetically sealed package.

SALES

• ISRAEL: foilsales.israel@vishay.com • FRANCE/SWITZERLAND/SOUTHERN EUROPE: foilsales.eusouth@vishay.com • AMERICAS: foilsales.usa@vishay.com
 • ASIA/JAPAN: foilsales.asia@vishay.com • UK/HOLLAND/SCANDANAVIA: foilsales.eunorth@vishay.com • GERMANY/CZECH REPUBLIC/AUSTRIA: foilsales.eucentral@vishay.com



FIGURE 1 - VISHAY MODEL 300198 NETWORK

APPLICATION EXAMPLE

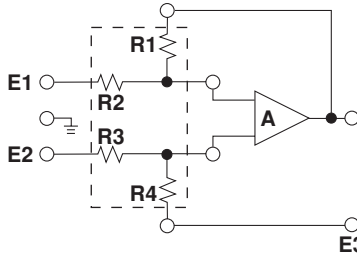

FIGURE 2 - POWER DERATING CURVE

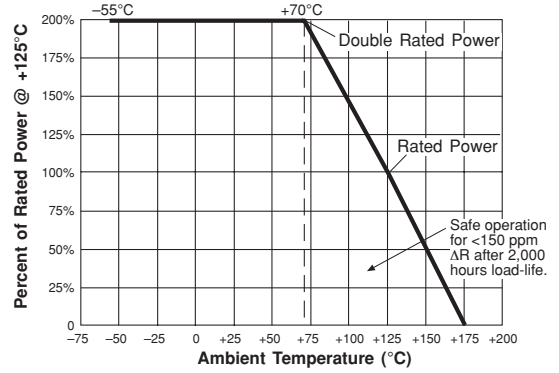
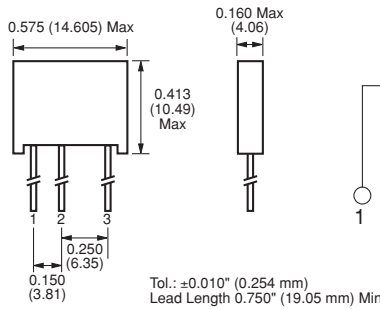
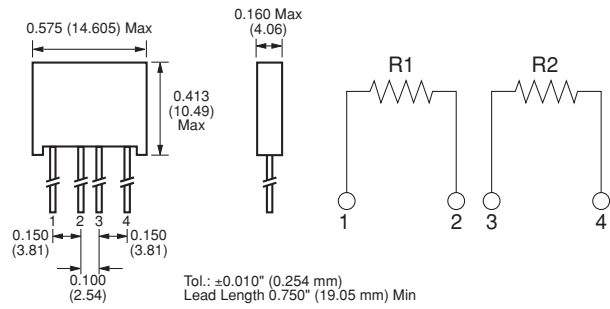

FIGURE 3 - MOLDED 2R, 3R, 4R RESISTOR NETWORK DIMENSIONS AND CIRCUIT DESIGN in inches (millimeters)

MODEL 300190



MODEL 300191



MODEL 300192

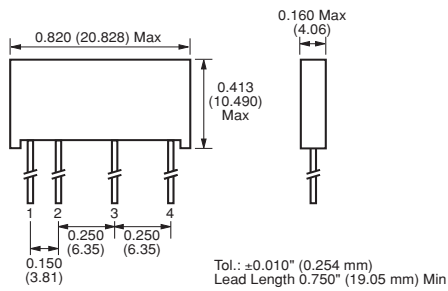

MODEL 300193

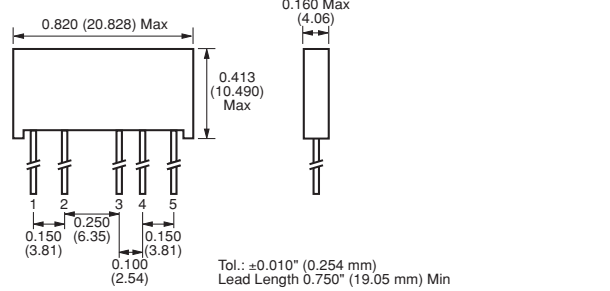

THROUGH HOLE

SALES

- ISRAEL: foilsales.israel@vishay.com
- FRANCE/SWITZERLAND/SOUTHERN EUROPE: foilsales.eusouth@vishay.com
- AMERICAS: foilsales.usa@vishay.com
- ASIA/JAPAN: foilsales.asia@vishay.com
- UK/HOLLAND/SCANDANAVIA: foilsales.eunorth@vishay.com
- GERMANY/CZECH REPUBLIC/AUSTRIA: foilsales.eucentral@vishay.com

FIGURE 4 - MOLDED 2R, 3R, 4R RESISTOR NETWORK DIMENSIONS AND CIRCUIT DESIGN in inches (millimeters)

MODEL 300194

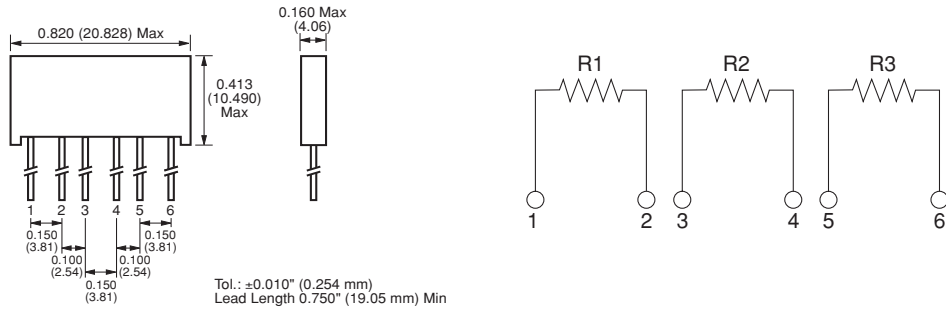

MODEL 300195

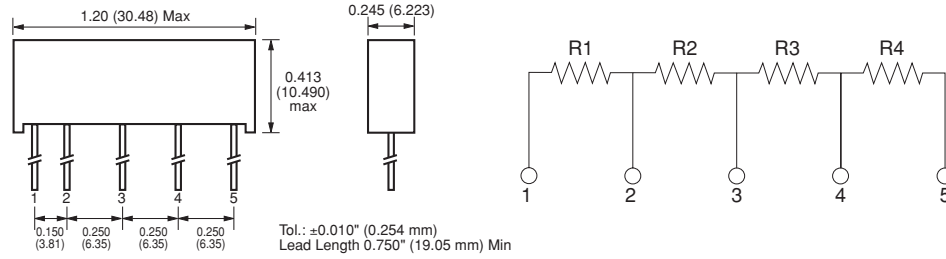

MODEL 300196

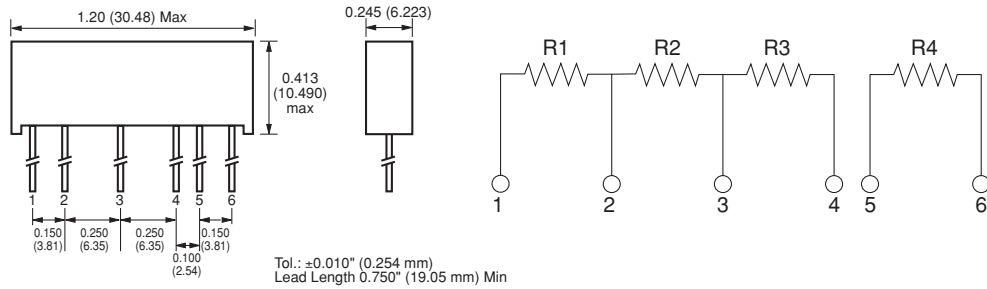

MODEL 300197

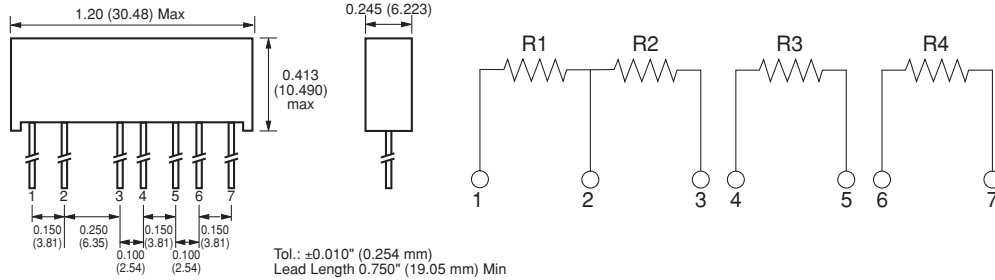

MODEL 300198

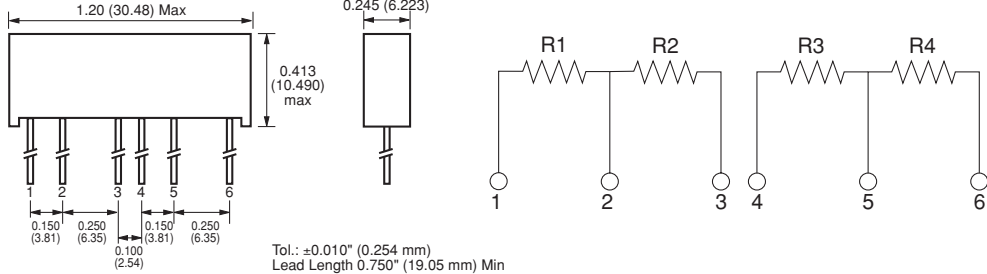

THROUGH HOLE

SALES

• ISRAEL: foilsales.israel@vishay.com • FRANCE/SWITZERLAND/SOUTHERN EUROPE: foilsales.eusouth@vishay.com • AMERICAS: foilsales.usa@vishay.com
• ASIA/JAPAN: foilsales.asia@vishay.com • UK/HOLLAND/SCANDANAVIA: foilsales.eunorth@vishay.com • GERMANY/CZECH REPUBLIC/AUSTRIA: foilsales.eucentral@vishay.com

FIGURE 5 - MOLDED 2R, 3R, 4R RESISTOR NETWORK DIMENSIONS AND CIRCUIT DESIGN in inches (millimeters)

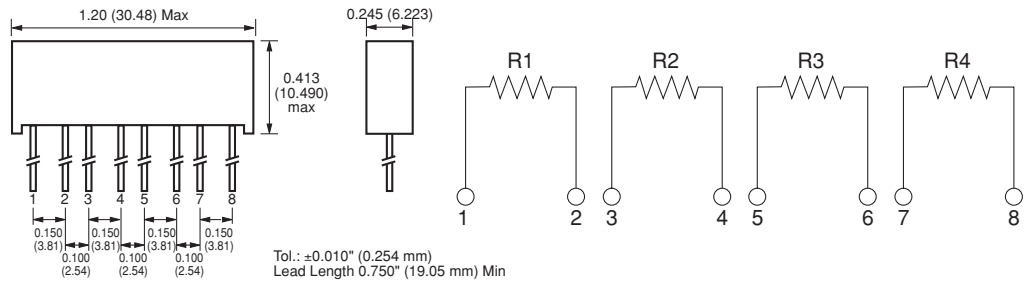
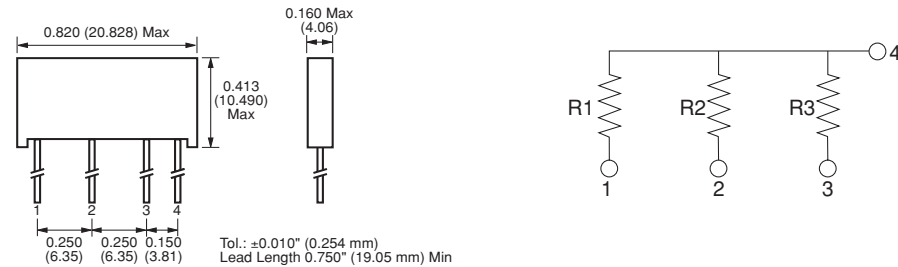
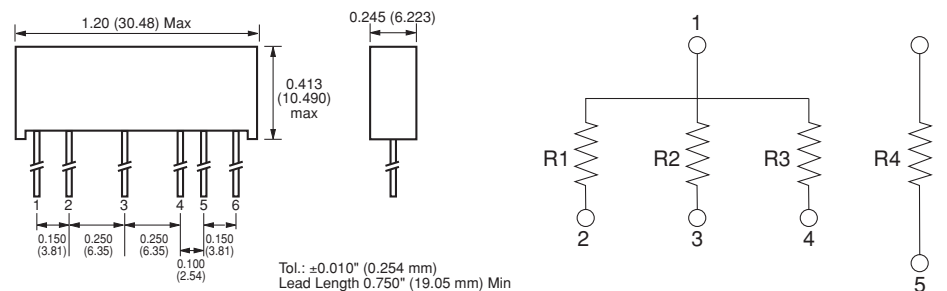
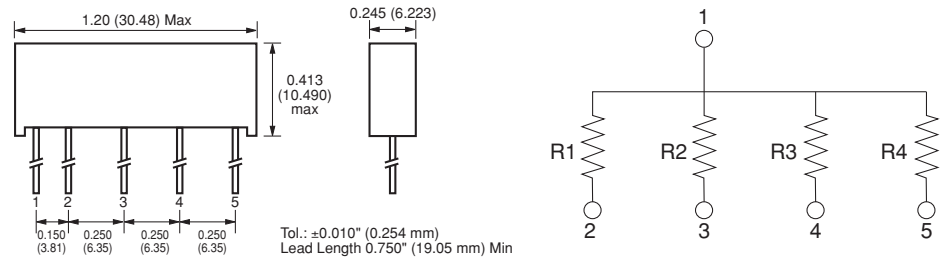
MODEL 300199

MODEL 300210

MODEL 300211

MODEL 300212

ORDERING INFORMATION - MOLDED 2R, 3R AND 4R RESISTOR NETWORKS

Networks are built to your requirements. Send your schematic and electrical requirements to the Applications Engineering Department. (See data sheet "Network Worksheet.") A unique part number will be assigned which defines all aspects of your network.

SALES

• ISRAEL: foilsales.israel@vishay.com • FRANCE/SWITZERLAND/SOUTHERN EUROPE: foilsales.eusouth@vishay.com • AMERICAS: foilsales.usa@vishay.com
 • ASIA/JAPAN: foilsales.asia@vishay.com • UK/HOLLAND/SCANDANAVIA: foilsales.eunorth@vishay.com • GERMANY/CZECH REPUBLIC/AUSTRIA: foilsales.eucentral@vishay.com

THROUGH HOLE