

RECTIFIER ASSEMBLIES

679, 680, 683, 684 SERIES

Single Phase Bridges, 10-25 Amp,
Standard and Fast Recovery Magnum™

FEATURES

- Current Ratings: to 25A
- Recovery Time: to 500ns
- PIVs: from 100 to 600V
- Surge Ratings: to 150A
- Only Fused-in-Glass Diodes Used
- Controlled Avalanche Characteristics
- Aluminum Heat Sink Case, Electrically Insulated

DESCRIPTION

This series of single phase MAGNUM™ bridge offers the designer the ultimate in high current power supply applications. The fast recovery series allows operation at full power at high frequencies, up to 40kHz square wave, which is often used in chopper, inverters and converters in aircraft, missiles, etc., equipment.

ABSOLUTE MAXIMUM RATINGS

| | |
|---|-------------------------------|
| Peak Inverse Voltage | 100 to 600V |
| Maximum Average D.C. Output Current | See Electrical Specifications |
| Non-Repetitive Sinusoidal Surge (8.3ms) | See Electrical Specifications |
| Operating and Storage Temperature Range, T _C | -65°C to +150°C |
| Thermal Resistance Junction to Ambient, 679, 683 Series | 20°C/W |
| Junction to Ambient, 680, 684 Series | 25°C/W |
| Junction to Case, 679, 683 Series | 2.0°C/W |
| Junction to Case, 680, 684 Series | 4.0°C/W |

MECHANICAL SPECIFICATIONS

680, 684 SERIES

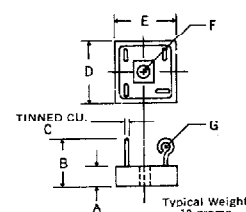

| | ins. | mm. |
|---|---------------|----------------|
| A | .250 MAX. | 6.10 MAX. |
| B | .57 MAX. | 14.45 MAX. |
| C | .040 TYP. | 1.02 TYP. |
| D | .750 MAX. | 19.05 MAX. |
| E | .750 MAX. | 19.05 MAX. |
| F | .140 DIA. | 3.56 DIA. |
| G | .09 DIA. TYP. | 2.29 DIA. TYP. |

Typical Weight — 0.35 ounces
10 grams

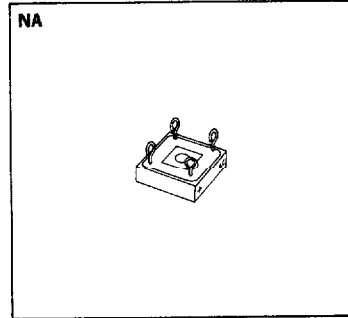

679, 683 SERIES

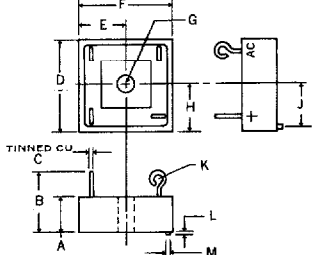

| | ins. | mm. |
|---|---------------|----------------|
| A | .328 MAX. | 8.33 MAX. |
| B | .750 MAX. | 19.05 MAX. |
| C | .040 TYP. | 1.02 TYP. |
| D | 1.125 MAX. | 28.58 MAX. |
| E | .562 | 14.27 |
| F | 1.125 MAX. | 28.58 MAX. |
| G | .193 | 4.90 |
| H | .562 | 14.27 |
| J | .500 | 12.70 |
| K | .09 DIA. TYP. | 2.29 DIA. TYP. |
| L | .062 | 1.57 |
| M | .062 | 1.57 |

Typical Weight — 0.7 ounces
20 grams

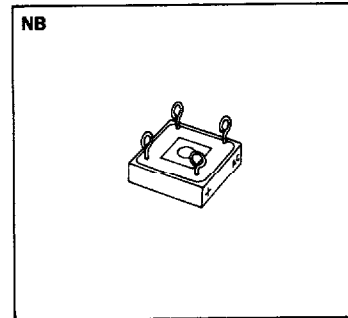

MARKING

| | |
|---------------------------|------|
| Alternating Current Input | A.C. |
| Cathode — Positive Output | + |
| Anode — Negative | - |

Part number is printed on the body.

Microsemi Corp.
Watertown
The diode experts

3

| Electrical Specifications (at 25°C unless noted) | | | | | | Maximum Ratings | | | |
|--|-------------|--------------------------------------|---------------------------------------|------------------------|--------------------------------|-------------------------------------|------------------------|---|-----|
| Type | PIV Per Leg | Maximum Forward Voltage Drop Per Leg | Maximum Leakage Current Per Leg @ PIV | | Maximum Reverse Recovery Time* | Maximum Average D.C. Output Current | | Non-Repetitive Sinusoidal Surge (8.3ms) | |
| | | | T _A = 25°C | T _A = 100°C | | T _C = 55°C | T _C = 100°C | | |
| | | | μA | μA | | Amps | Amps | | |
| Standard Recovery | 679-1 | 100 | 1.2V @ 10A | 10 | 200 | — | 25 | 18.5 | 150 |
| | 679-2 | 200 | | | | | | | |
| | 679-3 | 300 | | | | | | | |
| | 679-4 | 400 | | | | | | | |
| | 679-5 | 500 | | | | | | | |
| | 679-6 | 600 | | | | | | | |
| Standard Recovery | 680-1 | 100 | 1.2V @ 2A | 2 | 50 | — | 10 | 6 | 50 |
| | 680-2 | 200 | | | | | | | |
| | 680-3 | 300 | | | | | | | |
| | 680-4 | 400 | | | | | | | |
| | 680-5 | 500 | | | | | | | |
| | 680-6 | 600 | | | | | | | |
| Fast Recovery | 683-1 | 100 | 1.2V @ 6A | 10 | 200 | 500 | 20 | 14 | 150 |
| | 683-2 | 200 | | | | | | | |
| | 683-3 | 300 | | | | | | | |
| | 683-4 | 400 | | | | | | | |
| | 683-5 | 500 | | | | | | | |
| | 683-6 | 600 | | | | | | | |
| Fast Recovery | 684-1 | 100 | 1.2V @ 2A | 5 | 100 | 500 | 10 | 6 | 50 |
| | 684-2 | 200 | | | | | | | |
| | 684-3 | 300 | | | | | | | |
| | 684-4 | 400 | | | | | | | |
| | 684-5 | 500 | | | | | | | |
| | 684-6 | 600 | | | | | | | |

*Measured in a reverse recovery circuit switching from 1.0A forward to 1.0A reverse current recovering to 0.5A.

Typical Forward Voltage Per Leg vs. Forward Current

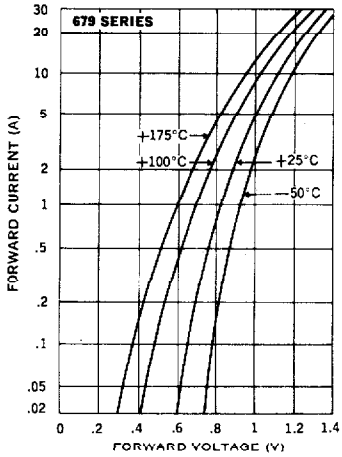

Typical Forward Voltage Per Leg vs. Forward Current

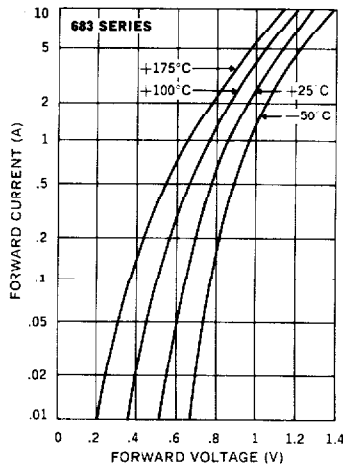

Typical Forward Voltage Per Leg vs. Forward Current

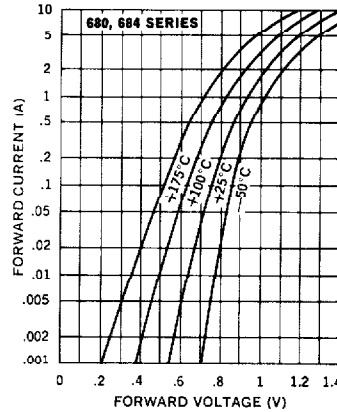

Typical Leakage Current vs. PIV

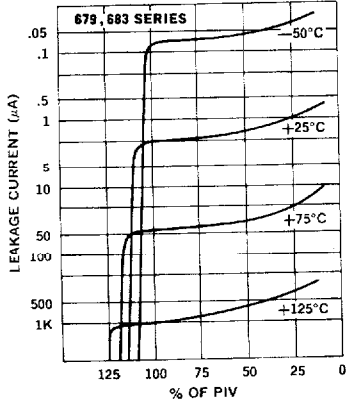

Typical Leakage Current vs. PIV

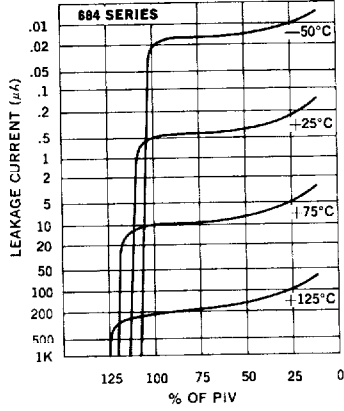

Typical Leakage Current vs. PIV

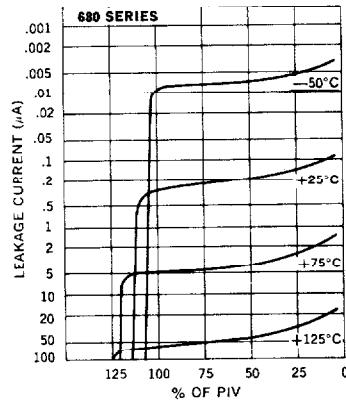

Reverse Recovery Circuit

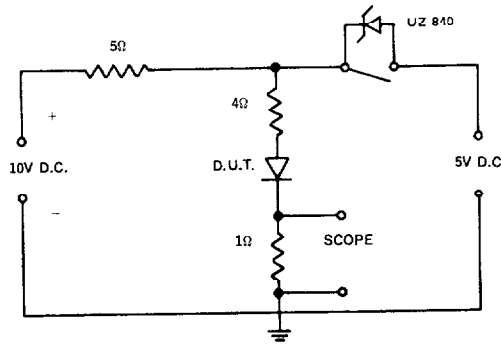

Current Derating Curve

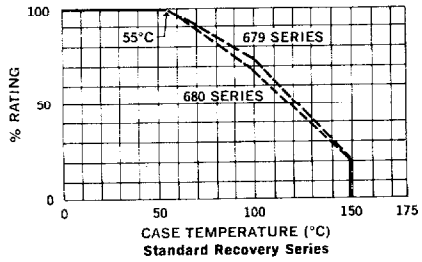

Current Derating Curve

