

74AHC1G126; 74AHCT1G126

Bus buffer/line driver; 3-state

Rev. 06 — 25 May 2007

Product data sheet

1. General description

74AHC1G126 and 74AHCT1G126 are high-speed Si-gate CMOS devices.

They provide one non-inverting buffer/line driver with 3-state output. The 3-state output is controlled by the output enable input pin (OE). A LOW at pin OE causes the output to assume a high-impedance OFF-state.

The AHC device has CMOS input switching levels and supply voltage range 2 V to 5.5 V.

The AHCT device has TTL input switching levels and supply voltage range 4.5 V to 5.5 V.

2. Features

- Symmetrical output impedance
- High noise immunity
- Low power dissipation
- Balanced propagation delays
- SOT353-1 and SOT753 package options
- ESD protection:
 - ◆ HBM JESD22-A114E: exceeds 2000 V
 - ◆ MM JESD22-A115-A: exceeds 200 V
 - ◆ CDM JESD22-C101C: exceeds 1000 V
- Specified from -40 °C to +125 °C

3. Ordering information

Table 1. Ordering information

Type number	Package			
	Temperature range	Name	Description	Version
74AHC1G126GW	-40 °C to +125 °C	TSSOP5	plastic thin shrink small outline package; 5 leads; body width 1.25 mm	SOT353-1
74AHCT1G126GW				
74AHC1G126GV	-40 °C to +125 °C	SC-74A	plastic surface-mounted package; 5 leads	SOT753
74AHCT1G126GV				

4. Marking

Table 2. Marking codes

Type number	Marking
74AHC1G126GW	AN
74AHC1G126GV	A26
74AHCT1G126GW	CN
74AHCT1G126GV	C26

5. Functional diagram

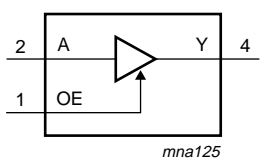

Fig 1. Logic symbol

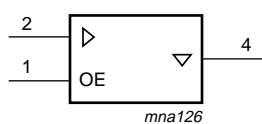

Fig 2. IEC logic symbol

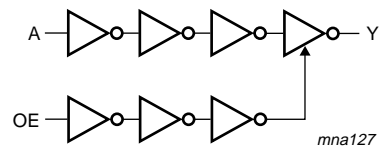
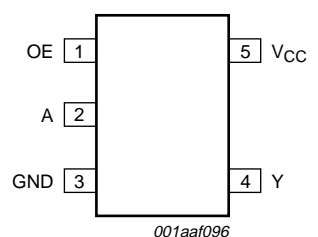

Fig 3. Logic diagram

6. Pinning information

6.1 Pinning

74AHC1G126
74AHCT1G126



001aaf096

Fig 4. Pin configuration

6.2 Pin description

Table 3. Pin description

Symbol	Pin	Description
OE	1	output enable input
A	2	data input A
GND	3	ground (0 V)
Y	4	data output Y
V _{CC}	5	supply voltage

7. Functional description

Table 4. Function table

H = HIGH voltage level; L = LOW voltage level; X = don't care; Z = high-impedance OFF-state

Input		Output
OE	A	Y
H	L	L
H	H	H
L	X	Z

8. Limiting values

Table 5. Limiting values

In accordance with the Absolute Maximum Rating System (IEC 60134). Voltages are referenced to GND (ground = 0 V).

Symbol	Parameter	Conditions	Min	Max	Unit
V _{CC}	supply voltage		-0.5	+7.0	V
V _I	input voltage		-0.5	+7.0	V
I _{IK}	input clamping current	V _I < -0.5 V	-20	-	mA
I _{OK}	output clamping current	V _O < -0.5 V or V _O > V _{CC} + 0.5 V	[1] -	±20	mA
I _O	output current	-0.5 V < V _O < V _{CC} + 0.5 V	-	±25	mA
I _{CC}	supply current		-	75	mA
I _{GND}	ground current		-75	-	mA
T _{stg}	storage temperature		-65	+150	°C
P _{tot}	total power dissipation	T _{amb} = -40 °C to +125 °C	[2] -	250	mW

[1] The input and output voltage ratings may be exceeded if the input and output current ratings are observed.

[2] For both TSSOP5 and SC-74A packages: above 87.5 °C the value of P_{tot} derates linearly with 4.0 mW/K.

9. Recommended operating conditions

Table 6. Recommended operating conditions

Voltages are referenced to GND (ground = 0 V).

Symbol	Parameter	Conditions	74AHC1G126			74AHCT1G126			Unit
			Min	Typ	Max	Min	Typ	Max	
V _{CC}	supply voltage		2.0	5.0	5.5	4.5	5.0	5.5	V
V _I	input voltage		0	-	5.5	0	-	5.5	V
V _O	output voltage		0	-	V _{CC}	0	-	V _{CC}	V
T _{amb}	ambient temperature		-40	+25	+125	-40	+25	+125	°C
Δt/ΔV	input transition rise and fall rate	V _{CC} = 3.3 V ± 0.3 V	-	-	100	-	-	-	ns/V
		V _{CC} = 5.0 V ± 0.5 V	-	-	20	-	-	20	ns/V

10. Static characteristics

Table 7. Static characteristics

Voltages are referenced to GND (ground = 0 V).

Symbol	Parameter	Conditions	25 °C			-40 °C to +85 °C		-40 °C to +125 °C		Unit
			Min	Typ	Max	Min	Max	Min	Max	
For type 74AHC1G126										
V _{IH}	HIGH-level input voltage	V _{CC} = 2.0 V	1.5	-	-	1.5	-	1.5	-	V
		V _{CC} = 3.0 V	2.1	-	-	2.1	-	2.1	-	V
		V _{CC} = 5.5 V	3.85	-	-	3.85	-	3.85	-	V
V _{IL}	LOW-level input voltage	V _{CC} = 2.0 V	-	-	0.5	-	0.5	-	0.5	V
		V _{CC} = 3.0 V	-	-	0.9	-	0.9	-	0.9	V
		V _{CC} = 5.5 V	-	-	1.65	-	1.65	-	1.65	V
V _{OH}	HIGH-level output voltage	V _I = V _{IH} or V _{IL}								
		I _O = -50 μA; V _{CC} = 2.0 V	1.9	2.0	-	1.9	-	1.9	-	V
		I _O = -50 μA; V _{CC} = 3.0 V	2.9	3.0	-	2.9	-	2.9	-	V
		I _O = -50 μA; V _{CC} = 4.5 V	4.4	4.5	-	4.4	-	4.4	-	V
		I _O = -4.0 mA; V _{CC} = 3.0 V	2.58	-	-	2.48	-	2.40	-	V
		I _O = -8.0 mA; V _{CC} = 4.5 V	3.94	-	-	3.8	-	3.70	-	V
V _{OL}	LOW-level output voltage	V _I = V _{IH} or V _{IL}								
		I _O = 50 μA; V _{CC} = 2.0 V	-	0	0.1	-	0.1	-	0.1	V
		I _O = 50 μA; V _{CC} = 3.0 V	-	0	0.1	-	0.1	-	0.1	V
		I _O = 50 μA; V _{CC} = 4.5 V	-	0	0.1	-	0.1	-	0.1	V
		I _O = 4.0 mA; V _{CC} = 3.0 V	-	-	0.36	-	0.44	-	0.55	V
		I _O = 8.0 mA; V _{CC} = 4.5 V	-	-	0.36	-	0.44	-	0.55	V
I _{OZ}	OFF-state output current	V _I = V _{IH} or V _{IL} ; V _O = V _{CC} or GND; V _{CC} = 5.5 V	-	-	±0.25	-	±2.5	-	±10	μA
I _I	input leakage current	V _I = 5.5 V or GND; V _{CC} = 0 V to 5.5 V	-	-	0.1	-	1.0	-	2.0	μA
I _{CC}	supply current	V _I = V _{CC} or GND; I _O = 0 A; V _{CC} = 5.5 V	-	-	2.0	-	20	-	40	μA
C _I	input capacitance		-	3	10	-	10	-	10	pF
For type 74AHCT1G126										
V _{IH}	HIGH-level input voltage	V _{CC} = 4.5 V to 5.5 V	2.0	-	-	2.0	-	2.0	-	V
V _{IL}	LOW-level input voltage	V _{CC} = 4.5 V to 5.5 V	-	-	0.8	-	0.8	-	0.8	V
V _{OH}	HIGH-level output voltage	V _I = V _{IH} or V _{IL} ; V _{CC} = 4.5 V								
		I _O = -50 μA	4.4	4.5	-	4.4	-	4.4	-	V
		I _O = -8.0 mA	3.94	-	-	3.8	-	3.70	-	V
V _{OL}	LOW-level output voltage	V _I = V _{IH} or V _{IL} ; V _{CC} = 4.5 V								
		I _O = 50 μA	-	0	0.1	-	0.1	-	0.1	V
		I _O = 8.0 mA	-	-	0.36	-	0.44	-	0.55	V

Table 7. Static characteristics ...continued
 Voltages are referenced to GND (ground = 0 V).

Symbol	Parameter	Conditions	25 °C			-40 °C to +85 °C		-40 °C to +125 °C		Unit
			Min	Typ	Max	Min	Max	Min	Max	
I_{OZ}	OFF-state output current	$V_I = V_{IH}$ or V_{IL} ; $V_O = V_{CC}$ or GND; $V_{CC} = 5.5$ V	-	-	±0.25	-	±2.5	-	±10	µA
I_I	input leakage current	$V_I = 5.5$ V or GND; $V_{CC} = 0$ V to 5.5 V	-	-	0.1	-	1.0	-	2.0	µA
I_{CC}	supply current	$V_I = V_{CC}$ or GND; $I_O = 0$ A; $V_{CC} = 5.5$ V	-	-	2.0	-	20	-	40	µA
ΔI_{CC}	additional supply current	per input pin; $V_I = V_{CC} - 2.1$ V; other inputs at V_{CC} or GND; $I_O = 0$ A; $V_{CC} = 4.5$ V to 5.5 V	-	-	1.35	-	1.5	-	1.5	mA
C_I	input capacitance		-	3	10	-	10	-	10	pF

11. Dynamic characteristics

Table 8. Dynamic characteristics
 $GND = 0$ V; $t_r = t_f = \leq 3.0$ ns. For test circuit see [Figure 7](#).

Symbol	Parameter	Conditions	25 °C			-40 °C to +85 °C		-40 °C to +125 °C		Unit
			Min	Typ	Max	Min	Max	Min	Max	

For type 74AHC1G126

t_{pd}	propagation delay	A to Y; see Figure 5 [1]								
		$V_{CC} = 3.0$ V to 3.6 V [2]								
		$C_L = 15$ pF	-	4.4	8.0	1.0	9.5	1.0	10.0	ns
		$C_L = 50$ pF	-	6.3	11.5	1.0	13.0	1.0	14.5	ns
		$V_{CC} = 4.5$ V to 5.5 V [3]								
		$C_L = 15$ pF	-	3.4	5.5	1.0	6.5	1.0	7.0	ns
t_{en}	enable time	OE to Y; see Figure 6 [1]								
		$V_{CC} = 3.0$ V to 3.6 V [2]								
		$C_L = 15$ pF	-	4.9	8.0	1.0	9.5	1.0	10.0	ns
		$C_L = 50$ pF	-	7.0	11.5	1.0	13.0	1.0	14.5	ns
		$V_{CC} = 4.5$ V to 5.5 V [3]								
		$C_L = 15$ pF	-	3.6	5.6	1.0	6.3	1.0	7.0	ns
t_{dis}	disable time	OE to Y; see Figure 6 [1]								
		$V_{CC} = 3.0$ V to 3.6 V [2]								
		$C_L = 15$ pF	-	6.3	9.7	1.0	11.5	1.0	12.5	ns
		$C_L = 50$ pF	-	9.0	13.2	1.0	15.0	1.0	16.5	ns
		$V_{CC} = 4.5$ V to 5.5 V [3]								
		$C_L = 15$ pF	-	4.3	6.8	1.0	8.0	1.0	8.5	ns
		$C_L = 50$ pF	-	6.1	8.8	1.0	10.0	1.0	11.0	ns

Table 8. Dynamic characteristics ...continued
GND = 0 V; $t_r = t_f \leq 3.0$ ns. For test circuit see Figure 7.

Symbol	Parameter	Conditions	25 °C			-40 °C to +85 °C		-40 °C to +125 °C		Unit	
			Min	Typ	Max	Min	Max	Min	Max		
C_{PD}	power dissipation capacitance	per buffer; $C_L = 50$ pF; $f = 1$ MHz; $V_I = GND$ to V_{CC}	[4]	-	9	-	-	-	-	pF	
For type 74AHCT1G126											
t_{pd}	propagation delay	A to Y; see Figure 5	[1]								
		$V_{CC} = 4.5$ V to 5.5 V	[3]								
		$C_L = 15$ pF		-	3.4	5.5	1.0	6.5	1.0	7.0	ns
		$C_L = 50$ pF		-	4.7	7.5	1.0	8.5	1.0	9.5	ns
t_{en}	enable time	\overline{OE} to Y; see Figure 6	[1]								
		$V_{CC} = 4.5$ V to 5.5 V	[3]								
		$C_L = 15$ pF		-	3.4	5.6	1.0	6.3	1.0	6.5	ns
		$C_L = 50$ pF		-	4.8	8.0	1.0	9.0	1.0	9.0	ns
t_{dis}	disable time	\overline{OE} to Y; see Figure 6	[1]								
		$V_{CC} = 4.5$ V to 5.5 V	[3]								
		$C_L = 15$ pF			4.0	6.8	1.0	8.0	1.0	8.5	ns
		$C_L = 50$ pF			5.7	8.8	1.0	10.0	1.0	11.5	ns
C_{PD}	power dissipation capacitance	per buffer; $C_L = 50$ pF; $f = 1$ MHz; $V_I = GND$ to V_{CC}	[4]	-	11	-	-	-	-	pF	

- [1] t_{pd} is the same as t_{PLH} and t_{PHL} .
 t_{en} is the same as t_{PZL} and t_{PZH} .
 t_{dis} is the same as t_{PLZ} and t_{PHZ} .
- [2] Typical values are measured at $V_{CC} = 3.3$ V.
- [3] Typical values are measured at $V_{CC} = 5.0$ V.
- [4] C_{PD} is used to determine the dynamic power dissipation P_D (μ W).
 $P_D = C_{PD} \times V_{CC}^2 \times f_i + \sum (C_L \times V_{CC}^2 \times f_o)$ where:
 f_i = input frequency in MHz;
 f_o = output frequency in MHz;
 C_L = output load capacitance in pF;
 V_{CC} = supply voltage in Volts.

12. Waveforms

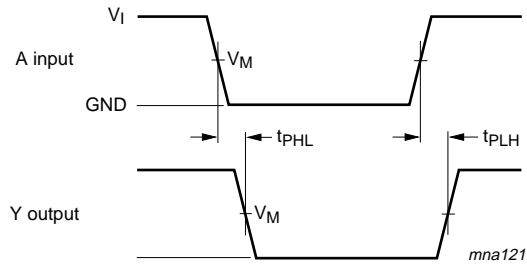

Measurement points are given in [Table 9](#).

Fig 5. The clock (A) to output (Y) propagation delays

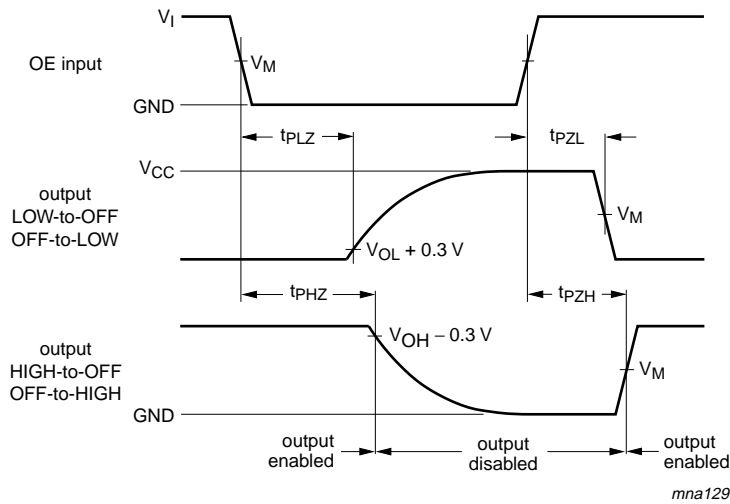

Measurement points are given in [Table 9](#).

Fig 6. The 3-state enable and disable times

Table 9. Measurement points

Type	Input		Output
	V_M	V_I	V_M
74AHC1G126	$0.5 \times V_{CC}$	GND to V_{CC}	$0.5 \times V_{CC}$
74AHCT1G126	1.5 V	GND to 3.0 V	$0.5 \times V_{CC}$

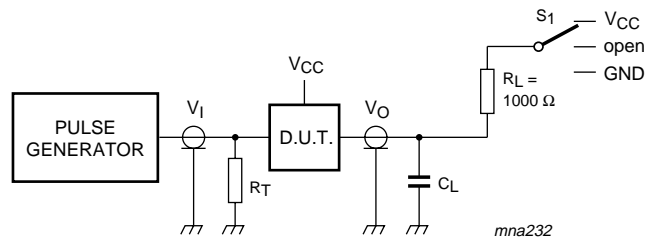

For test data see [Table 8](#). Definitions for test circuit:

C_L = Load capacitance including jig and probe capacitance.

R_L = Load resistance.

R_T = Termination resistance should be equal to output impedance Z_o of the pulse generator.

For t_{PLH} , t_{PHL} , S_1 = open

For t_{PLZ} , t_{PZL} , S_1 = V_{CC}

For t_{PHZ} , t_{PZH} , S_1 = GND

Fig 7. Load circuitry for switching times

13. Package outline

TSSOP5: plastic thin shrink small outline package; 5 leads; body width 1.25 mm

SOT353-1



Fig 8. Package outline SOT353-1 (TSSOP5)

Plastic surface-mounted package; 5 leads

SOT753

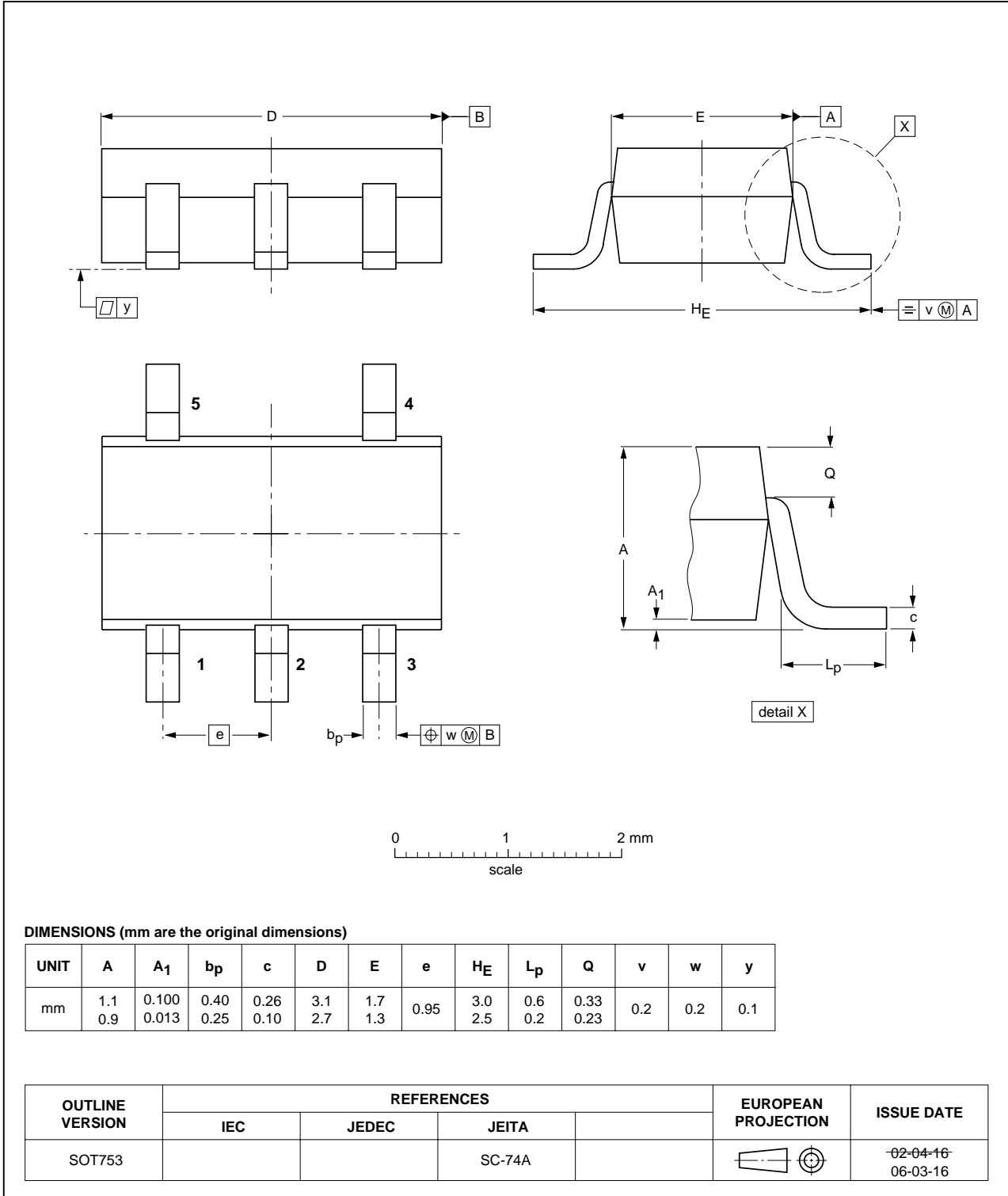

Fig 9. Package outline SOT753 (SC-74A)

14. Abbreviations

Table 10. Abbreviations

Acronym	Description
CDM	Charged Device Model
DUT	Device Under Test
ESD	ElectroStatic Discharge
HBM	Human Body Model
MM	Machine Model
TTL	Transistor-Transistor Logic

15. Revision history

Table 11. Revision history

Document ID	Release date	Data sheet status	Change notice	Supersedes
74AHC_AHCT1G126_6	20070525	Product data sheet	-	74AHC_AHCT1G126_5
Modifications:	<ul style="list-style-type: none"> • Typos in ordering numbers corrected in Table 1 "Ordering information". 			
74AHC_AHCT1G126_5	20070514	Product data sheet	-	74AHC_AHCT1G126_4
Modifications:	<ul style="list-style-type: none"> • Package SOT353 changed to SOT353-1 in Section 3 and Section 13. • Quick reference data and Soldering sections removed. • Section 2 "Features" updated. • The format of this data sheet has been redesigned to comply with the new identity guidelines of NXP Semiconductors. • Legal texts have been adapted to the new company name where appropriate. 			
74AHC_AHCT1G126_4	20020606	Product specification	-	74AHC_AHCT1G126_3
74AHC_AHCT1G126_3	20020215	Product specification	-	74AHC_AHCT1G126_2
74AHC_AHCT1G126_2	20010406	Product specification	-	74AHC1G_AHCT1G126_1
74AHC1G_AHCT1G126_1	19990920	Product specification	-	-

16. Legal information

16.1 Data sheet status

Document status ^{[1][2]}	Product status ^[3]	Definition
Objective [short] data sheet	Development	This document contains data from the objective specification for product development.
Preliminary [short] data sheet	Qualification	This document contains data from the preliminary specification.
Product [short] data sheet	Production	This document contains the product specification.

[1] Please consult the most recently issued document before initiating or completing a design.

[2] The term 'short data sheet' is explained in section "Definitions".

[3] The product status of device(s) described in this document may have changed since this document was published and may differ in case of multiple devices. The latest product status information is available on the Internet at URL <http://www.nxp.com>.

16.2 Definitions

Draft — The document is a draft version only. The content is still under internal review and subject to formal approval, which may result in modifications or additions. NXP Semiconductors does not give any representations or warranties as to the accuracy or completeness of information included herein and shall have no liability for the consequences of use of such information.

Short data sheet — A short data sheet is an extract from a full data sheet with the same product type number(s) and title. A short data sheet is intended for quick reference only and should not be relied upon to contain detailed and full information. For detailed and full information see the relevant full data sheet, which is available on request via the local NXP Semiconductors sales office. In case of any inconsistency or conflict with the short data sheet, the full data sheet shall prevail.

16.3 Disclaimers

General — Information in this document is believed to be accurate and reliable. However, NXP Semiconductors does not give any representations or warranties, expressed or implied, as to the accuracy or completeness of such information and shall have no liability for the consequences of use of such information.

Right to make changes — NXP Semiconductors reserves the right to make changes to information published in this document, including without limitation specifications and product descriptions, at any time and without notice. This document supersedes and replaces all information supplied prior to the publication hereof.

Suitability for use — NXP Semiconductors products are not designed, authorized or warranted to be suitable for use in medical, military, aircraft, space or life support equipment, nor in applications where failure or

malfunction of a NXP Semiconductors product can reasonably be expected to result in personal injury, death or severe property or environmental damage. NXP Semiconductors accepts no liability for inclusion and/or use of NXP Semiconductors products in such equipment or applications and therefore such inclusion and/or use is at the customer's own risk.

Applications — Applications that are described herein for any of these products are for illustrative purposes only. NXP Semiconductors makes no representation or warranty that such applications will be suitable for the specified use without further testing or modification.

Limiting values — Stress above one or more limiting values (as defined in the Absolute Maximum Ratings System of IEC 60134) may cause permanent damage to the device. Limiting values are stress ratings only and operation of the device at these or any other conditions above those given in the Characteristics sections of this document is not implied. Exposure to limiting values for extended periods may affect device reliability.

Terms and conditions of sale — NXP Semiconductors products are sold subject to the general terms and conditions of commercial sale, as published at <http://www.nxp.com/profile/terms>, including those pertaining to warranty, intellectual property rights infringement and limitation of liability, unless explicitly otherwise agreed to in writing by NXP Semiconductors. In case of any inconsistency or conflict between information in this document and such terms and conditions, the latter will prevail.

No offer to sell or license — Nothing in this document may be interpreted or construed as an offer to sell products that is open for acceptance or the grant, conveyance or implication of any license under any copyrights, patents or other industrial or intellectual property rights.

16.4 Trademarks

Notice: All referenced brands, product names, service names and trademarks are the property of their respective owners.

17. Contact information

For additional information, please visit: <http://www.nxp.com>

For sales office addresses, send an email to: salesaddresses@nxp.com

18. Contents

1	General description	1
2	Features	1
3	Ordering information	1
4	Marking	2
5	Functional diagram	2
6	Pinning information	2
6.1	Pinning	2
6.2	Pin description	2
7	Functional description	3
8	Limiting values	3
9	Recommended operating conditions	3
10	Static characteristics	4
11	Dynamic characteristics	5
12	Waveforms	7
13	Package outline	9
14	Abbreviations	11
15	Revision history	11
16	Legal information	12
16.1	Data sheet status	12
16.2	Definitions	12
16.3	Disclaimers	12
16.4	Trademarks	12
17	Contact information	12
18	Contents	13

Please be aware that important notices concerning this document and the product(s) described herein, have been included in section 'Legal information'.



© NXP B.V. 2007.

All rights reserved.

For more information, please visit: <http://www.nxp.com>

For sales office addresses, please send an email to: salesaddresses@nxp.com

Date of release: 25 May 2007

Document identifier: 74AHC_AHCT1G126_6