

74F1071 18-Bit Undershoot/Overshoot Clamp and ESD Protection Device

General Description

The 74F1071 is an 18-bit undershoot/overshoot clamp which is designed to limit bus voltages and also to protect more sensitive devices from electrical overstress due to electrostatic discharge (ESD). The inputs of the device aggressively clamp voltage excursions nominally at 0.5V below and 7V above ground.

Features

- 18-bit array structure in 20-pin package
- FAST® Bipolar voltage clamping action
- Dual center pin grounds for min inductance
- Robust design for ESD protection
- Low input capacitance
- Optimum voltage clamping for 5V CMOS/TTL applications

Ordering Code:

Order Number	Package Number	Package Description
74F1071SC	M20B	20-Lead Small Outline Integrated Circuit (SOIC), JEDEC MS-013, 0.300" Wide
74F1071SCX_NL (Note 1)	M20B	Pb-Free 20-Lead Small Outline Integrated Circuit (SOIC), JEDEC MS-013, 0.300" Wide
74F1071MSA	MSA20	20-Lead Shrink Small Outline Package (SSOP), JEDEC MO-150, 5.3mm Wide
74F1071MSAX_NL (Note 1)	MSA20	Pb-Free 20-Lead Shrink Small Outline Package (SSOP), JEDEC MO-150, 5.3mm Wide
74F1071MTC	MTC20	20-Lead Thin Shrink Small Outline Package (TSSOP), JEDEC MO-153, 4.4mm Wide
74F1071MTCX_NL (Note 1)	MTC20	Pb-Free 20-Lead Thin Shrink Small Outline Package (TSSOP), JEDEC MO-153, 4.4mm Wide

Devices also available in Tape and Reel. Specify by appending the suffix letter "X" to the ordering code.

Note 1: "_NL" indicates Pb-Free package (per JEDEC J-STD-020B). Device available in Tape and Reel only.

Connection Diagram

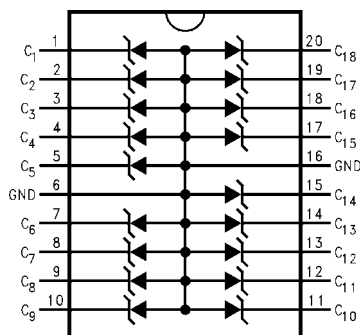

Note: Simplified Component Representation

FAST® is a registered trademark of Fairchild Semiconductor Corporation.

Absolute Maximum Ratings (Note 2)

Storage Temperature	-65°C to +150°C
Ambient Temperature under Bias	-65°C to +125°C
Junction Temperature under Bias	-65°C to +150°C
Input Voltage (Note 3)	-0.5V to +6V
Input Current (Note 3)	-200 mA to +50 mA
ESD (Note 4)	
Human Body Model (MIL-STD-883D method 3015.7)	±10 kV
IEC 801-2	±6 kV
Machine Model (EIAJIC-121-1981)	±2 kV
DC Latchup Source Current (JEDEC Method 17)	±500 mA
Package Power Dissipation @+70°C	
SOIC Package	800 mW

Recommended Operating Conditions

Free Air Ambient Temperature	0°C to +70°C
Reverse Bias Voltage	0V to 5.25 V _{DC}
Thermal Resistance (θ_{JA} in Free Air)	
SOIC Package	100°C/W
SSOP Package	110°C/W

Note 2: Absolute maximum ratings are DC values beyond which the device may be damaged or have its useful life impaired. Functional operation under these conditions is not implied.

Note 3: Voltage ratings may be exceeded if current ratings and junction temperature and power consumption ratings are not exceeded.

Note 4: ESD Rating for Direct contact discharge using ESD Simulation Tester. Higher rating may be realized in the actual application.

DC Electrical Characteristics

Symbol	Parameter	T _A = +25°C			T _A = 0°C to +70°C		Units	Conditions
		Min	Typ	Max	Min	Max		
I _{IH}	Input HIGH Current		1.5	10		50	μA	V _{IN} = 5.25V; Untested Input @ GND
			3	20		100		V _{IN} = 5.5V; Untested Input @ GND
V _Z	Reverse Voltage	6.6	6.9	7.2	5.9	7.7	V	I _Z = 1 mA; Untested Inputs @ GND
			7.1	7.5		8.0		I _Z = 50 mA; Untested Inputs @ GND
V _F	Forward Voltage	-0.3	-0.6	-0.9	-0.3	-0.9	V	I _F = -18 mA; Untested Inputs @ 5V
		-0.5	-1.1	-1.5	-0.5	-1.5		I _F = -200 mA; Untested Inputs @ 5V
I _{CT}	Adjacent Input Crosstalk			3			%	
C _{IN}	Input Capacitance		25				pF	V _{BIAS} = 0 V _{DC}
	(small signal @ 1 MHz)		13					V _{BIAS} = 5 V _{DC}

DC Electrical Characteristics

Typical Forward and Reverse V/I Characteristics

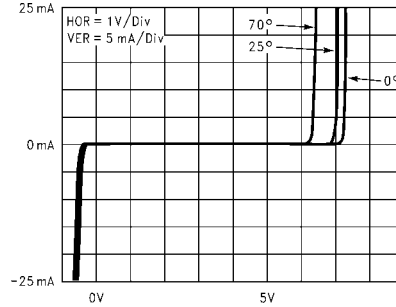

Typical Reverse Conduction Characteristics

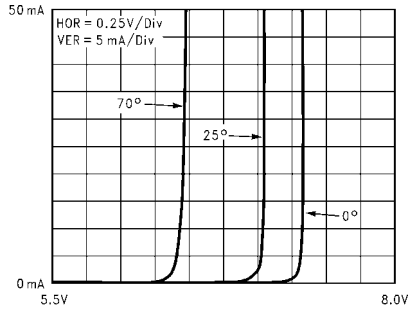

Typical Forward Conduction Characteristics

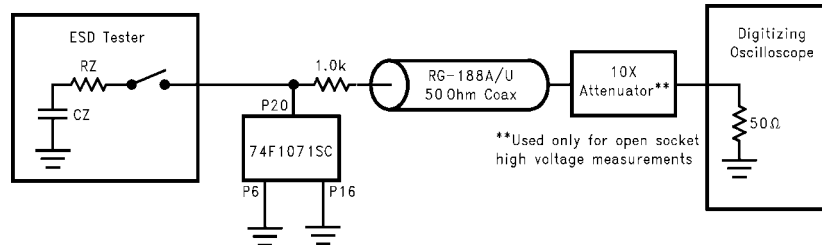
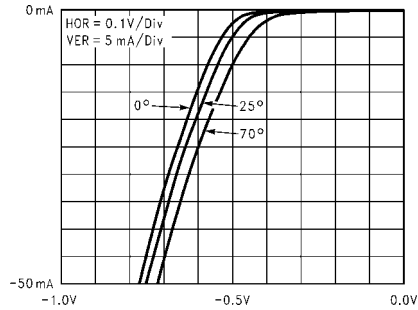

ESD Network	CZ	RZ
Human Body Model	100 pF	1500Ω
IEC 801-2	150 pF	330Ω

Simulated ESD Voltage Clamping Test Circuit

DC Electrical Characteristics (Continued)

Unclamped + 1 KV ESD Voltage Waveform (IEC801-2 Network)

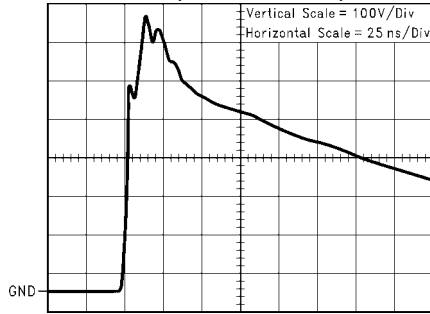

Clamped + 1 KV ESD Voltage Waveform (IEC801-2 Network)

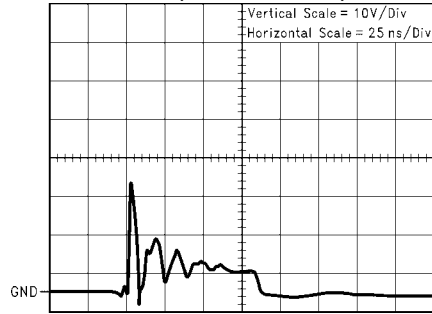

Unclamped - 1 KV ESD Voltage Waveform (IEC801-2 Network)

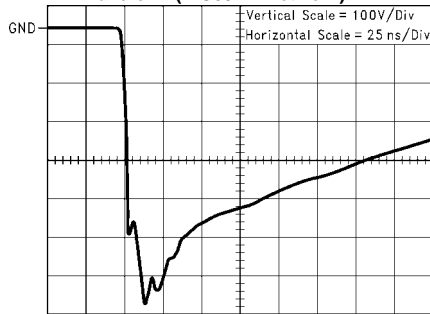

Clamped - 1 KV ESD Voltage Waveform (IEC801-2 Network)

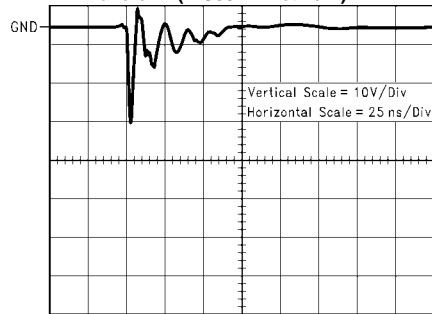

Typical Application

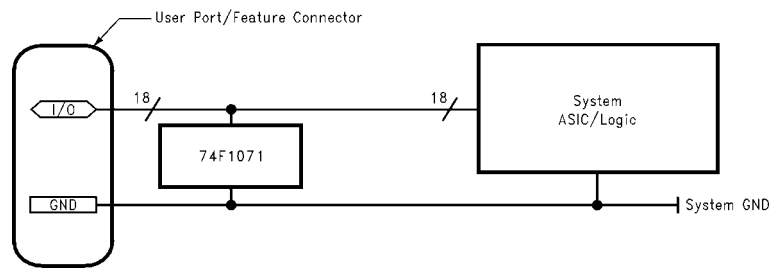

74F1071 ESD Protection of ASIC on User Port

Physical Dimensions inches (millimeters) unless otherwise noted



**20-Lead Small Outline Integrated Circuit (SOIC), JEDEC MS-013, 0.300" Wide
Package Number M20B**

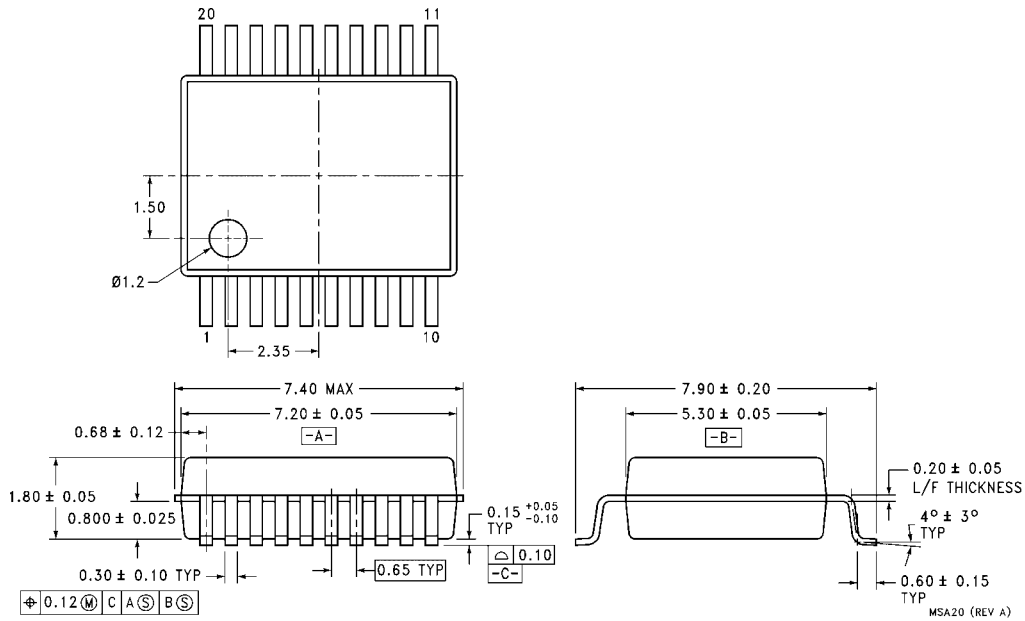

**20-Lead Shrink Small Outline Package (SSOP), JEDEC MO-150, 5.3mm Wide
Package Number MSA20**

Physical Dimensions inches (millimeters) unless otherwise noted (Continued)

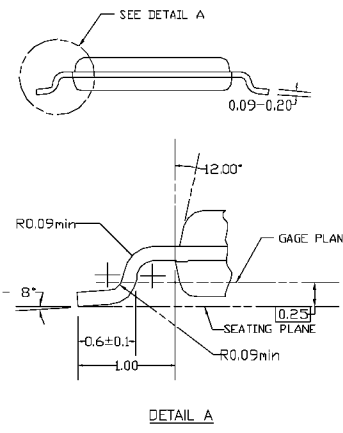
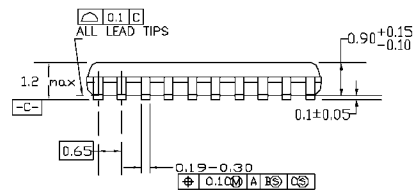
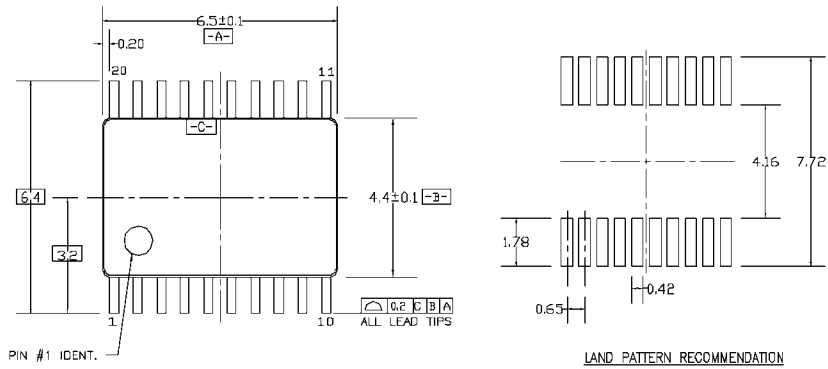

DIMENSIONS ARE IN MILLIMETERS

- NOTES:
- A. CONFORMS TO JEDEC REGISTRATION MO-153, VARIATION AC, REF NOTE 6, DATE 7/93.
 - B. DIMENSIONS ARE IN MILLIMETERS.
 - C. DIMENSIONS ARE EXCLUSIVE OF BURRS, MOLDS FLASH, AND TIE BAR EXTRUSIONS.
 - D. DIMENSIONS AND TOLERANCES PER ANSI Y14.5M, 1982.

MTC20REV D1

20-Lead Thin Shrink Small Outline Package (TSSOP), JEDEC MO-153, 4.4mm Wide Package Number MTC20

Fairchild does not assume any responsibility for use of any circuitry described, no circuit patent licenses are implied and Fairchild reserves the right at any time without notice to change said circuitry and specifications.

LIFE SUPPORT POLICY

FAIRCHILD'S PRODUCTS ARE NOT AUTHORIZED FOR USE AS CRITICAL COMPONENTS IN LIFE SUPPORT DEVICES OR SYSTEMS WITHOUT THE EXPRESS WRITTEN APPROVAL OF THE PRESIDENT OF FAIRCHILD SEMICONDUCTOR CORPORATION. As used herein:

1. Life support devices or systems are devices or systems which, (a) are intended for surgical implant into the body, or (b) support or sustain life, and (c) whose failure to perform when properly used in accordance with instructions for use provided in the labeling, can be reasonably expected to result in a significant injury to the user.
2. A critical component in any component of a life support device or system whose failure to perform can be reasonably expected to cause the failure of the life support device or system, or to affect its safety or effectiveness.

www.fairchildsemi.com