

SPECIFICATION

Device Name : IGBT Module

Type Name : 7MBR15SA060D-01

Spec. No. : MS6M 0541

Date : Jun. - 02 - 2000

This material and the information herein is the property of Fuji Electric Co., Ltd. They shall be neither reproduced, copied, lent, or disclosed in any way whatsoever for the use of any third party, nor used for the manufacturing purposes without the express written consent of Fuji Electric Co., Ltd.

Fuji Electric Co., Ltd.
Matsumoto Factory

	DATE	NAME	APPROVED	Fuji Electric Co., Ltd.	
DRAWN	Jun. - 2 - '00	<i>T. Nakagishi</i>		DWG. NO.	MS6M 0541
CHECKED	June - 2 - 00	<i>S. Matsumoto</i>	<i>T. Miyatake</i>		

Revised Records

Date	Classi- fication	Ind.	Content	Applied date	Drawn	Checked	Approved
Jun.-2-'00	enactment	—	—————	Issued date	—	S. M. A. a	T. Miyasaka

This material and the information herein is the property of Fuji Electric Co., Ltd. They shall be neither reproduced, copied, lent, or disclosed in any way whatsoever for the use of any third party nor used for the manufacturing purposes without the express written consent of Fuji Electric Co., Ltd.

7MBR15SA060D-01

1. Outline Drawing (Unit : mm)

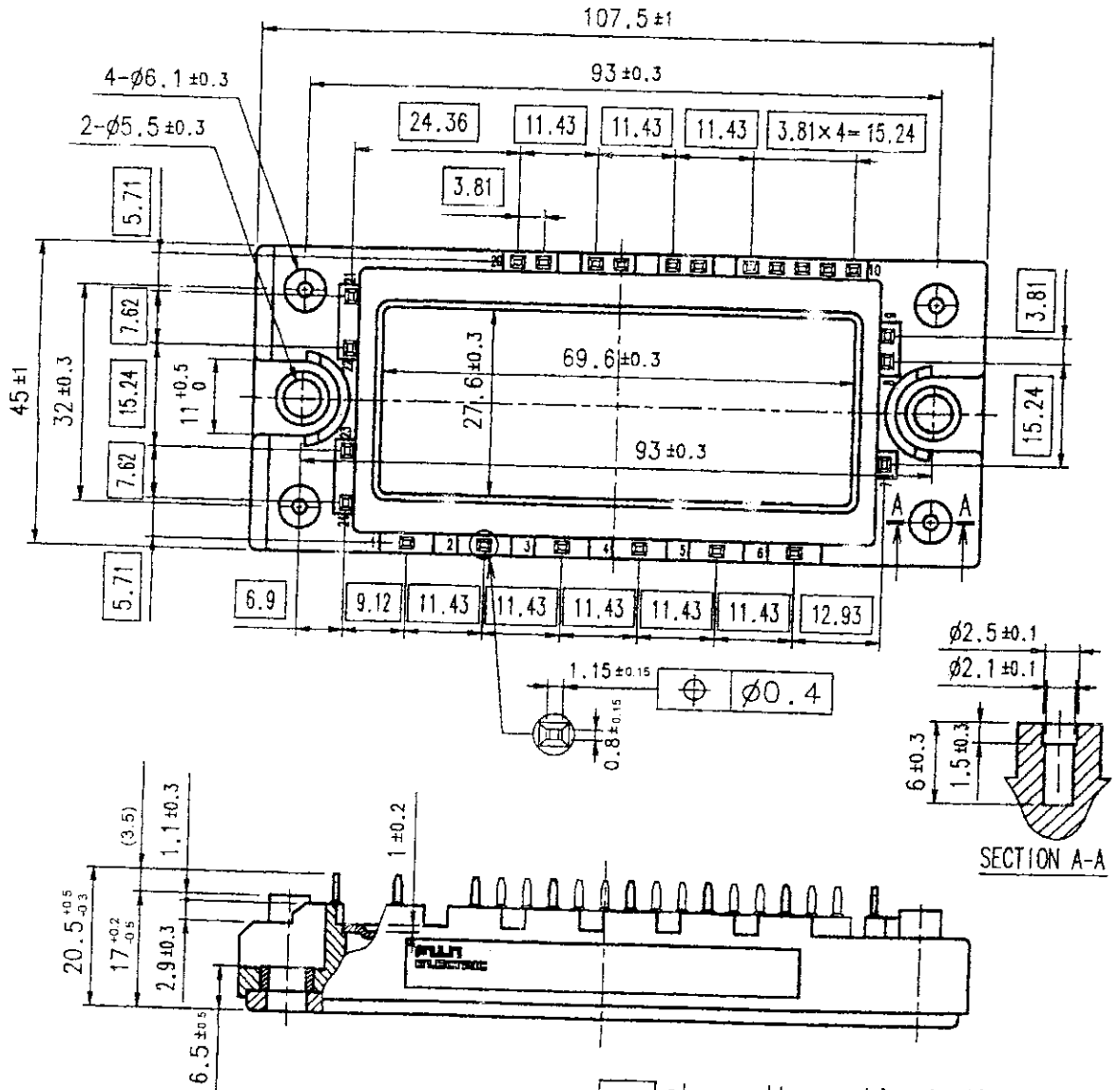

This material and the information herein is the property of Fuji Electric Co. Ltd. They shall be neither reproduced, copied, lent, or disclosed in any way whatsoever for the use of any third party nor used for the manufacturing purposes without the express written consent of Fuji Electric Co., Ltd.

□ shows theoretical dimension.

2. Equivalent circuit

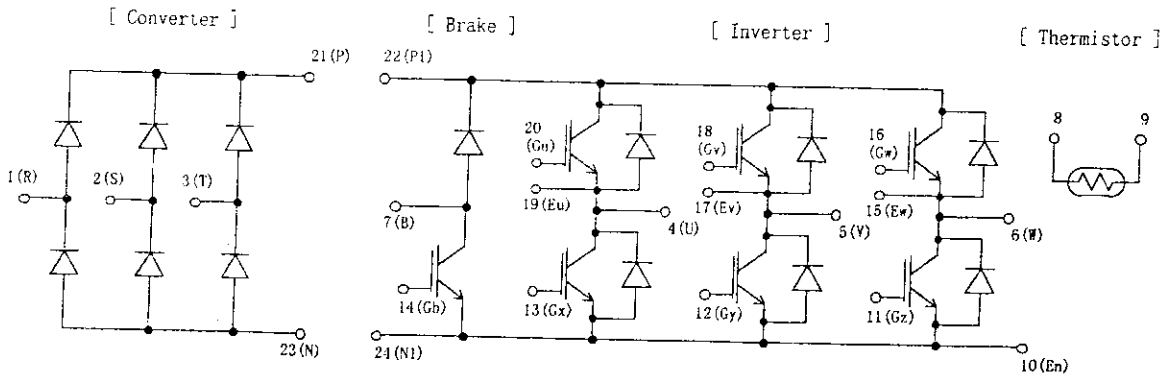

Fuji Electric Co., Ltd.

DWG. NO.

MS6M 0541

3 / 10

H04-004-03

3. Absolute Maximum Ratings (at Tc= 25C unless otherwise specified)

Items		Symbols	Conditions	Maximum Ratings	Units
Inverter	Collector-Emitter voltage	VCES		600	V
	Gate-Emitter voltage	VGES		+20	V
	Collector current	Ic	Continuous	20	A
		Icp	1ms	40	A
		-Ic		20	A
Collector Power Dissipation	Pc	1 device	80	W	
Brake	Collector-Emitter voltage	VCES		600	V
	Gate-Emitter voltage	VGES		+20	V
	Collector current	Ic	Continuous	20	A
		Icp	1ms	40	A
		Pc	1 device	50	W
	Repetitive peak reverse Voltage(Diode)	VRRM		600	V
Converter	Repetitive peak reverse Voltage	VRRM		800	V
	Average Output Current	Io	50Hz/60Hz sine wave	25	A
	Surge Current (Non-Repetitive)	IFSM	Tj=150C, 10ms	260	A
	I ² t (Non-Repetitive)	I ² t	half sine wave	338	A ² s
Junction temperature		Tj		150	C
Storage temperature		Tstg		-40~ +125	C
Isolation voltage	between terminal and copper base ^{(*)1}	Viso	AC : 1min.	2500	V
	between thermistor and others ^{(*)2}			2500	V
Mounting Screw Torque ^{(*)3}				3.5	Nm

(*)1 All terminals should be connected together when isolation test will be done.

(*)2 Terminal 8 and 9 should be connected together. Terminal 1 to 7 and 10 to 24 should be connected together and shorted to copper base.

(*)3 Recommendable Value : 2.5~3.5 Nm (M5)

This material and the information herein is the property of Fuji Electric Co., Ltd. They shall be neither reproduced, copied, lent, or disclosed in any way whatsoever for the use of any third party nor used for the manufacturing purposes without the express written consent of Fuji Electric Co., Ltd.

Fuji Electric Co., Ltd.

DWG. NO.

MS6M 0541

4 / 10

H04-004-03

This material and the information herein is the property of Fuji Electric Co., Ltd. They shall be neither reproduced, copied, lent, or disclosed in any way whatsoever for the use of any third party nor used for the manufacturing purposes without the express written consent of Fuji Electric Co., Ltd.

4. Electrical characteristics (at Tj= 25C unless otherwise specified)

Items	Symbols	Conditions	Characteristics			Units	
			min.	typ.	Max.		
Inverter	Zero gate voltage	ICES	VGE 0 V, VCE 600 V				
	Collector current	ICES	VGE 0 V, VCE 600 V			1.0 mA	
	Gate-Emitter leakage current	IGES	VCE 0 V, VGE +-20 V			200 nA	
	Gate-Emitter threshold voltage	VGE(th)	VCE 20 V, Ic = 20 mA	5.5	7.8	8.5 V	
	Collector-Emitter saturation voltage	VCE(sat)	VGE 15 V, Ic = 20 A	chip	1.8		V
				terminal	1.95	2.4	
	Input capacitance	Cies	VGE 0 V, VCE 10 V f = 1 MHz	3000			pF
	Turn-on time	ton	Vcc= 300 V		0.45	1.2	us
		tr	Ic = 20 A		0.25	0.6	
		tr(0)	VGE +-15 V		0.08		
	Turn-off time	toff	RG = 120 ohm		0.40	1.0	us
		tf			0.05	0.35	
Forward on voltage	VF	IF = 20 A	chip	1.8		V	
			terminal	1.95	2.6		
Reverse recovery time	trr	IF = 20 A			300	ns	
Brake	Zero gate voltage	ICES	VGE 0 V, VCE 600 V				
	Collector current	ICES	VGE 0 V, VCE 600 V			1.0 mA	
	Gate-Emitter leakage current	IGES	VCE 0 V, VGE +-20 V			200 nA	
	Collector-Emitter saturation voltage	VCE(sat)	VGE 15 V, Ic = 20 A	chip	1.8		V
				terminal	1.95	2.4	
	Turn-on time	ton	Vcc= 300 V		0.45	1.2	us
		tr	Ic = 20 A		0.25	0.6	
	Turn-off time	toff	VGE +-15 V		0.40	1.0	us
		tf	RG = 120 ohm		0.05	0.35	
	Reverse current	IRRM	VR = 600 V			1.0	mA
	Forward on voltage	VFM	IF = 20 A	chip	1.0		V
				terminal	1.1	1.5	
Reverse current	IRRM	VR = 800 V			1.0	mA	
Thermistor	Resistance	R	T = 25C	5000		ohm	
			T = 100C	465	495		520
	B value	B	T = 25/50C	3305	3375	3450	K

5. Thermal resistance characteristics

Items	Symbols	Conditions	Characteristics			Units
			min.	typ.	Max.	
Thermal resistance (1 device)	Rth(j-c)	Inverter IGBT			1.56	C/W
		Inverter FWD			3.00	
		Brake IGBT			2.50	
		Converter Diode			1.30	
Contact Thermal resistance	Rth(c-f)	with Thermal Compound (*)		0.05		C/W

* This is the value which is defined mounting on the additional cooling fin with thermal compound.

Fuji Electric Co.,Ltd.

DWG. NO.

MS6M 0541

5 / 10

This material and the information herein is the property of Fuji Electric Co. Ltd. They shall be neither reproduced, copied, lent, or disclosed in any way whatsoever for the use of any third party nor used for the manufacturing purposes without the express written consent of Fuji Electric Co., Ltd.

6. Indication on module

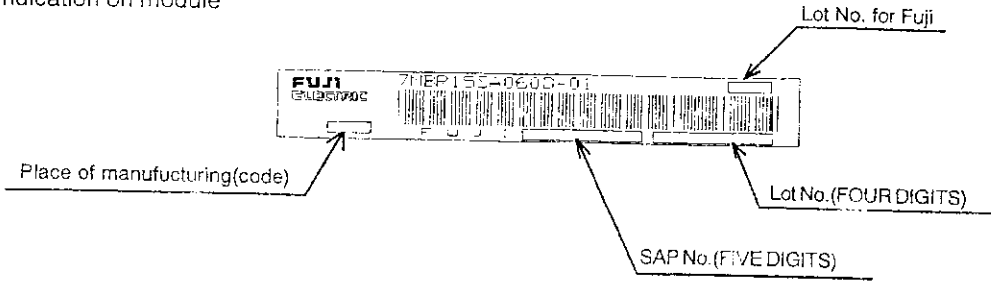

7. Applicable category

This specification is applied to Power Integrated Module named 7MBR15SA060D-01.

8. Storage and transportation notes

- The module should be stored at a standard temperature of 5 to 35°C and humidity of 45 to 75% .
- Store modules in a place with few temperature changes in order to avoid condensation on the module surface.
- Avoid exposure to corrosive gases and dust.
- Avoid excessive external force on the module.
- Store modules with unprocessed terminals.
- Do not drop or otherwise shock the modules when transporting.
- Please connect adequate fuse or protector of circuit between three-phase line and this product to prevent the equipment from causing secondary destruction.

9. Definitions of switching time

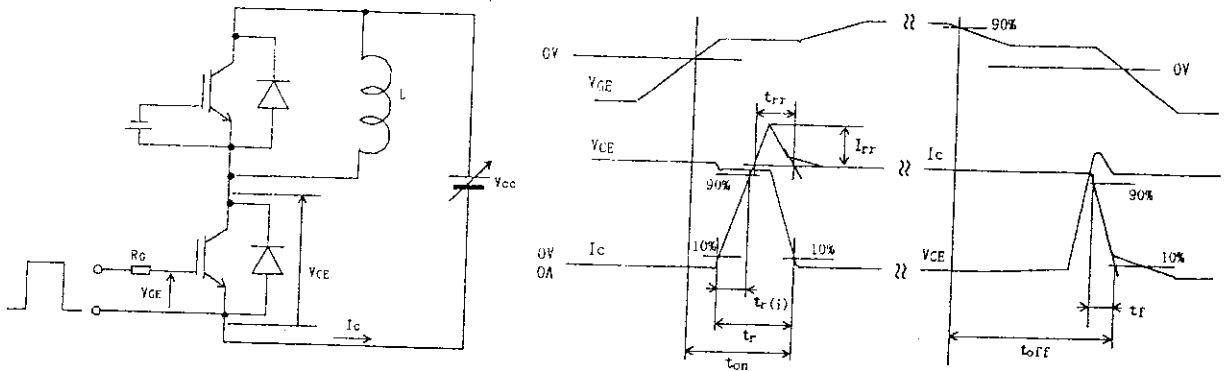

Fuji Electric Co., Ltd.

DWG NO

MS6M 0541

6 / 10

This material and the information herein is the property of Fuji Electric Co. Ltd. They shall be neither reproduced, copied, lent, or disclosed in any way whatsoever for the use of any third party nor used for the manufacturing purposes without the express written consent of Fuji Electric Co. Ltd.

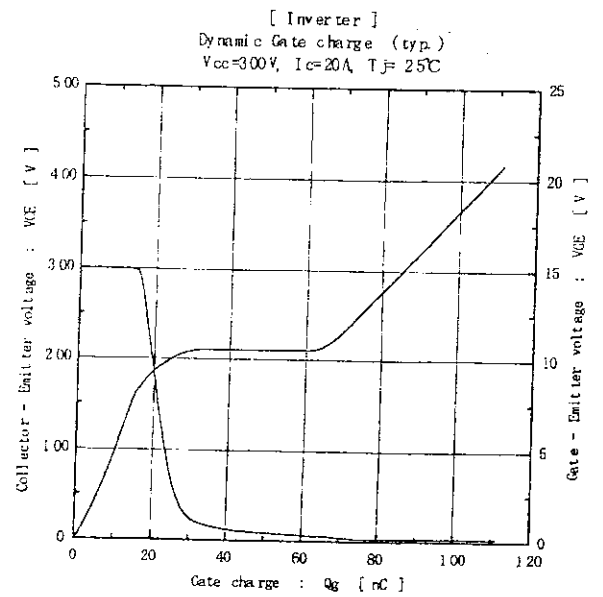
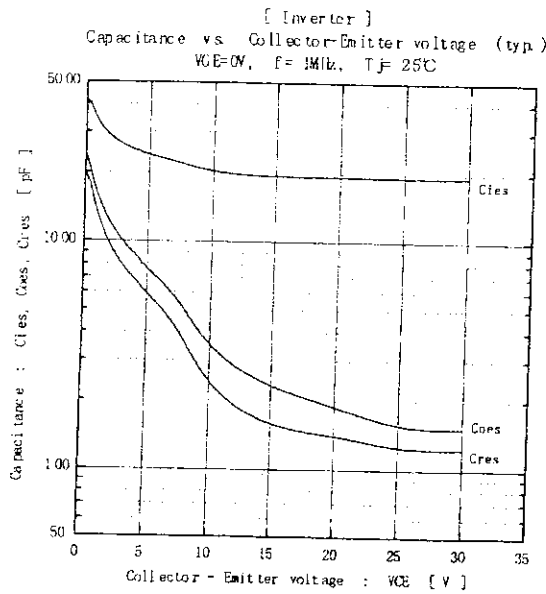
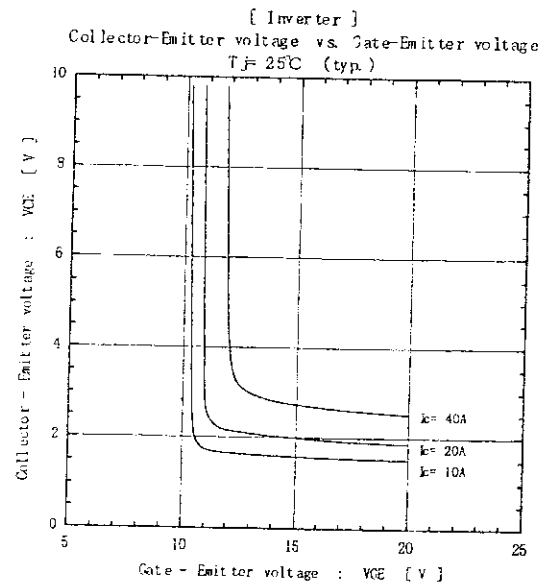
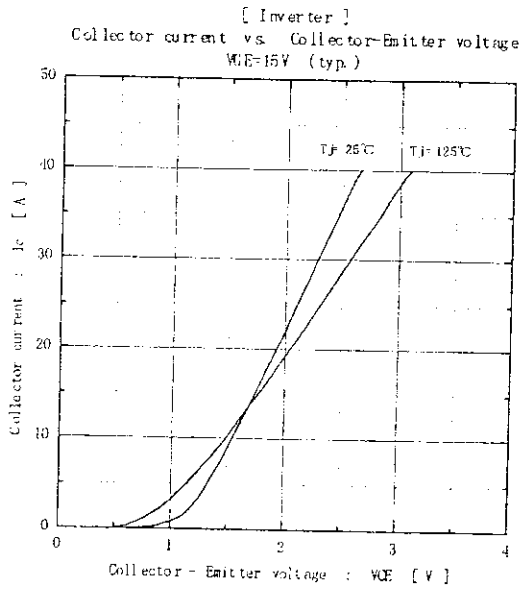
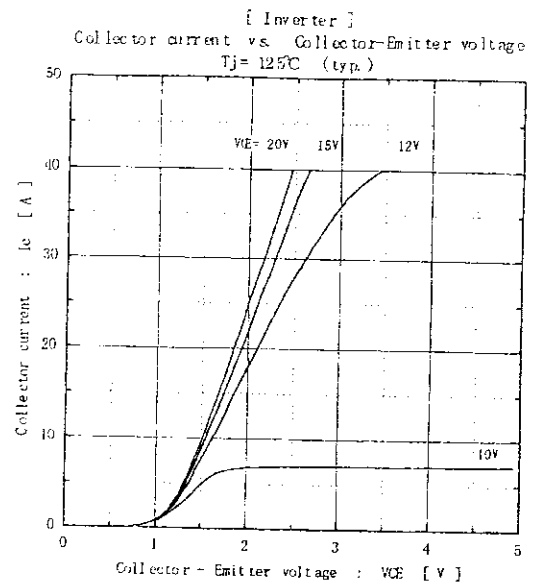
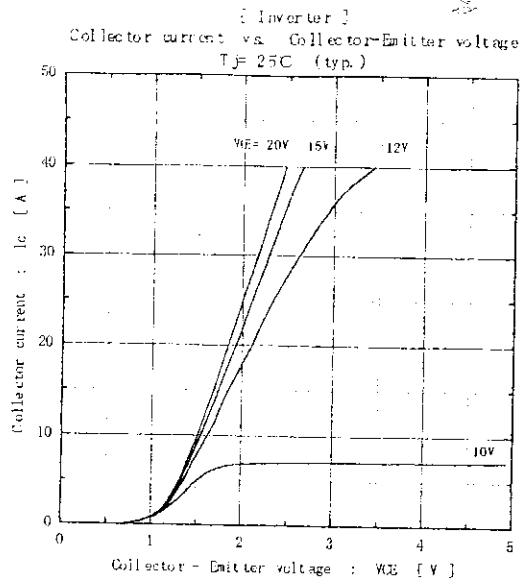

Fuji Electric Co., Ltd.

DWG. NO

MS6M 0541

7 / 10

This material and the information herein is the property of Fuji Electric Co. Ltd. They shall be neither reproduced, copied, lent, or disclosed in any way whatsoever for the use of any third party nor used for the manufacturing purposes without the express written consent of Fuji Electric Co. Ltd.

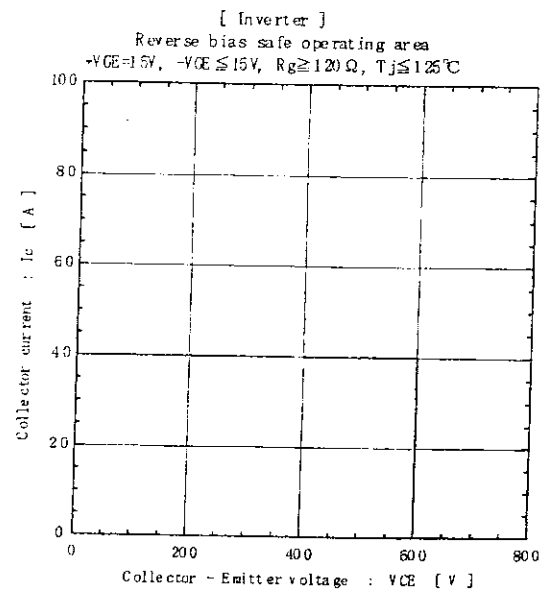
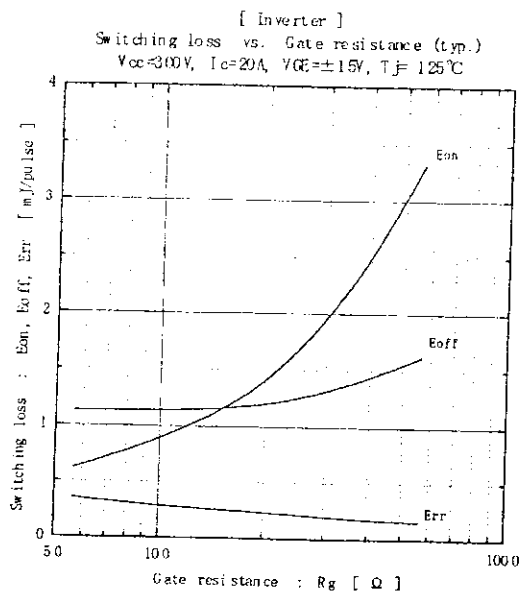
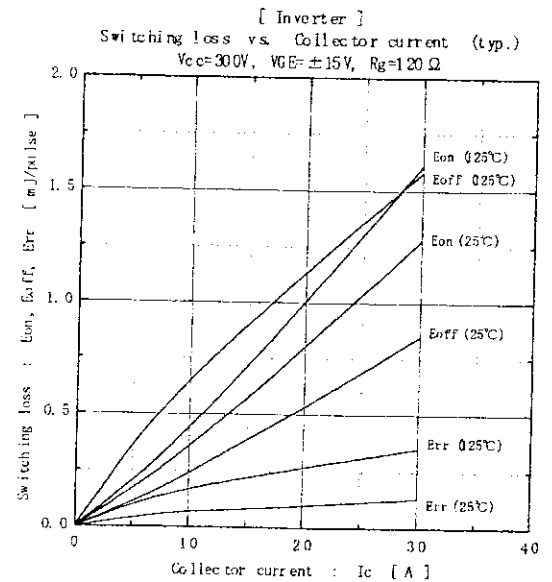
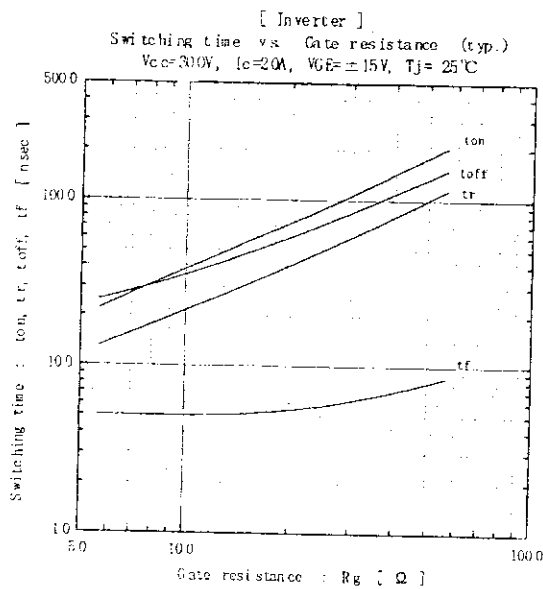
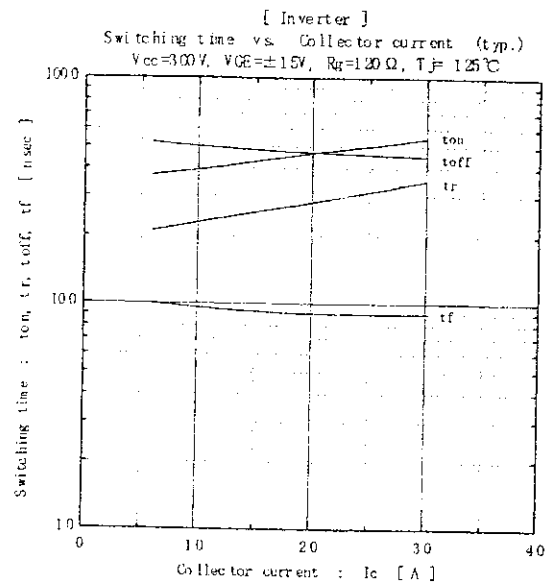
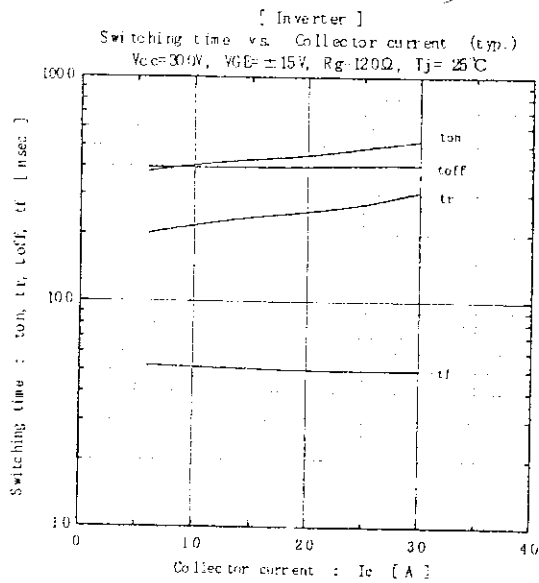

Fuji Electric Co., Ltd.

DWG. NO.

MS6M 0541

8/10

H04-004-03

This material and the information herein is the property of Fuji Electric Co. Ltd. They shall be neither reproduced, copied, lent, or disclosed in any way whatsoever for the use of any third party nor used for the manufacturing purposes without the express written consent of Fuji Electric Co., Ltd.

[Inverter]
Forward current vs. Forward on voltage (typ.)

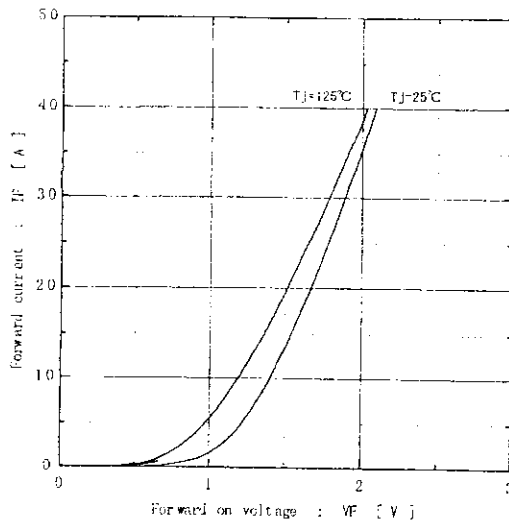

[Inverter]
Reverse recovery characteristics (typ.)
 $V_{cc}=300V, V_{GE}=\pm 15V, R_g=120\Omega$

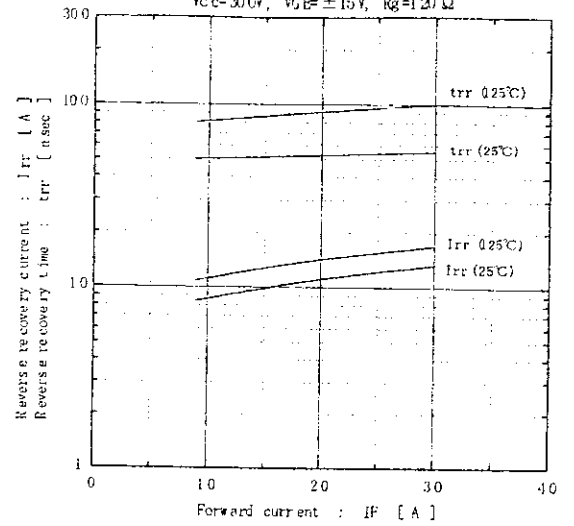

[Converter]
Forward current vs. Forward on voltage (typ.)

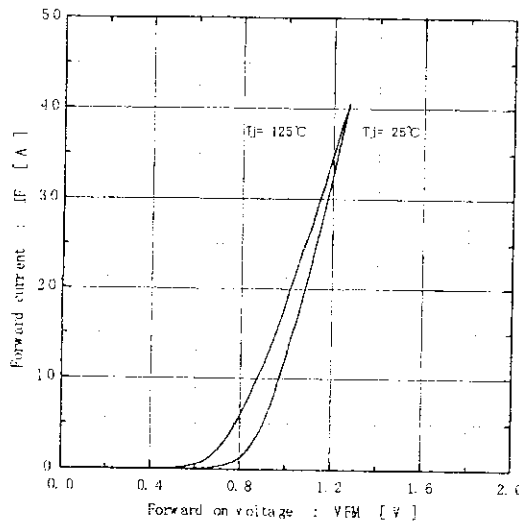

Transient thermal resistance

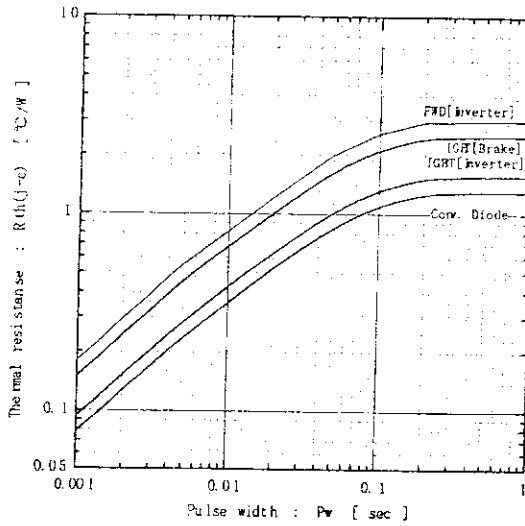

[Thermistor]
Temperature characteristic (typ.)

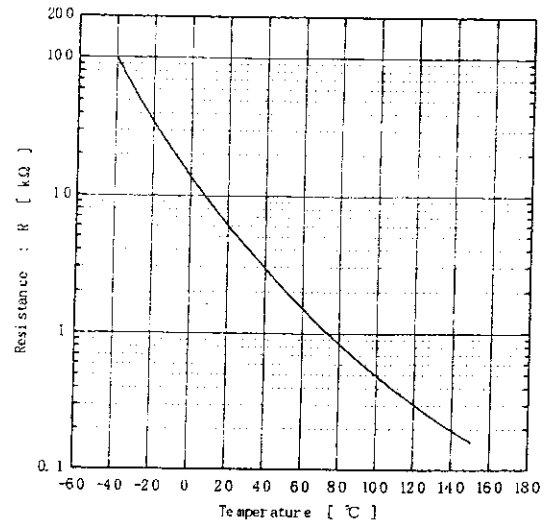

Fuji Electric Co., Ltd.

DWG. NO.

MS6M 0541

9/10

H04-004-03

This material and the information herein is the property of Fuji Electric Co. Ltd. They shall be neither reproduced, copied, lent, or disclosed in any way whatsoever for the use of any third party nor used for the manufacturing purposes without the express written consent of Fuji Electric Co., Ltd.

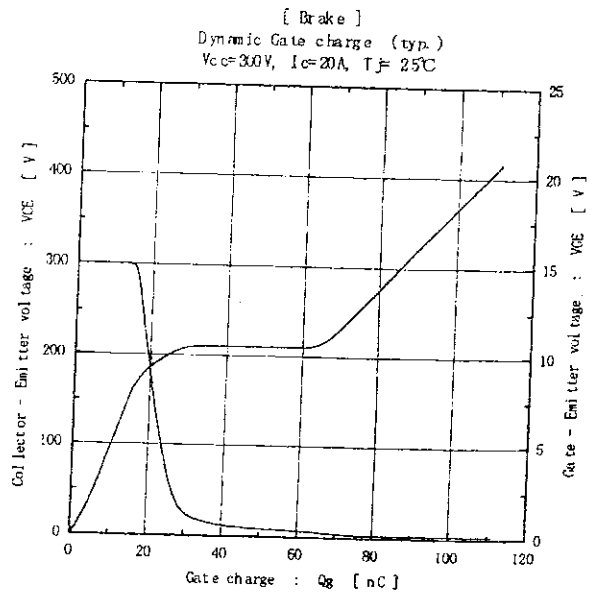
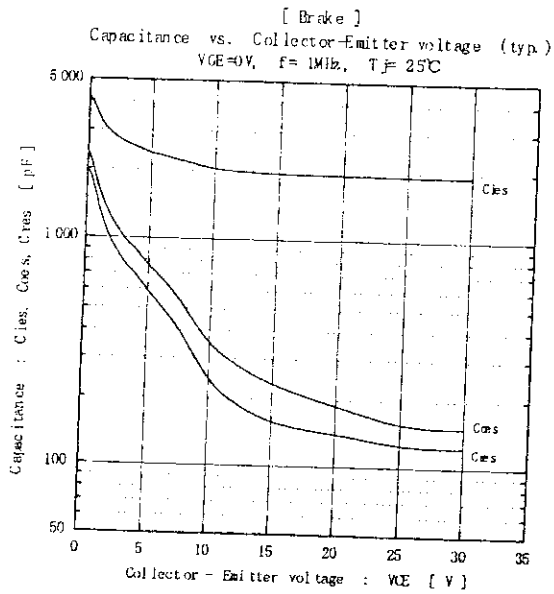
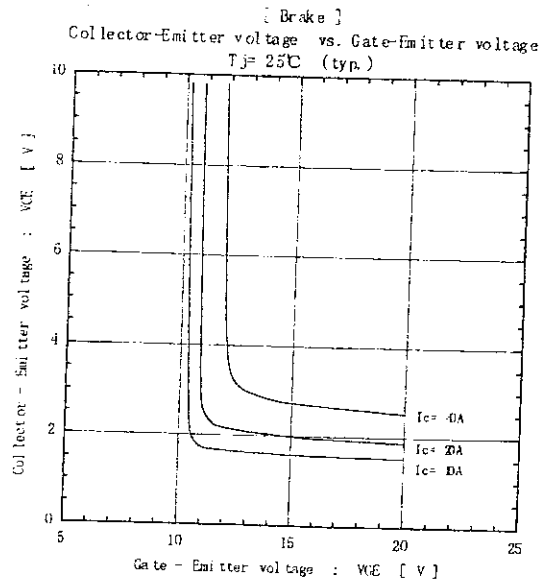
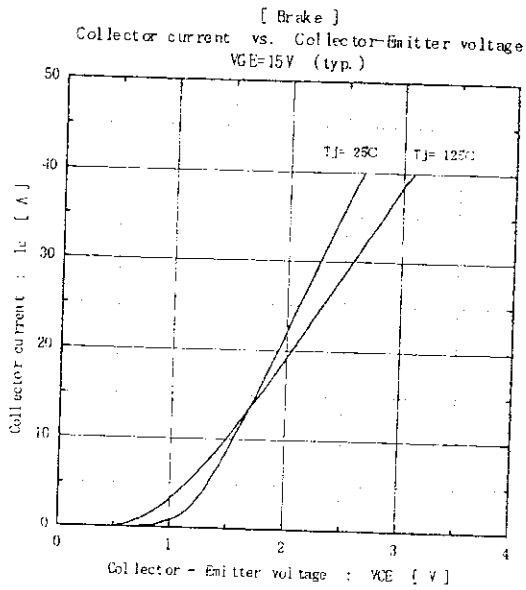
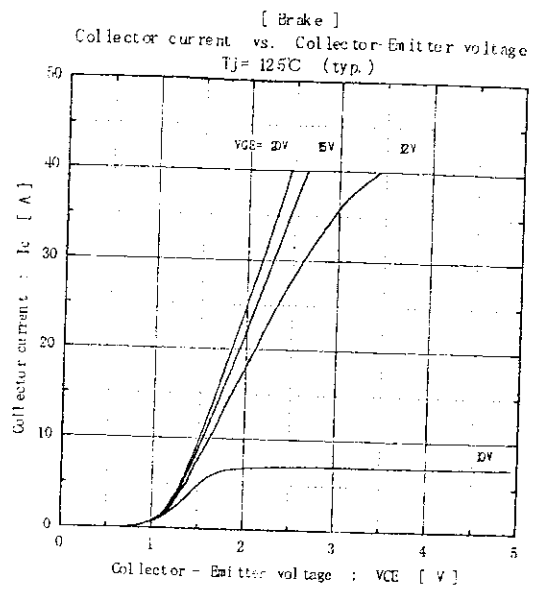
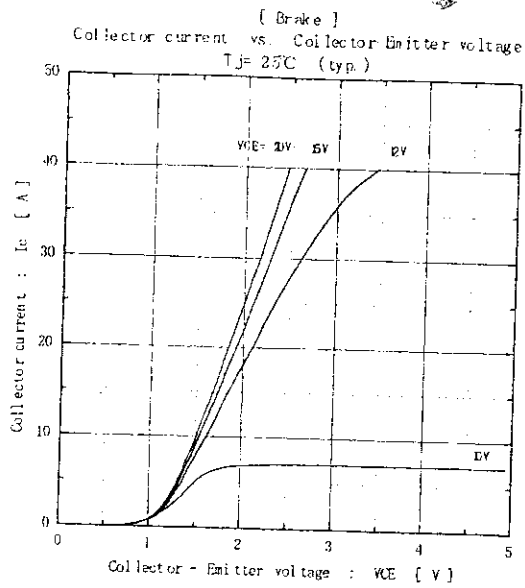

Fuji Electric Co., Ltd.

DWG. NO.

MS6M 0541

10 / 10

H04-004-03