



Dual 1 Form A
Solid State Relay

DESCRIPTION

The AD4C111-L is a bi-directional, double-pole, single-throw, normally open multipurpose solid-state relay. It is designed to replace electromechanical relays in general purpose switching applications. The relay consists of two integrated circuits, each driving a pair of rugged source-to-source enhancement type DMOS transistors. Each integrated circuit is optically coupled to a light emitting diode. This device also includes current-limiting circuitry. During increased load currents or transient current spikes, this circuitry acts to bring the current down, protecting downstream components.

FEATURES

- High input-to-output isolation
- Low input control power consumption
- 110mA maximum continuous load current
- 40 ohms maximum on-resistance
- Long life/high reliability
- Current limiting

APPLICATIONS

- Telecom switching
- Tip/Ring control
- PCMCIA modules
- Multiplexers
- Meter reading systems
- Data acquisition
- Medical equipment
- Battery monitoring
- Home/Safety security systems

OPTIONS/SUFFIXES

- -S Surface Mount Option
- -TR Tape and Reel

SCHEMATIC DIAGRAM

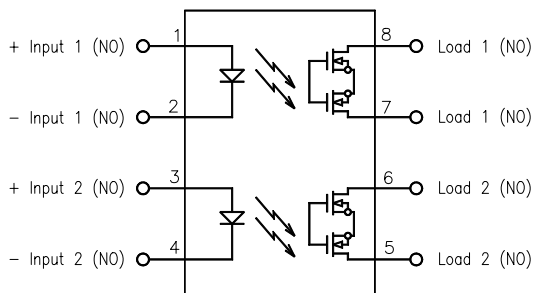

MAXIMUM RATINGS

PARAMETER	UNIT	MIN	TYP	MAX
Storage Temperature	°C	-55		125
Operating Temperature	°C	-40		85
Continuous Input Current	mA			40
Transient Input Current	mA			400
Reverse Input Control Voltage	V	6		
Output Power Dissipation	mW			500

APPROVALS

- BAPT CERTIFICATE #607836:
BS EN 60950, BS EN 41003, BS EN 60065
- CSA CERTIFICATE #LR111581-1
- UL FILE #E90096



Dual 1 Form A
Solid State Relay

ELECTRICAL CHARACTERISTICS - 25°

PARAMETER	UNIT	MIN	TYP	MAX	TEST CONDITIONS
INPUT SPECIFICATIONS					
LED Forward Voltage	V		1.2	1.5	If = 10mA
LED Reverse Voltage	V	6	12		Ir = 10uA
Turn-On Current	m A	5	2.5		Io = 110mA
Turn-Off Current	m A		0.5		
OUTPUT SPECIFICATIONS					
Blocking Voltage	V	400			Io = 10uA
Continuous Load Current	m A			110	If = 5mA
Current Limit	m A	120	150	180	If = 5mA
On-Resistance	Ω		30	40	Io = 110mA
Leakage Current	μ A		0.2	10	Vo = 400V
Output Capacitance	p F		25	50	Vo = 25V, f = 1.0MHz
Offset Voltage	m V			0.2	If = 5mA
COUPLED SPECIFICATIONS					
Isolation Voltage	V	2500			T = 1 minute
-H Suffix	V	3750			T = 1 minute
Turn-On Time	m s		0.5	1	If = 5mA, Io = 110mA
Turn-Off Time	m s		0.1	0.5	If = 5mA, Io = 110mA
Isolation Resistance	G Ω	100			
Coupled Capacitance	p F		3		
Contact Transient Ratio	V / μ s	2000	7000		dV = 50V



Dual 1 Form A
Solid State Relay

PERFORMANCE DATA

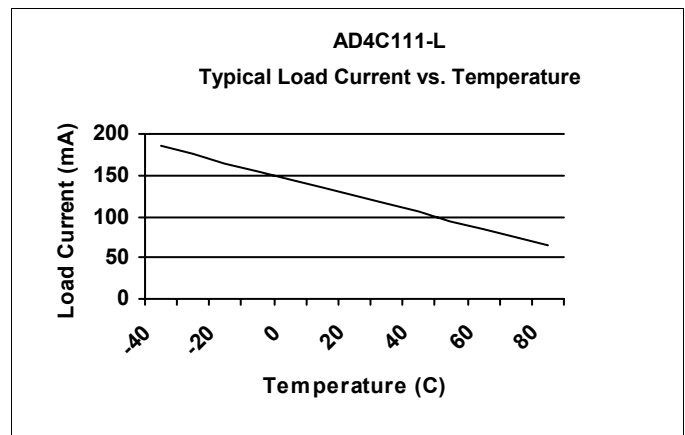
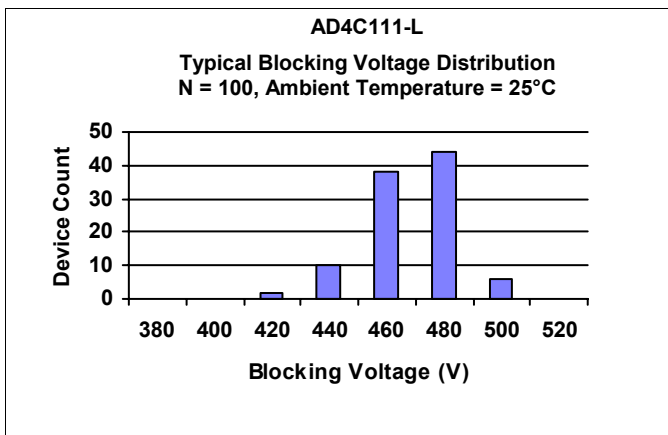
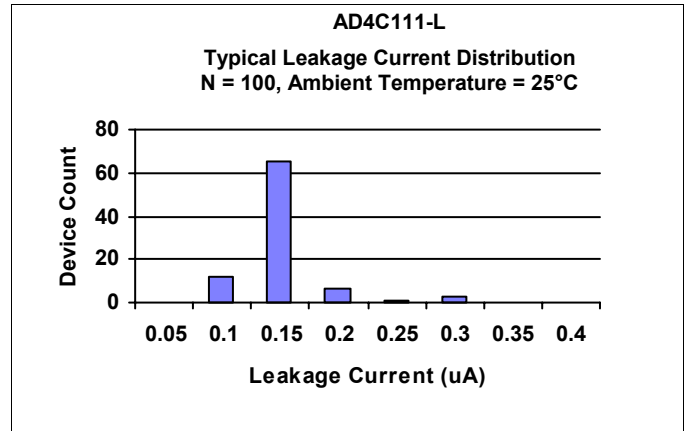
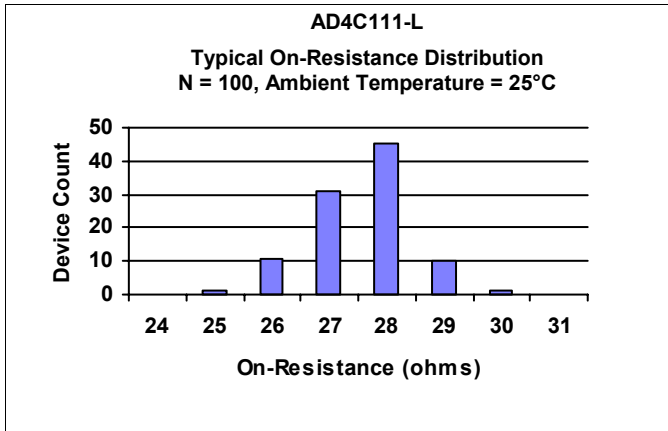
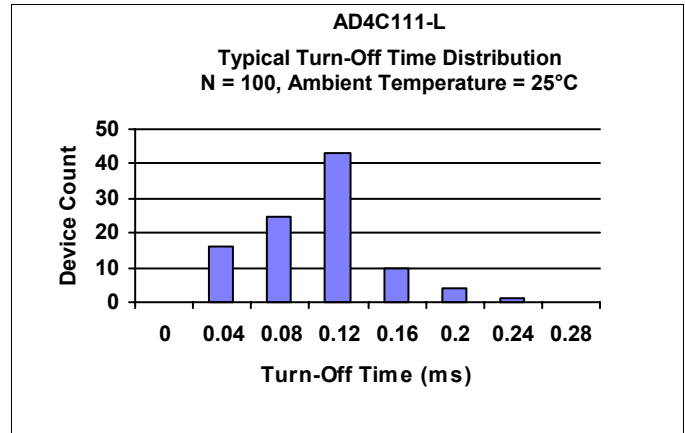
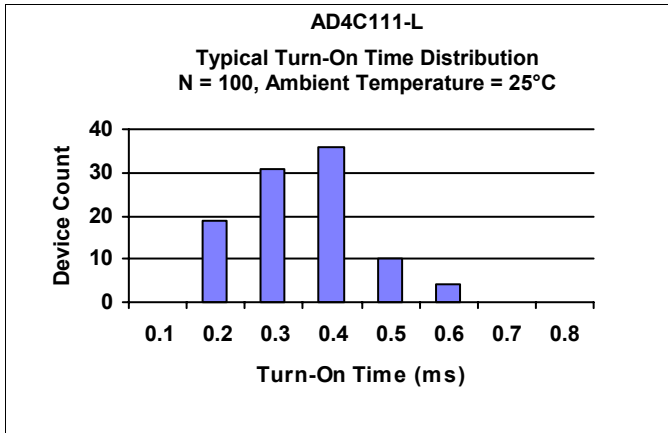



Dual 1 Form A
Solid State Relay

MECHANICAL DIMENSIONS

8 PIN DUAL IN-LINE PACKAGE

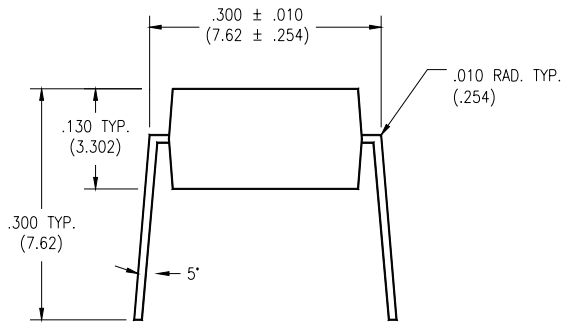

END VIEW

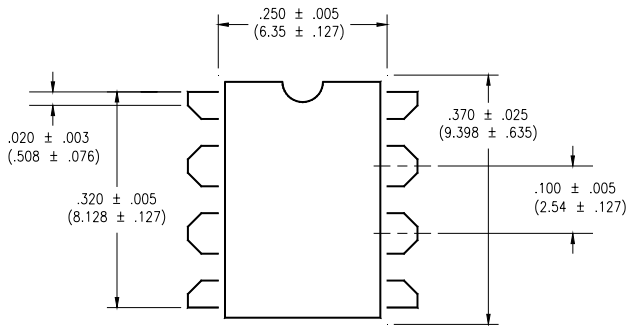

TOP VIEW

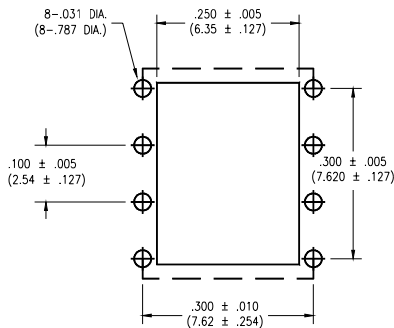

**BOTTOM VIEW/
BOARD PATTERN**

8 PIN SURFACE MOUNT DEVICE

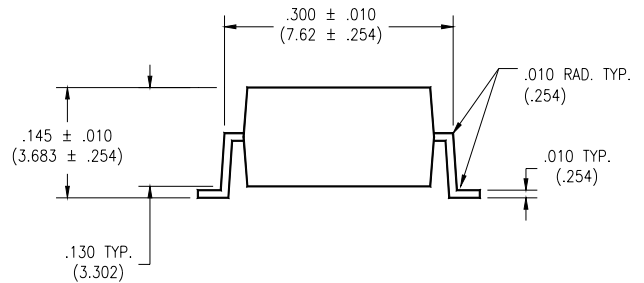

END VIEW

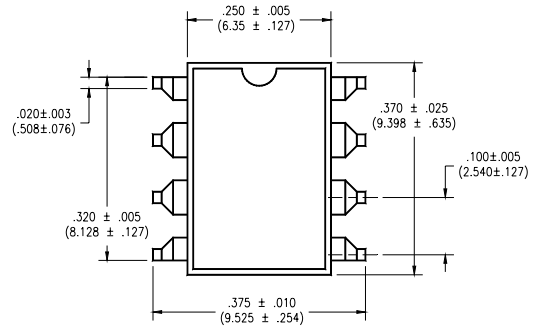

TOP VIEW

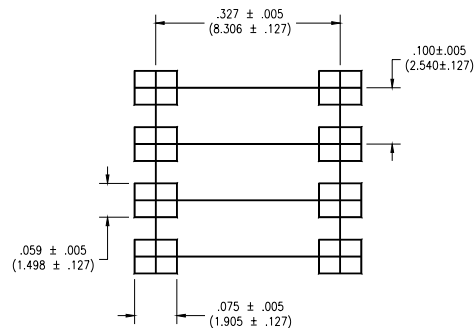

**BOTTOM VIEW/
BOARD PATTERN**